

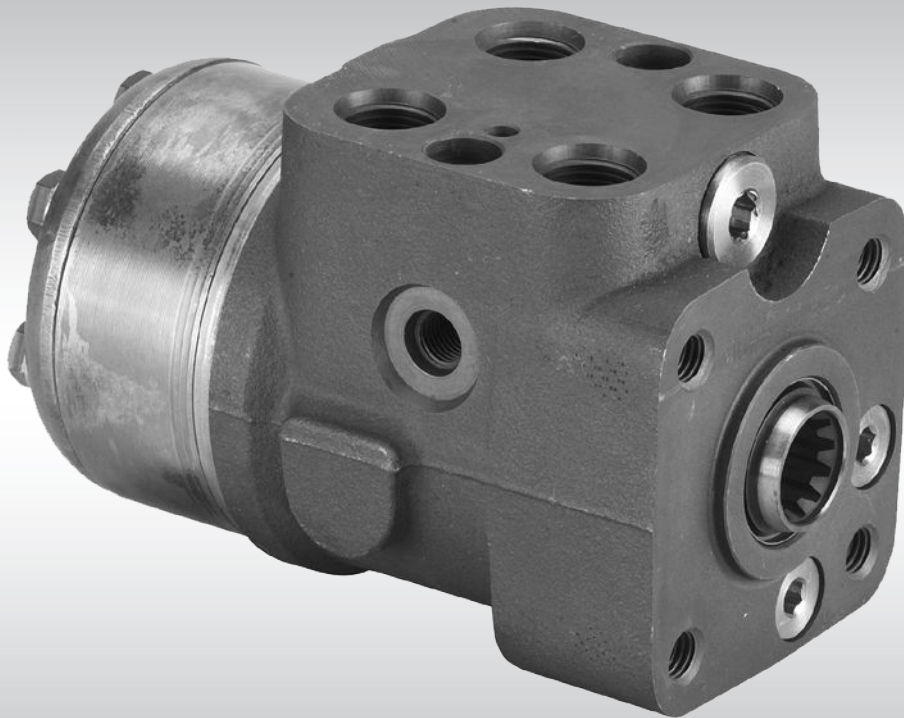

Service Manual  
Steering Unit  
Type OSPB, OSPC and OSPF



**Revision History***Table of Revisions*

<b>Date</b>	<b>Changed</b>	<b>Rev</b>
Mar 2014	Converted to Danfoss layout - DITA CMS	CA
Aug 2011	Drawing	BG
May 2011	Hexagon size	BF
Sep 2010	New back cover	BE
Jan 2010	Japan location	BD
Dec 2008	Tightening torque changed	BC

**Contents**

**Exploded View and Seal Kit**

Exploded View OSPB..... 4  
 Exploded View OSPC / OSPF..... 5

**Tools**

Tools..... 7

**Dismantling**

Dismantling..... 10  
 Dismantling the pressure relief valve for OSPC..... 16  
     Dismantling..... 16  
     Dismantling the pressure relief valve ..... 18  
 Cleaning..... 18  
 Lubrication..... 18  
 Inspection and Replacement..... 18

**Assembly**

Assembling..... 19  
     Assemble spool and sleeve..... 20  
     OSPB LS, OSPBX LS, OSPC LS, OSPC LSR and OSPF..... 20  
     OSPB CN and OSPC CN..... 20  
 Assembly Pattern for Bearings..... 22  
     Assembling Pattern for Standard Bearing..... 22  
     Assembly Pattern for Double Bearing..... 22  
 Installation Instructions for O-ring / Kin-ring / Roto glyd..... 23  
 Installation Instructions for Lip Seal..... 24  
 Assembly of the Pressure Relief Valve for OSPC..... 31  
 Assambly of the Shock Valves for OSPC/OSPC LS/OSPC LSR..... 32

**Maximum Tightening Torque and Hydraulic Connections**

Maximum Tightening Torque and Hydraulic Connections..... 35

Exploded View and Seal Kit

Exploded View OSPB

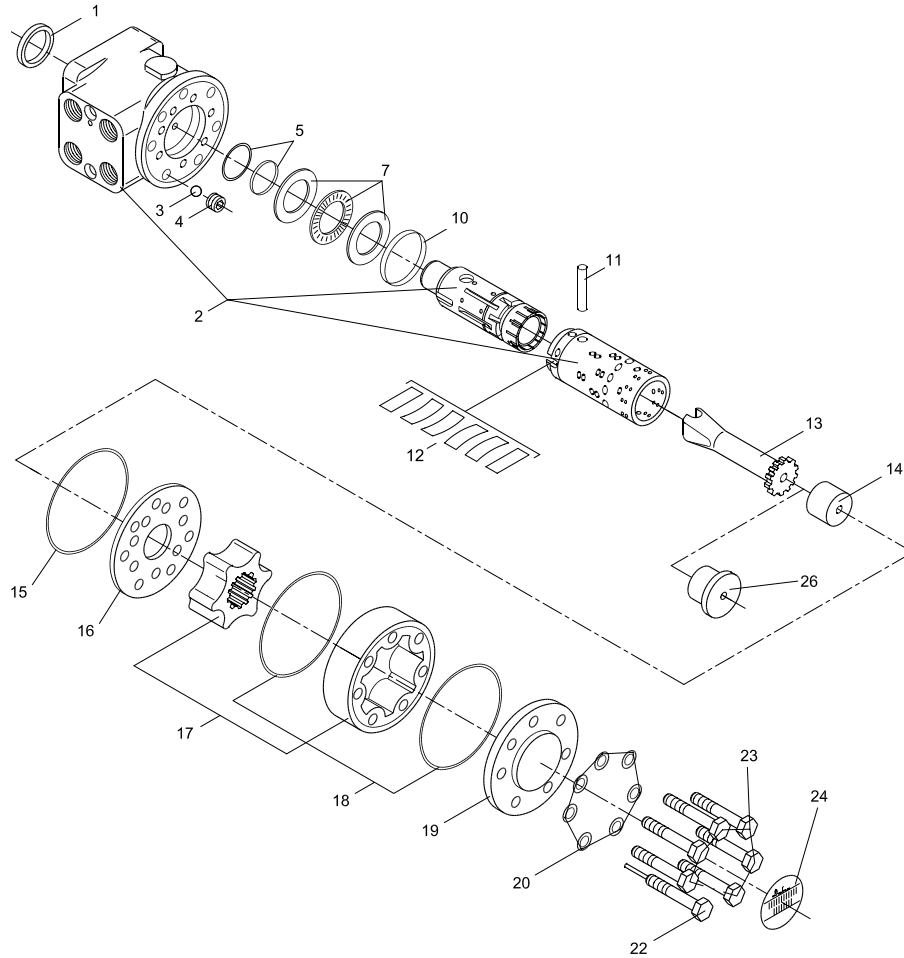

150-385,10

Exploded View OSPB Callouts

Callout	Description	Callout	Description
1	Dust seal ring	15	O-ring 80,5 • 1,5 mm [3.17 • 0.06 in]
2	Housing + spool + sleeve	16	Distributor plate
3	Ball 8.5 mm [0.33 in]	17	Gearwheel
4	Thread bushing	18	O-ring 75.92 • 1,78 mm [2.99 • 0.07 in]
5	O-ring with kin-ring or Roto Glyd	19	End cover
7	Bearing assembly	20	Washer 8.2 • 11,9 • 1.0 mm [0.32 • 0.47 • 0.04 in]
10	Ring for springs	22	Special screw
11	Cross pin 6 • 41 mm [0.24 • 1.61 in]	23	Screw
12	Neutral position springs	24	Name label
13	Cardan shaft	26	Spacer
14	Spacer		

Exploded View and Seal Kit

Exploded View OSPC / OSPF

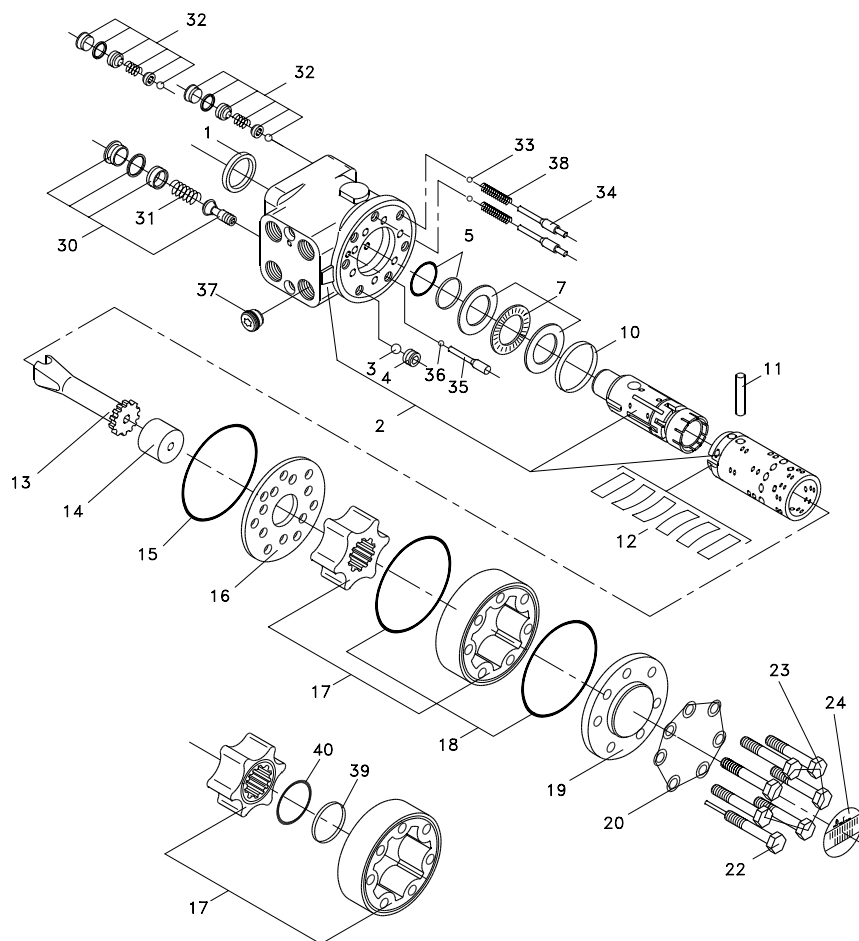

150-454.10

Exploded View OSPC / OSPF Callouts

Callout	Description	Callout	Description
1	Dust seal ring	19	End cover
2	Housing, spool and sleeve. Check valve and the seats for relief and shock valves are locktited.	20	Washer
3	Ball 8.5 mm [0.33 in]	22	Special screw
4	Thread bushing	23	Screw
5	O-ring used with kin-ring (item 6)	24	Name plate
6	Kin-ring	30	Complete relief valve
7	Bearing assembly	31	Spring wire
10	Ring	32	Complete shock valve
11	Cross pin	33	Ball 3/16 in
14	Spacer	38	Spring
13	Cardan shaft	34	Rolled pin

**Exploded View and Seal Kit**
*Exploded View OSPC / OSPF Callouts (continued)*

<b>Callout</b>	<b>Description</b>	<b>Callout</b>	<b>Description</b>
12	Set of springs	36	Bushing
15	O-ring	35	Ball
16	Distributor plate	39	Kin ring
17	Gearwheel set	40	O-ring
18	O-ring		

Tools

Tools

Holding tool

Code number: SJ 150-9000-2

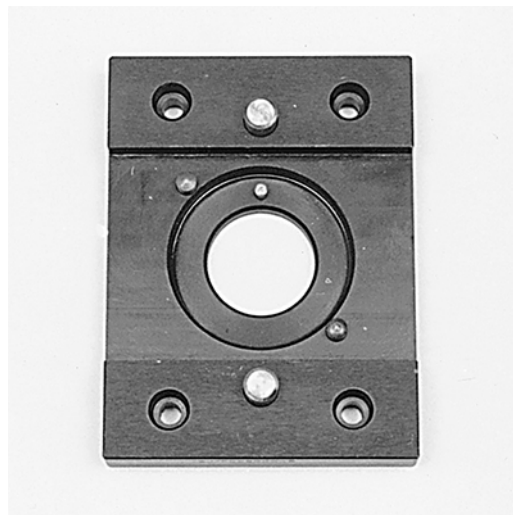

F300 937

Guide ring

Code number: SJ 150-9000-16



F301 015

Assembly tool for O-ring and kin-ring /

Roto Glyd

Code number: SJ 150-9000-11

Code number: SJ 150N4014-1



F300 940

Tools

Assembly tool for lip seal

Code number: SJ 150-9000-17

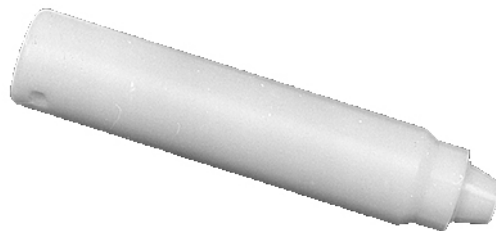

F300 944

Assembly tool for cardan shaft.

Code number: SJ 150-9000-3



F300 945

Assembly tool for dust seal.

Code number: SJ 150-9000-22



F300 946



## Tools

Torque wrench 0 - 70 N.m.

13 mm socket spanner.

6.8 and 12 mm sockets.

12 mm screwdriver.

2 mm [0.08 in] screwdriver.

13 mm ring spanner.

6.8 and 12 mm socket spanners.

Plastic hammer.

Tweezers.

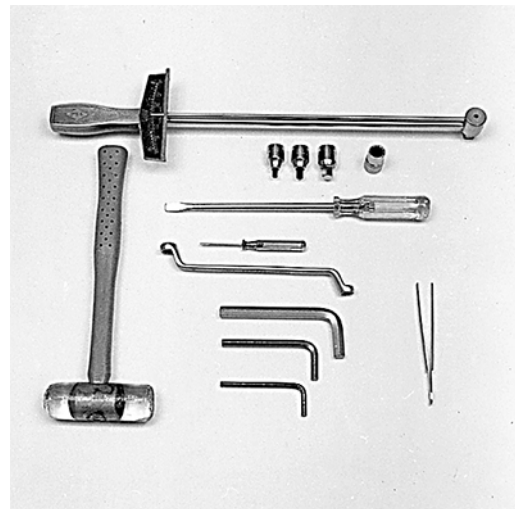

F300 939

The tools are not available from Danfoss

Dismantling

Dismantling

Dismantle steering column from steering unit and place the steering unit in the holding tool.

Screw out the screws in the end cover (6-off plus one special screw).

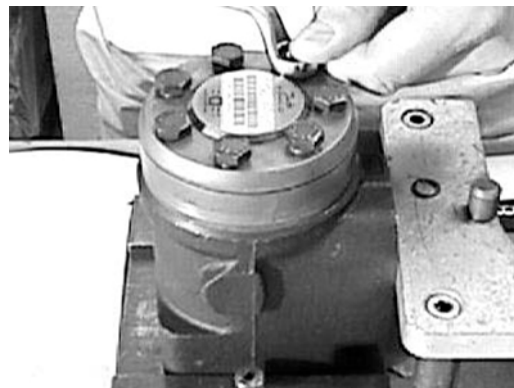

F300 947

Remove the end cover, sideways.

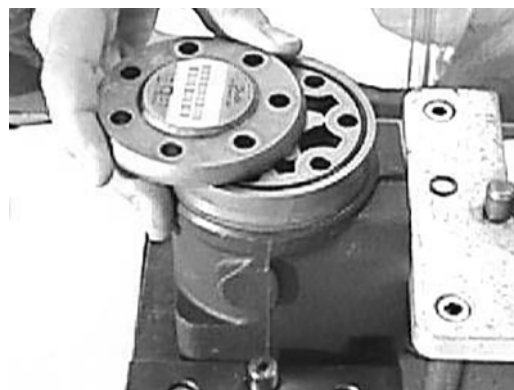

F300 948

Lift the gearwheel set (with spacer if fitted) off the unit. Take out the two O-rings.

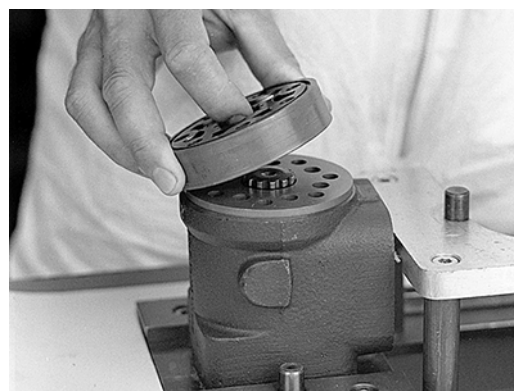

F300 949

Dismantling

Remove the cardan shaft

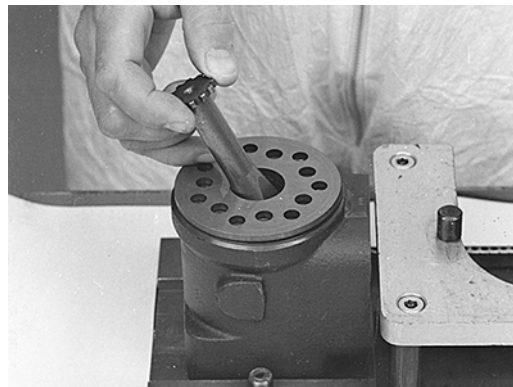

F300 950

Remove distributor plate.

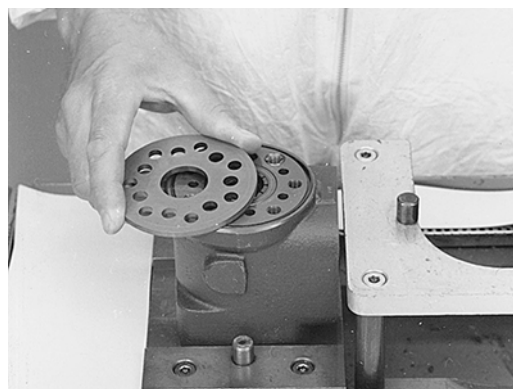

F300 951

Screw out the threaded bush over the check valve.

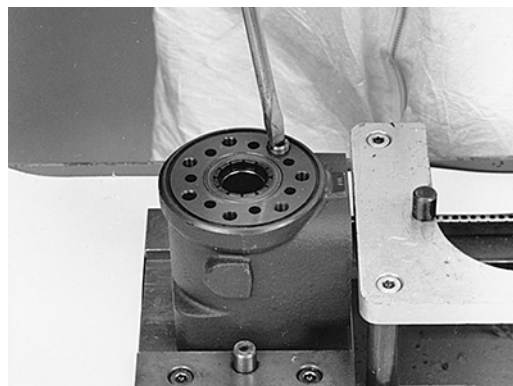

F300 953

Dismantling

Remove O-ring

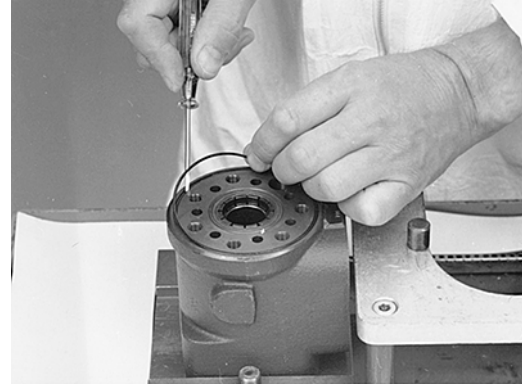

F300 952

OSPB, OSPB LS, OSPBX LS:

Shake out the check valve ball (Ø8 mm)

OSPC LS, OSPC LSR:

Shake out the check valve ball and suction valve pins and balls.

On some pins in the OSPC there are two springs (see page 4, pos. 38). Replace this pins prior to the reassembly!

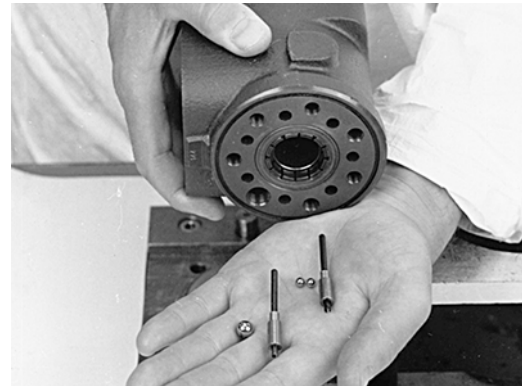

F300 954

Take care to keep the cross pin in the sleeve and spool horizontal. The pin can be seen through the open end of the spool. Press the spool inwards and the sleeve, ring, bearing races and needle bearing will be pushed out of the housing together.

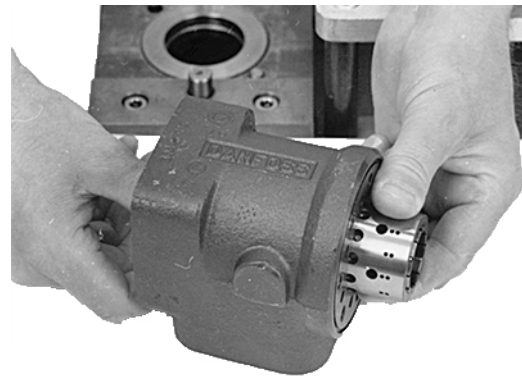

F300 955

Dismantling

Take ring, bearing races and needle bearing from sleeve and spool. The outer (thin) bearing race can sometimes “stick” in the housing, therefore check that it has come out.



F300956

Press out the cross pin. Use the special screw from the end cover.

Note next point/paragraph!

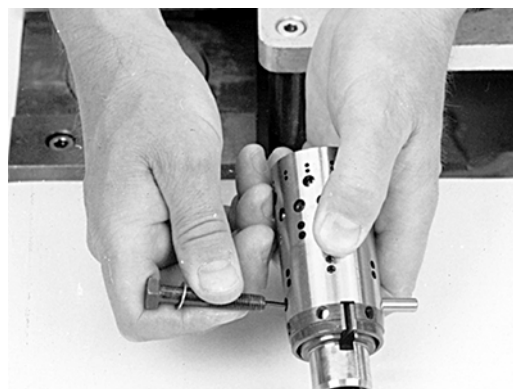

F300957

OSPB CN and OSPC CN

A small mark has been made with a pumice stone on both spool and sleeve close to one of the slots for the neutral position springs (see drawing).

If the mark is not visible, remember to leave a mark of your own on sleeve and spool before the neutral position springs are dismantled.

For OSPF both marks should be placed opposite each other!

CN

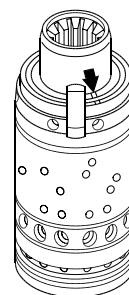

150-412.10

Dismantling

OSPF



F301 014

Carefully press the spool out of the sleeve.

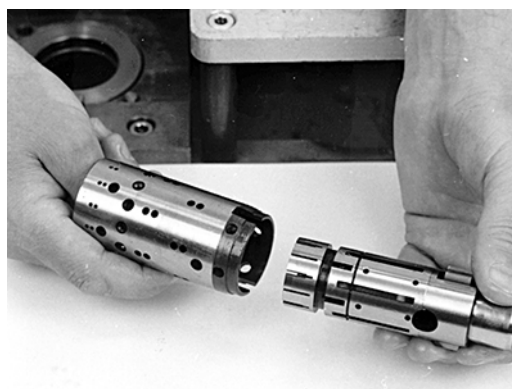

F300 958

Press the neutral position springs out of their slots in the spool.



F300 959

Dismantling

Remove dust seal and O-ring / Kin-ring / Roto Glyd.

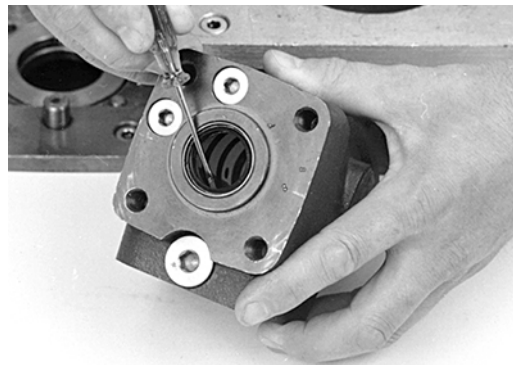

F300960

Remove plugs from shock valves using a 6 mm hexagon socket spanner

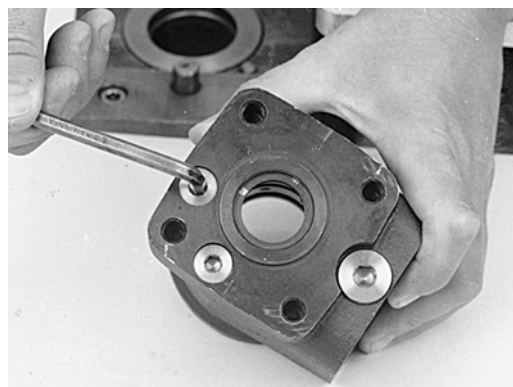

F300961

Remove seal washers (2-off).

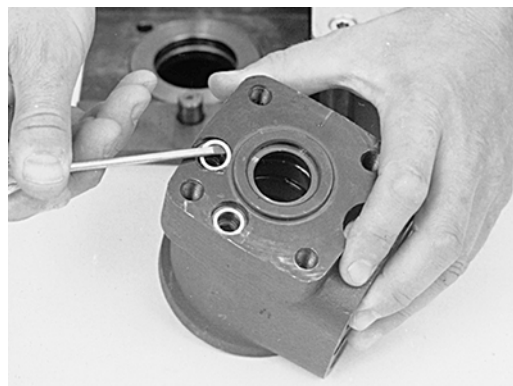

F300962

Dismantling

Unscrew the setting screws using a 6 mm hexagon socket spanner.

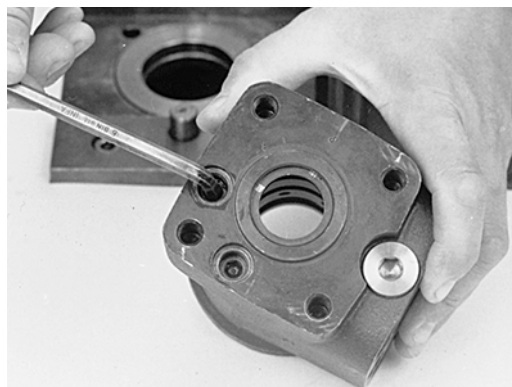

F300 963

Shake out the two springs and two valve balls into your hand. The valve seats are bonded into the housing and cannot be removed.

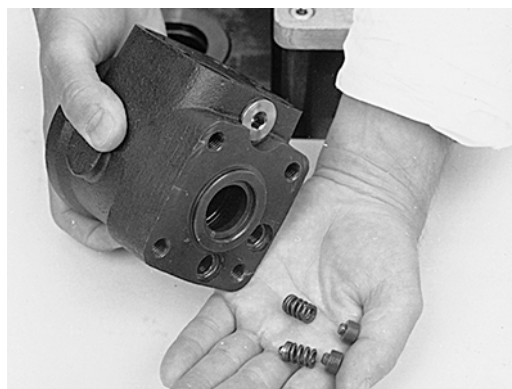

F300 964

The shock valves are now dismantled.

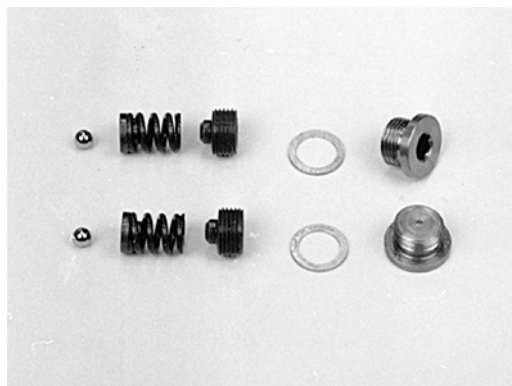

F300 965

**Dismantling the pressure relief valve for OSPC**

***Dismantling***

Dismantling the Pressure Relief Valve for OSPC



Dismantling

Screw out the plug using an 8 mm hexagon socket spanner. Remove seal washers .

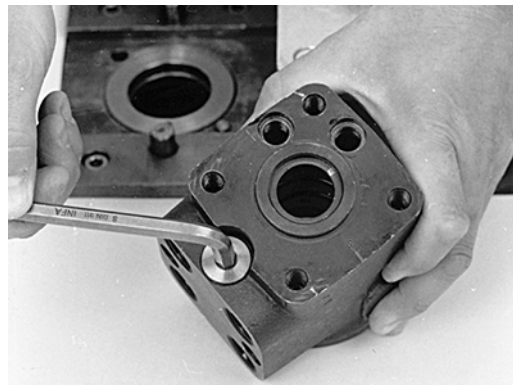

F300966

Unscrew the setting screw using an 6 mm hexagon socket spanner.

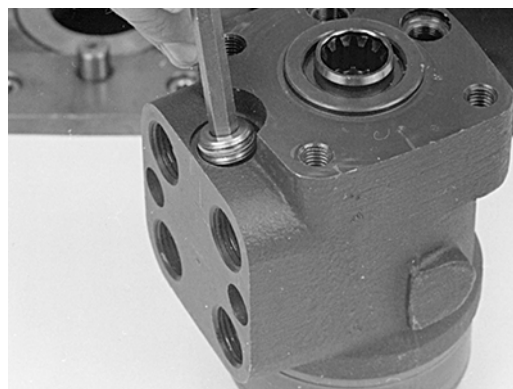

F300968

Shake out spring and piston. The valve seat is bonded into the housing and cannot be removed.

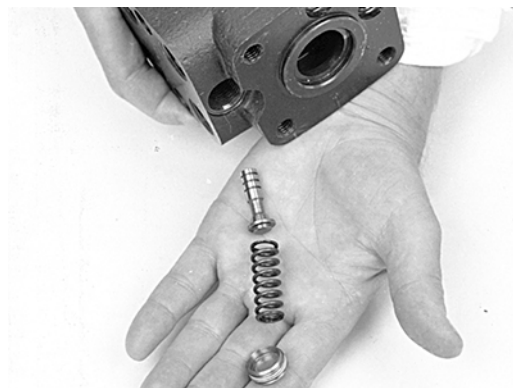

F300942

Dismantling

The pressure relief valve is now dismantled.

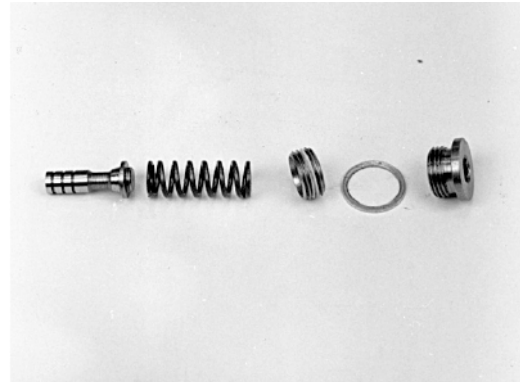

F300 967

**Dismantling the pressure relief valve**

Dismantling OSPC

The steering unit OSPC is now completely dismantled.

Replace this pins prior to the reassembly!

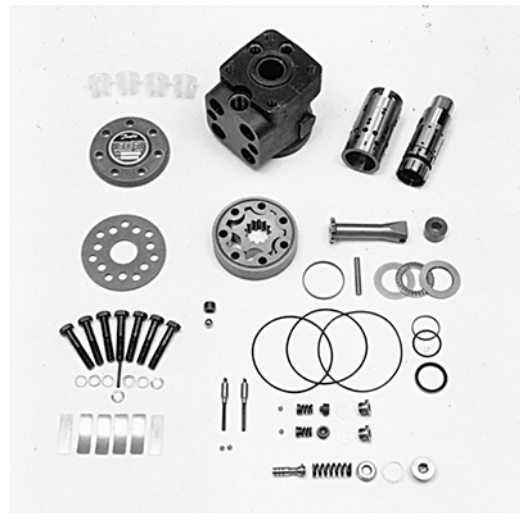

F300 971

**Cleaning**

Clean all parts carefully in Shellsol K or the like.

**Lubrication**

Before assembly, lubricate all parts with hydraulic oil.

**Inspection and Replacement**

Replace all seals and washers.

Check all parts carefully and make any replacements necessary.

Assembly

Assembling

Place the two flat neutral position springs in the slot.



F300 975

Place the curved springs between the flat ones and press them into place.

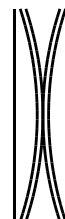

150-386.10

Line up the spring set.

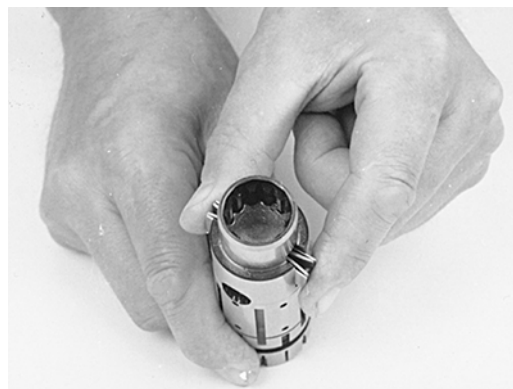

F300 976

Assembly

Guide the spool into the sleeve. Make sure that spool and sleeve for OSPB LS, OSPBX LS, OSPC LS, OSPC LSR and OSPF are placed correctly in relation to each other (see page 10).

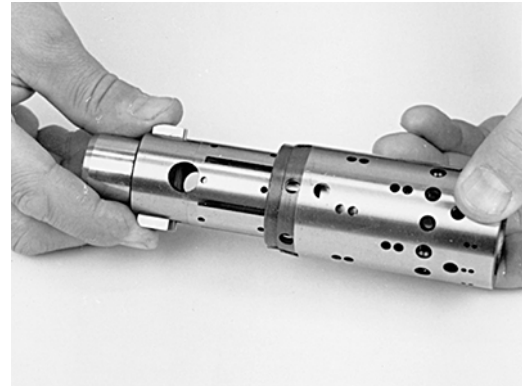

F300 977

**Assemble spool and sleeve**

**OSPB LS, OSPBX LS, OSPC LS, OSPC LSR and OSPF**

When assembling spool and sleeve only one of two possible ways of positioning the spring slots is correct. There are three slots in the spool and three holes in the sleeve in the end of the spool/sleeve opposite to the end with spring slots. Place the slots and holes opposite each other so that parts of the holes in the sleeve are visible through the slots in the spool.



F300 978

**OSPB CN and OSPC CN**

Assemble the spool/sleeve and make sure the marks on spool and sleeve are opposite each other [Dismantling](#) for more information.



F301 016

Assembly

Press the springs together and push the neutral position springs into place in the slave.

Line up the springs and centre them.

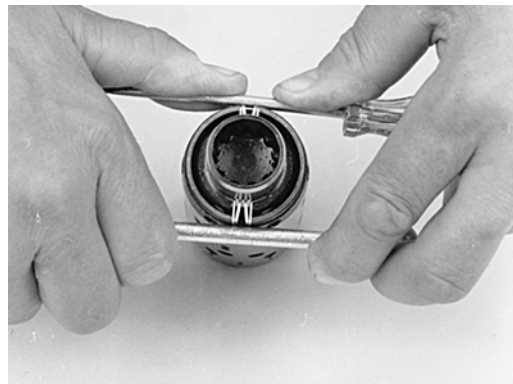

F300 980

Guide the ring down over the sleeve.

The ring should be able to move - free of springs.

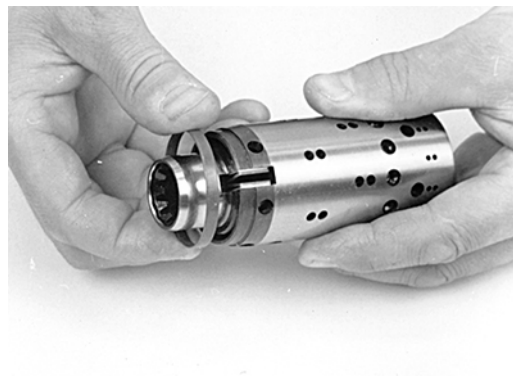

F300 981

Fit the cross pin into the spool/sleeve.

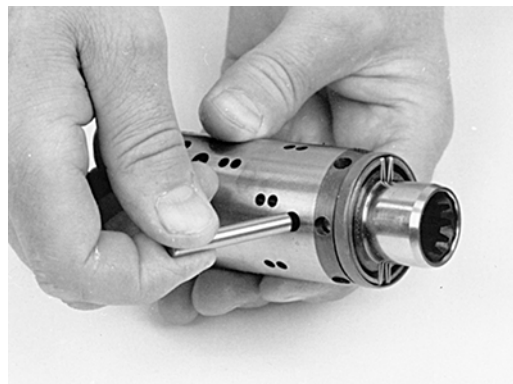

F300 982

Assembly

Fit bearing races and needle bearings as shown on the drawing next page.

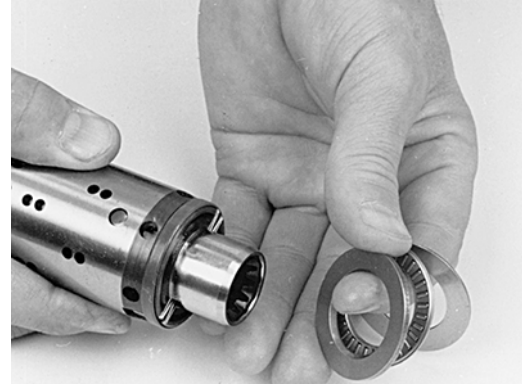

F300 983

Assembly Pattern for Bearings

**Assembling Pattern for Standard Bearing**

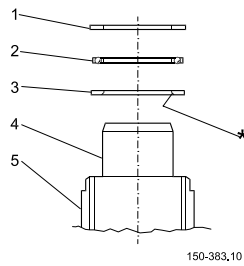

150-383,10

- 1. Outer bearing race
- 2. Needlebearing
- 3. Inner bearing race
- 4. Spool
- 5. Sleeve

**Assembly Pattern for Double Bearing**

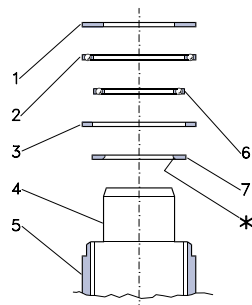

150-336.10

- 1. Washer for axial bearing
- 2. Outer needlebearing

Assembly

- 3. Outer bearing race
- 4. Spool
- 5. Sleeve
- 6. Inner needlebearing
- 7. Inner bearing race

The inside chamfer on the inner bearing race must face the inner spool.

Installation Instructions for O-ring / Kin-ring / Roto glyd

Turn the steering unit until the bore is horizontal. Guide the outer part of the assembly tool into the bore for the spool/sleeve.

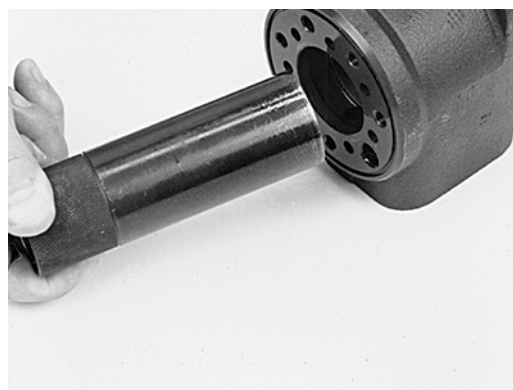

F300 984

Grease o-ring and king-ring/roto Glyd with hydraulic oil and place them on the tool.

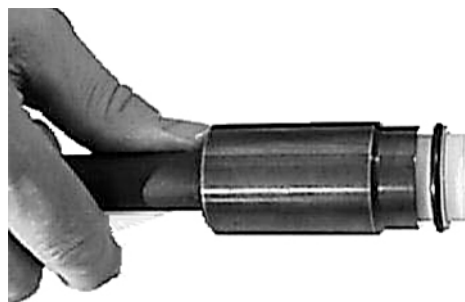

F300 985

Hold the outer part of the assembly tool in the bottom of the steering unit housing and guide the inner part of the tool right to the bottom.



F301 986

Assembly

Press and turn the o-ring/kin-ring into position in the housing.



F301 987

Draw the inner and outer parts of the assembly tool out of the steering unit bore, leaving the guide from the inner part in the bore.

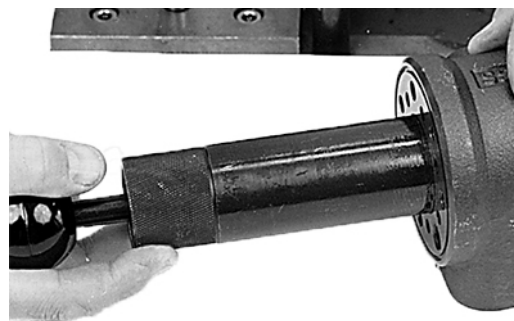

F301 988

Installation Instructions for Lip Seal

Lubricate the lip seal with hydraulic oil and place it on the assembly tool.



F300 989



Assembly

Guide the assembly tool right to the bottom.

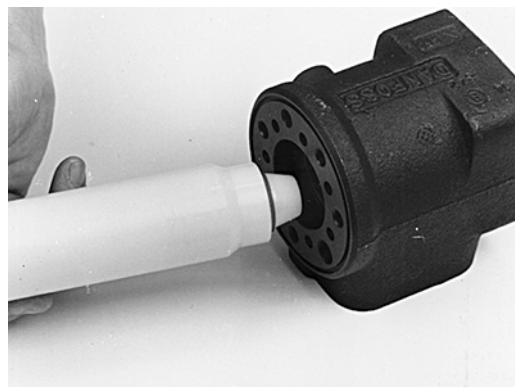

F300 990

Press and turn the lip seal into place in the housing.



F301 991

With a light turning movement, guide the spool and sleeve into the bore.

Fit the spool set holding the cross pin horizontal.

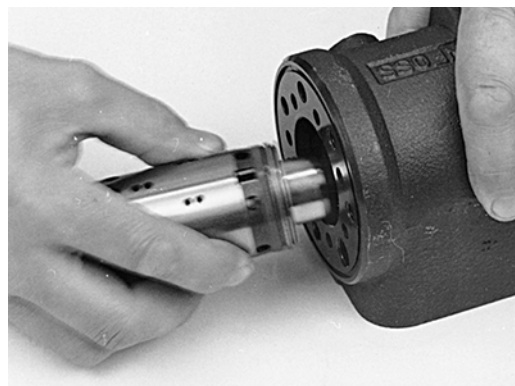

F300 992

Assembly

The spool set will push out the assembly tool guide. The o-ring and kin-ring/roto Glyd are now in position.



F300 993

Turn the steering unit until the bore is vertical again. Put the check valve ball into the hole indicated by the arrow.

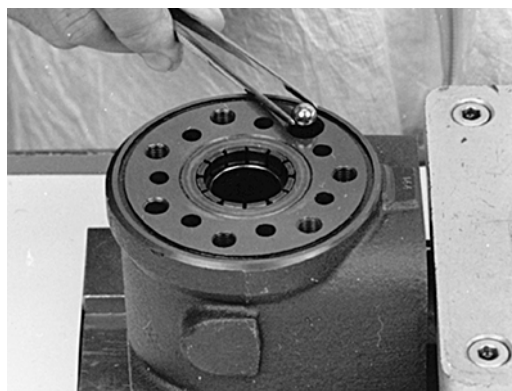

F300 944

Screw the threaded bush lightly into the check valve bore. The top of the bush must lie just below the surface of the housing.

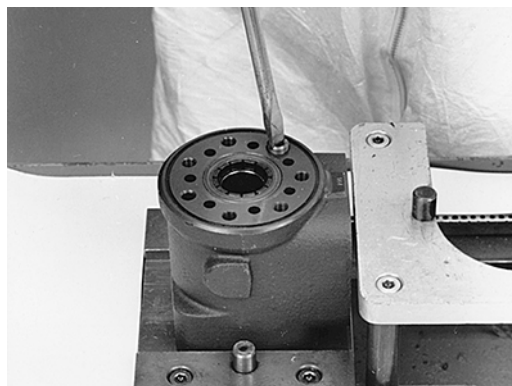

F300 953

Assembly

Place a ball in the two holes indicated by the arrows.

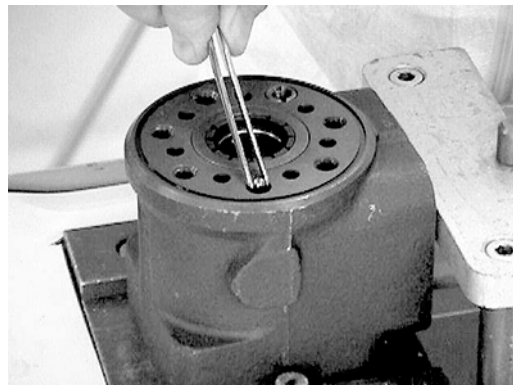

F300 995

Place a new pin in the same two holes.

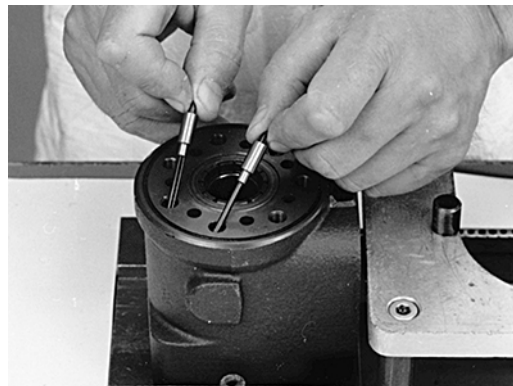

F300 996

In some cases a spring has to be fitted (see page 4 pos. 38) on the pin before it is placed in the housing.

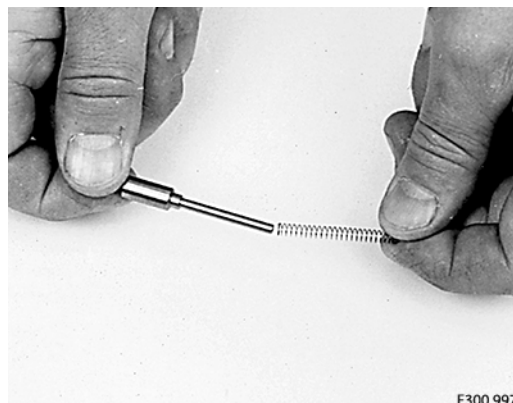

F300 997

Assembly

Grease the o-ring with mineral oil approx. viscosity 500 mm<sup>2</sup>/s [SUS] at 20°C [68 °F].

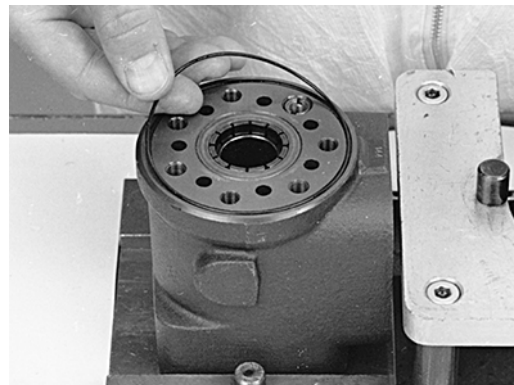

F300 998

Place the distributor plate so that the channel holes match the holes in the housing.

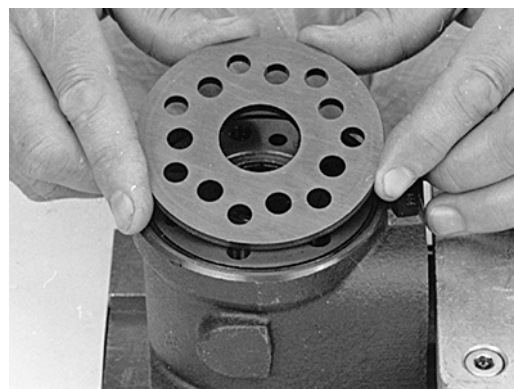

F300 999

Guide the cardan shaft down into the bore so that the slot is parallel with the connection flange.

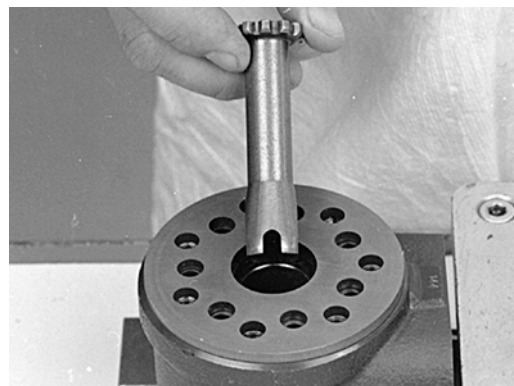

F301 000

Assembly

Place the cardan shaft as shown - so that it is held in position by the mounting fork.

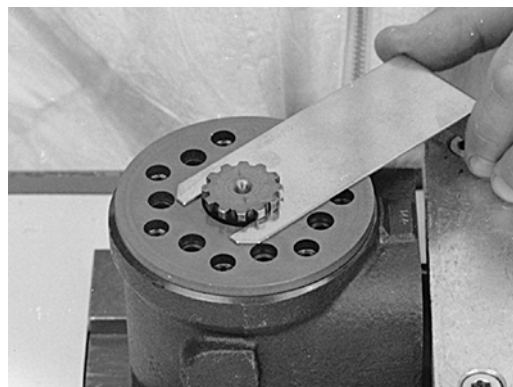

F301 001

Grease the two o-rings with mineral oil approx. viscosity 500 mm<sup>2</sup>/s [SUS] at 20°C [°F] and place them in the two grooves in the gear rim. Fit the gearwheel and rim on the cardan shaft.

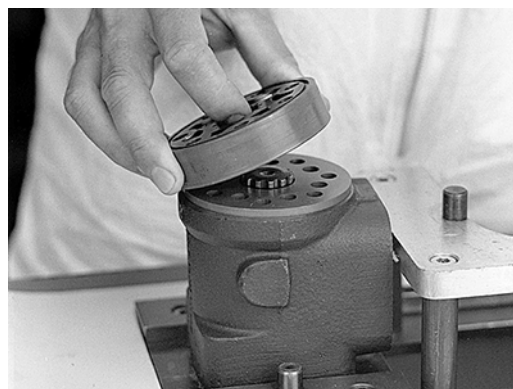

F300 949

**!** Caution

Fit the gearwheel (rotor) and cardan shaft so that a tooth base in the rotor is positioned in relation to the shaft slot as shown. Turn the gear rim so that the seven trough holes match the holes in the housing.

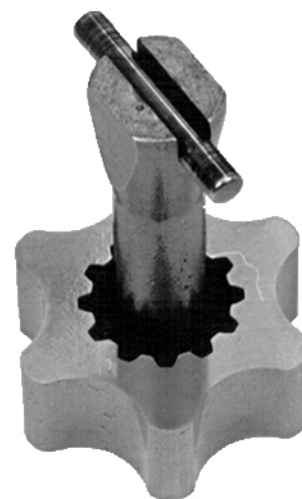

F301 002

Assembly

Fit the spacer, if any.

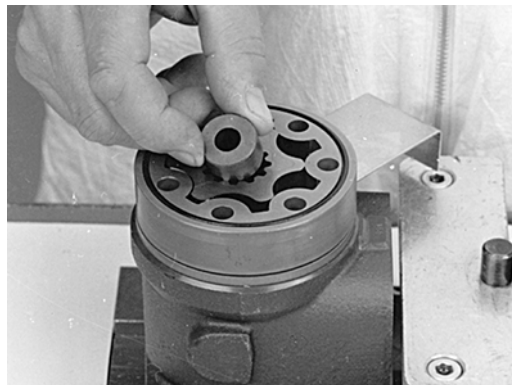

F301 003

Place the end cover in position.

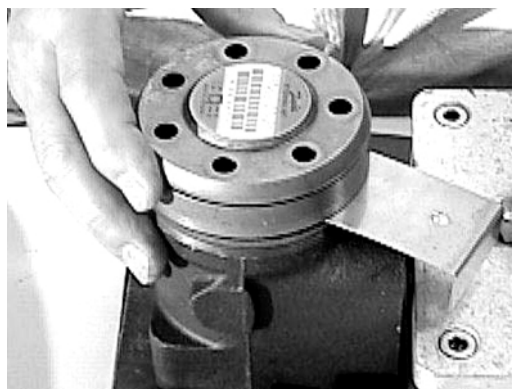

F301 004

Fit the special screw with washer and place it in the hole shown.

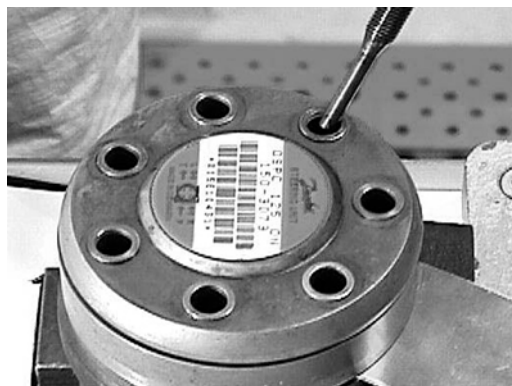

F301 005

Assembly

Fit the six screws with washers and insert them.

Cross-tighten all the screws and the rolled pin with a torque of  $30 \pm 6$  N.m [ $265.5 \pm 53$  lbf.in].

The OSPB, OSPB LS and OSPBX LS can now be function tested.

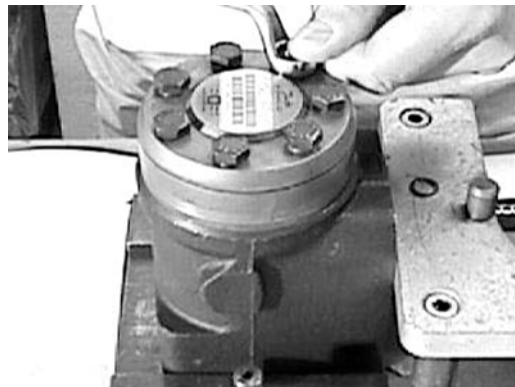

F300 947

Assembly of the Pressure Relief Valve for OSPC

Fit the piston.

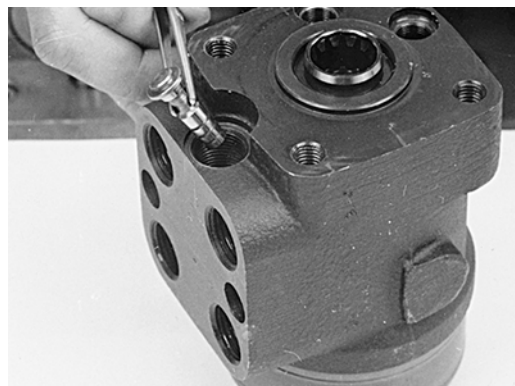

F300 938

Fit the spring

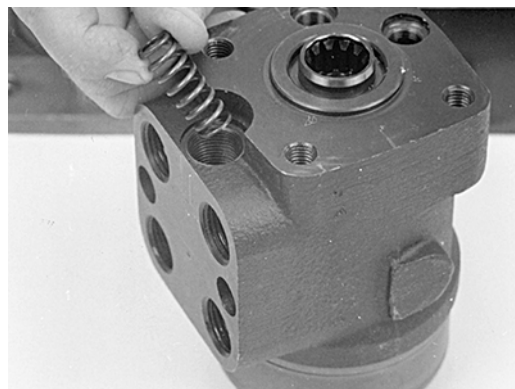

F301 013

Assembly

Screw in the setting screw with an 8 mm hexagon socket spanner.

Make the pressure setting on a panel or the vehicle.

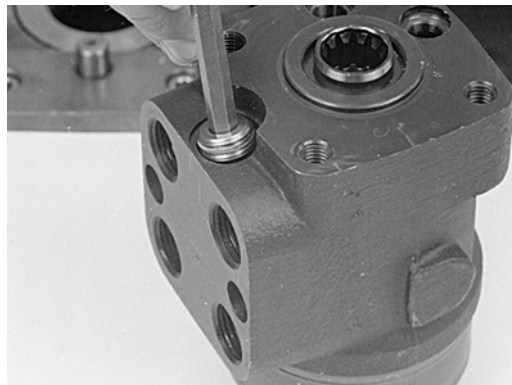

F300 968

Screw plug with dust seal into the housing using an 8 mm hexagon socket spanner.

Tightening torque: 65 +/- 5 N.m. [575.3 +/- 44.2 lbf.in]

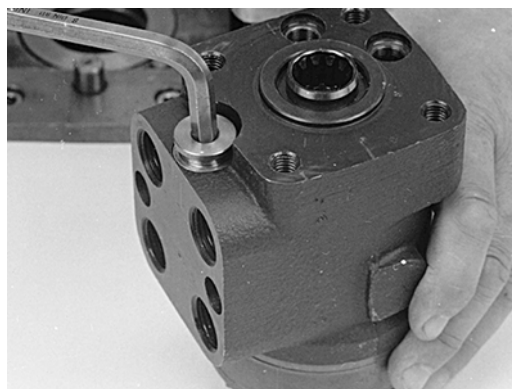

F300 941

Assembly of the Shock Valves for OSPC/OSPC LS/OSPC LSR

Put a ball in the two holes indicated by the arrows.

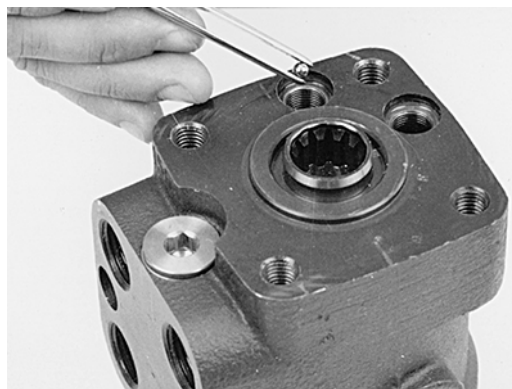

F301 006



Assembly

Place springs and valve cones over the two balls.

The blue spring applies to setting range 90-180 bar [1305-2610 psi]. The untreated spring applies to setting range 170-260 bar [2465-3770 psi]

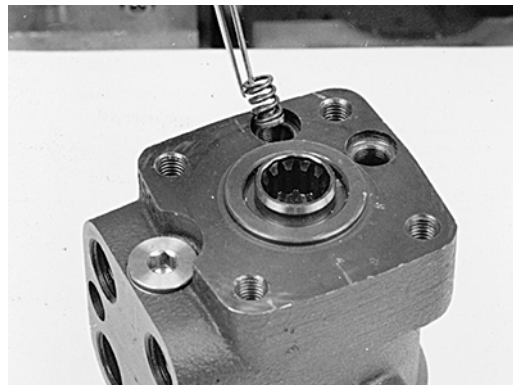

F301 007

Screw in the two setting screws using a 6 mm hexagon socket spanner. Make the pressure setting on a panel or the vehicle.

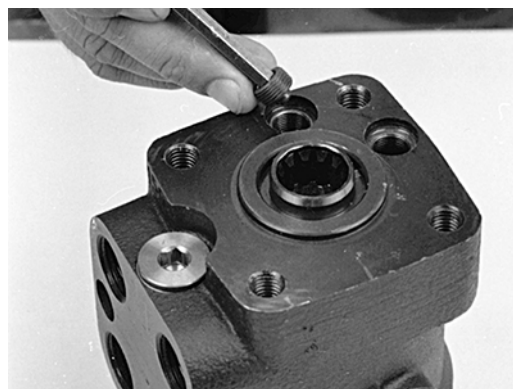

F301 008

Screw plug with seal ring into the two shock valves and tighten them with a torque of : 30 +10 N.m [265.5 + 88.5 lbf.in] using a 6 mm hexagon socket spanner.

Steering unit type OSPC, OSPC LS or OSPC LSR is now assembled.

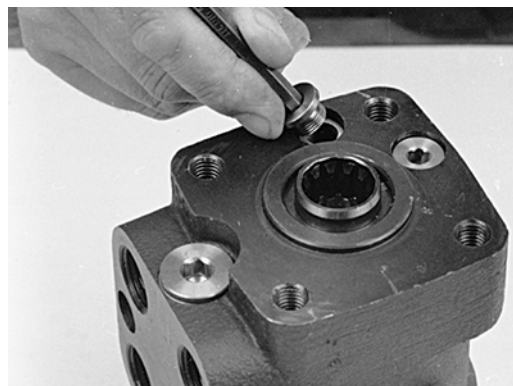

F301 009

Assembly

Place the dust seal ring in the housing. With the OSPC, OSPC LS and OSPC LSR the dust seal ring must be placed only after the pressure relief valve and shock valves have been fitted.

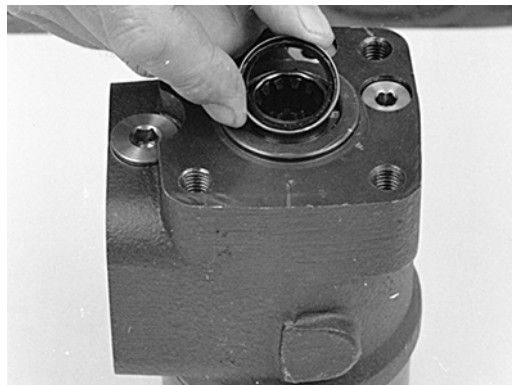

F301 010

Fit the dust seal ring in the housing using special tool SJ 150-9000-22 (see page 5) and a plastic hammer.

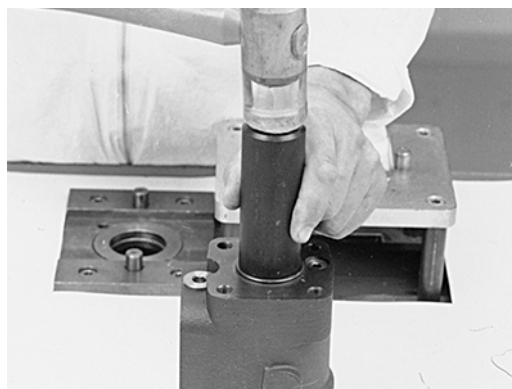

F301 011

Press the plastic plugs into the connection ports.  
Do not use a hammer!

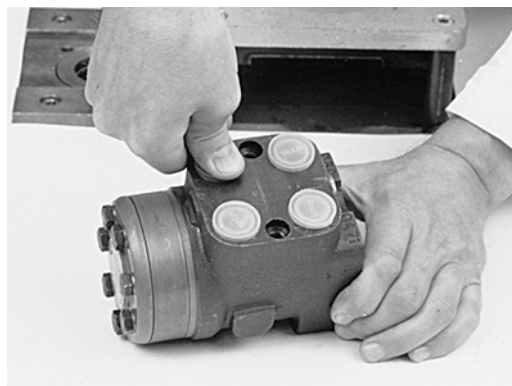

F301 012

Maximum Tightening Torque and Hydraulic Connections

Maximum Tightening Torque and Hydraulic Connections

*Maximum Tightening Torque and Hydraulic Connections*

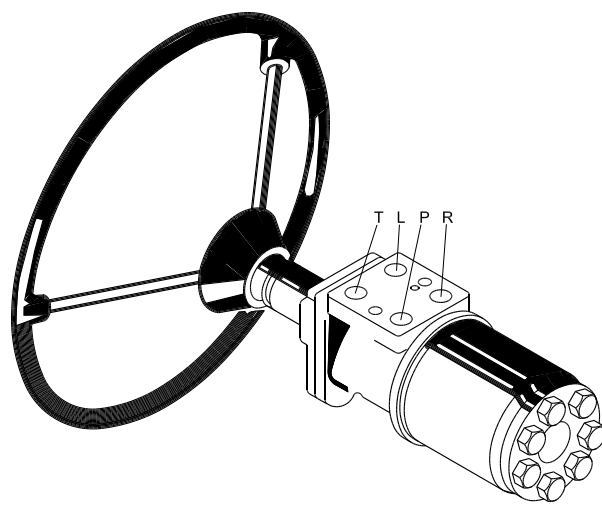

150-382.10

T: Tank

L: Left port

P: Pump

R: Right port

Screwed connection	Maximum tightening torque N.m [lbf.in]			
	With cutting edge	With cooper washer	With aluminium washer	With O-ring
G 1/4	35 [309]	35 [309]	35 [309]	-
G 3/8	70 [619]	45 [398]	50 [442]	-
G 1/2	100 [885]	55 [486]	80 [708]	-
7/16 -20 UNF	-	-	-	20 [177]
3/4 -16 UNF	-	-	-	60 [531]
M 12 • 1.5	30 [265]	20 [177]	30 [265]	25 [221]
M18 • 1.5	80 [708]	55 [486]	70 [619]	50 [442]
M22 • 1.5	100 [885]	65 [575]	80 [708]	60 [531]



**Products we offer:**

- Bent Axis Motors
- Closed Circuit Axial Piston Pumps and Motors
- Displays
- Electrohydraulic Power Steering
- Electrohydraulics
- Hydraulic Power Steering
- Integrated Systems
- Joysticks and Control Handles
- Microcontrollers and Software
- Open Circuit Axial Piston Pumps
- Orbital Motors
- PLUS+1® GUIDE
- Proportional Valves
- Sensors
- Steering
- Transit Mixer Drives

**Danfoss Power Solutions** is a global manufacturer and supplier of high-quality hydraulic and electronic components. We specialize in providing state-of-the-art technology and solutions that excel in the harsh operating conditions of the mobile off-highway market. Building on our extensive applications expertise, we work closely with our customers to ensure exceptional performance for a broad range of off-highway vehicles.

We help OEMs around the world speed up system development, reduce costs and bring vehicles to market faster.

Danfoss – Your Strongest Partner in Mobile Hydraulics.

**Go to [www.powersolutions.danfoss.com](http://www.powersolutions.danfoss.com) for further product information.**

Wherever off-highway vehicles are at work, so is Danfoss.

We offer expert worldwide support for our customers, ensuring the best possible solutions for outstanding performance. And with an extensive network of Global Service Partners, we also provide comprehensive global service for all of our components.

Please contact the Danfoss Power Solution representative nearest you.

**Comatrol**

[www.comatrol.com](http://www.comatrol.com)

**Schwarz Müller-Inverter**

[www.schwarzmueller-inverter.com](http://www.schwarzmueller-inverter.com)

**Turolla**

[www.turollaocg.com](http://www.turollaocg.com)

**Valmova**

[www.valmova.com](http://www.valmova.com)

**Hydro-Gear**

[www.hydro-gear.com](http://www.hydro-gear.com)

**Daikin-Sauer-Danfoss**

[www.daikin-sauer-danfoss.com](http://www.daikin-sauer-danfoss.com)

Local address:

**Danfoss Power Solutions US Company**  
2800 East 13th Street  
Ames, IA 50010, USA  
Phone: +1 515 239 6000

**Danfoss Power Solutions GmbH & Co. OHG**  
Krokamp 35  
D-24539 Neumünster, Germany  
Phone: +49 4321 871 0

**Danfoss Power Solutions ApS**  
Nordborgvej 81  
DK-6430 Nordborg, Denmark  
Phone: +45 7488 2222

**Danfoss Power Solutions (Shanghai) Co. Ltd.**  
Building #22, No. 1000 Jin Hai Rd  
Jin Qiao, Pudong New District  
Shanghai, China 201206  
Phone: +86 21 3418 5200

Danfoss can accept no responsibility for possible errors in catalogues, brochures and other printed material. Danfoss reserves the right to alter its products without notice. This also applies to products already on order provided that such alterations can be made without subsequential changes being necessary in specifications already agreed. All trademarks in this material are property of the respective companies. Danfoss and the Danfoss logotype are trademarks of Danfoss A/S. All rights reserved.