

TROUBLESHOOTING MANUAL

INDUSTRIAL ENGINES

ELECTRONIC CONTROL

3TNV82A	4TNV84
3TNV82A-B	4TNV84T
3TNV84	4TNV84T-Z
3TNV84T	4TNV88
3TNV84T-B	4TNV88-B
3TNV88	4TNV88-U
3TNV88-B	4TNV94L
3TNV88-U	4TNV98
	4TNV98-Z
	4TNV98-E
	4TNV98T
	4TNV98T-Z
	4TNV106
	4TNV106T

**California
Proposition 65 Warning**

Diesel engine exhaust and some of its constituents are known to the state of California to cause cancer, birth defects, and other reproductive harm.

**California
Proposition 65 Warning**

Battery posts, terminals, and related accessories contain lead and lead compounds, chemicals known to the state of California to cause cancer and reproductive harm.
Wash hands after handling.

Section 1

FAILURE DIAGNOSIS

	Page
DTCs (Diagnostic Trouble Codes) General Description.....	1-3
DTC Code List.....	1-3
Description Items.....	1-7
Analog Input Related Failures	1-8
Pulse Sensor Related Failures	1-60
Contact Output Related Failures	1-66
Contact Input Related Failures	1-100
Actuators etc.....	1-114
E-ECU Internal and Communication Errors.....	1-122
Method and Procedure of Failure Diagnosis	1-133
Description Items.....	1-133
Analog Input Related Failures	1-136
Pulse Sensor Related Failures	1-164
Contact Output Related Failures	1-170
Contact Input Related Failures	1-187
Actuator Related Failures	1-193
ECU Internal and Communication Errors	1-197
FAILURE INDICATOR LAMP FLASHING PATTERN	1-207
Using the Failure Indicator for Failure Diagnosis	1-208
Flashing Patterns of the Failure Indicator.....	1-208
Factor Analysis.....	1-210
2G-Type Eco-Governor Speed-Fluctuation Factor Analysis .	1-210
2G-Type Eco-Governor Engine	
Stalling/Start-Up Inability Factor Analysis.....	1-213
2G-Type Eco-Governor Black Smoke Factor Analysis.....	1-216

This Page Intentionally Left Blank

DTCS (DIAGNOSTIC TROUBLE CODES) GENERAL DESCRIPTION

DTC Code List

Classification	DTC	Lamp Flashing Patterns	Error Item		Referenced page number	
			Area	Status	Overview	Failure Diagnosis
Analog Input Related Failures	P1202/4	7	Rack position sensor	Error (low voltage)	P.1-8	P.1-136
	P1203/3			Error (high voltage)	P.1-10	
	P0122/4	5	Accelerator sensor	Error (low voltage)	P.1-12	P.1-140
	P1203/3			Error (high voltage)	P.1-14	
	P0124/2			Intermittent failure	P.1-16	
	P1125/1			Error (foot pedal-close position)	P.1-18	P.1-144
	P1126/0			Error (foot pedal-open position)	P.1-20	
	P0222/4	1-8	Spare accelerator sensor	Error (low voltage)	P.1-22	P.1-148
	P0223/3			Error (high voltage)	P.1-24	
	P0224/2			Intermittent failure	P.1-26	
	P1225/1			Error (foot pedal-close position)	P.1-28	P.1-144
	P1226/0			Error (foot pedal-open position)	P.1-30	
	P1227/8			Error (pulse communication)	P.1-32	
	P0222/4	1-9	Atmospheric pressure sensor	Error (low voltage)	P.1-34	P.1-148
	P0223/3			Error (high voltage)	P.1-36	
	P0224/2			Intermittent failure	P.1-38	
	P0668/4	4-1	ECU Temperature Sensor	Error (low voltage)	P.1-40	P.1-154
	P0669/3			Error (high voltage)	P.1-41	
	P1644/2			Intermittent failure	P.1-42	
	P0634/0	2-5	ECU Temperature Rise Alarm		P.1-43	P.1-154
	P0117/4	4	Cooling water temperature sensor	Error (Low Voltage)	P.1-45	P.1-156
	P0118/3			Error (High Voltage)	P.1-47	
	P0119/2			Intermittent failure	P.1-49	
	P0217/0	3-6	Cooling Water Temperature Rise Alarm		P.1-51	P.1-156
	P0642/4	2-4	SENSOR 5V	Error (low voltage)	P.1-53	P.1-160
	P0643/3			Error (High Voltage)	P.1-54	
P1644/2	Intermittent failure			P.1-55		
P0562/1	2-3	Power supply Voltage	Error (Low Voltage)	P.1-56	P.1-56	
P0563/0			Error (High Voltage)	P.1-58	P.1-58	

Classification	DTC	Lamp Flashing Patterns	Error Item		Referenced page number	
			Area	Status	Overview	Failure Diagnosis
Pulse Sensors	P0340/4	6	Speed Sensor	Error	P.1-60	P.1-164
	P1340/4	1-1	Spare speed sensor	Error	P.1-62	P.1-167
	P0219/0	9	Overspeed Error		P.1-64	P.1-64
Contact Output Related Failures	P1222/4	1-7	Rack actuator Relay	Error A	P.1-66	P.1-170
	P1223/3			Error B	P.1-68	
	P1224/2			Intermittent failure	P.1-70	
	P1232/4	1-5	Start Assist Relay	Error A	P.1-72	P.1-174
	P1233/3			Error B	P.1-74	
	P1234/2			Intermittent failure	P.1-76	
	P1242/4	1-4	CSD solenoid valve	Error A	P.1-78	P.1-178
	P1243/3			Error B	P.1-80	
	P1244/2			Intermittent failure	P.1-82	
	P1402/4	1-3	EGR valve	Error A (Step Motor A-Phase)	P.1-84	P.1-182
	P1403/3			Error B (Step Motor A-Phase)	P.1-86	
	P1412/4			Error A (Step Motor B-Phase)	P.1-88	
	P1413/3			Error B (Step Motor B-Phase)	P.1-90	
	P1422/4			Error A (Step Motor C-Phase)	P.1-92	
	P1423/3			Error B (Step Motor C-Phase)	P.1-94	
	P1432/4			Error A (Step Motor D-Phase)	P.1-96	
	P1433/3			Error B (Step Motor D-Phase)	P.1-98	
	Contact Input Related Failures	P1192/4	2-1	Oil pressure switch	Error	P.1-100
P1198/1		3-1	Oil Pressure Descend Error		P.1-102	
P1562/4		2-2	Charge switch	Error	P.1-104	
P1568/1		3-2	Charge Alarm		P.1-106	
P1217/0		3-3	Abnormal Water Temperature		P.1-108	
P1101/0		3-4	Air cleaner Clogging Alarm		P.1-110	
P1151/0		3-5	Oil-water separator Alarm		P.1-112	

Classification	DTC	Lamp Flashing Patterns	Error Item		Referenced page number		
			Area	Status	Overview	Failure Diagnosis	
Actuator Errors	P1212/4	8	Rack actuator	Error (low current)	P.1-114	P.1-193	
	P1213/3			Error (high current)	P.1-116		
	P1211/7			Mechanical failure	P.1-118		
	P1214/2		Engine	Error	P.1-120		
ECU inside and Communication Related Failures	P0605/12	4-1	ECU Internal	Flash ROM	Error (Checksum A)	P.1-122	P.1-197
	P1605/2				Error (Checksum B)		
	P1606/2				Error (Checksum C)		
	P1620/12			Map format	Error		
	P1601/2			EEPROM	Error (Checksum)		
	P0601/12				Error (read/write error)		
	P1610/12			Sub CPU	Error A	P.1-123	
	P1611/12				Error B		
	P1612/12				Error C		
	P0686/4	1-6	Main relay	Error	P.1-124	P.1-199	
	U0001/12	1-2	CAN Communication	Error	P.1-126	P.1-203	
	U0167/12	4-2	Immobilizer	Error (CAN communication)	P.1-128	P.1-205	
	U1167/8			Error (pulse communication)	P.1-130		
U0426/2	Error (System)			P.1-132			

This Page Intentionally Left Blank

Description Items

DTC	Code Number	DTC Name
-----	-------------	----------

DTC Detecting Conditions

1 - Precondition; 2 - Detecting condition(s); 3 - Flashing pattern of failure indicator	Check points
1. Precondition for Error detection 2. Error detecting Condition 3. Indicates the pattern in which the failure lamp flashes when the DTC is output. (For detailed information on various flashing patterns, see Annex).	This column shows what parts or items should be checked to identify the cause of the error. For details, see "<Diagnosis Description>."

Movement at Error occurrence

Error Mode	[Operation Continuation] / [Run Under Restrictions] / [Stop Immediately]: The engine operation after detecting the error is described. * [Operation Continuation]:After detecting the error, the system lets the engine continue to run without any restrictions. [Run Under Restrictions]:The system lets the engine continue to run but restricts the High idle speed, engine power, and/or other performance factors as appropriate. [Stop Immediately]: The system stops the engine immediately after detecting the error.When any error is detected before starting the engine, the starter will not rotate.
Run restricted?	Yes/No.: If Yes, this field details how the engine run is restricted when the error has occurred.
Recovery Conditions	Yes/No.: If Yes, this field describes what conditions must be true for the error mode to be reset.
Remarks	This field describes some notes on safety precautions and so on, as appropriate.

Estimation of Failure cause/Error condition

Provides descriptive information on possible points of failure, possible direct causes (such as a disconnected sensor wire), or possible system abnormalities that has indirectly caused the failure (such as abnormally high cooling water temperature), as can be estimated from the output DTC.

Note: Indicates failures that might be related with the output DTC.

Diagnosis Description

Describes methods or procedures of failure diagnosis.

* After successful recovery by the replacement of ECU, sensor or actuator, make sure that installing the previous parts will reproduce the same error.

Analog Input Related Failures

Rack position sensor

(1) P1202/4: Failure with Rack Position Sensor (Low Voltage)

DTC	P1202/4	Rack Position Sensor Error (Low Voltage)
-----	---------	--

DTC Detecting Conditions

1 - Precondition; 2 - Detecting condition(s); 3 - Flashing pattern of failure indicator	Check points
1. Key switch ON. 2. The sensor voltage lower limit and below [at E-ECU activation, engine running] 3. Seven flashes.	Connector Harness Rack position sensor E-ECU

Movement at Error occurrence

Error Mode	[Run Under Restrictions]: The engine continues to run in on-error engine control mode. If any error is detected at E-ECU activation, it takes 1 - 10 seconds from the starter begins to rotate until the engine starts.
Run restricted?	Yes: • The High idle speed is restricted to one of the following, whichever smaller: • 80% of the pre-error High idle speed • 150% of the Low idle speed • The fuel injection rate is restricted.
Recovery Conditions	No.
Remarks	The High and Low idle speeds must be equal to those specified in the engine specifications.

Estimation of Failure cause/Error condition

- The connector may not be properly connected.
 - Wiring defect of the harness
 - The rack position sensor's signal wires may be disconnected or short-circuited with GND.
 - The SENSOR 12V wire may be disconnected or short-circuited with GND (*NOTE).
 - The SENSOR GND wire may be short-circuited with POWER SUPPLY (*NOTE).
- *NOTE) If the SENSOR 12V wire is short-circuited with GND or SENSOR GND wire is short-circuited with POWER SUPPLY, the E-ECU's power supply line fuse 10A might be blown. With this fuse blown, the E-ECU may fail to detect/indicate the error, and to store the error history.**

The rack position sensor may be faulty.

- Output defect of the rack position signal by a disconnection or a short circuit of the inner wiring
- The E-ECU internal circuitry may be faulty.

Diagnosis Description

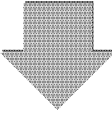
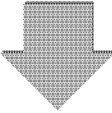
1) Initial diagnosis with the diagnosis tool	<ul style="list-style-type: none">• Check the fault indication.• Check the sensor voltage (AD value). <p>*For details of the method and the procedure of diagnosis, see P.1-136</p> 
2) Check of connectors/wiring	<ul style="list-style-type: none">• Before beginning your work, be sure to turn off the key switch.• Check that the connector of the rack actuator is correctly inserted.• Check that the wiring of the rack actuator is not disconnected or the insulation of the wiring is not peeled. 
3) Failure Diagnostic Work	<ul style="list-style-type: none">• Check the input voltage of the rack position sensor (voltage of the sensor 12V line).• Check the harness for correct continuity. <p>*For details of the method and the procedure of diagnosis, see P.1-136</p>

(2) P1203/3: Failure with Rack Position Sensor (High Voltage)

DTC	P1202/3	Failure with Rack Position Sensor (High Voltage)
------------	----------------	---

DTC Detecting Conditions

1 - Precondition; 2 - Detecting condition(s); 3 - Flashing pattern of failure indicator	Check points
1. Key switch ON. 2. The sensor voltage upper limit and above [at E-ECU activation, engine running] 3. Seven flashes.	Connector Harness rack position sensor Rack actuator E-ECU

Movement at Error occurrence

	Detection at the engine start	Detection at the engine running
Error Mode	[Run Under Restrictions]: Start the engine in on-error engine control mode. It takes 1 to 10 seconds from the starter's rotation to the engine start.	[Stop Immediately]: The engine stops running.
Run restricted?	Yes: • The High idle is restricted to one of the following, whichever smaller: • 80% of the pre-error High idle speed • 150% of the Low idle speed • The fuel injection rate is restricted.	Yes: The rack actuator relay is turned OFF, and the rack position is forcibly set to the engine stop position.
Recovery Conditions	No.	No.
Remarks	The High and Low idle speeds must be equal to those specified in the engine specifications.	

Estimation of Failure cause/Error condition

- The connector may not be properly connected.
- Wiring defect of the harness
 - The SENSOR GND wire may be disconnected.
 - The rack position sensor signal wire may be short-circuited with POWER SUPPLY.
 - The rack actuator wiring may be short-circuited with GND (with engine running).
- The rack position sensor may be faulty.
 - Output defect of the rack position signal by a disconnection or a short circuit of the inner wiring
- The rack actuator may be faulty.
 - The rack actuator inner wiring may be short-circuited with GND (with engine running).
- The E-ECU internal circuitry may be faulty.

Diagnosis Description

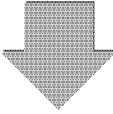
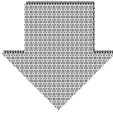
1) Initial diagnosis with the diagnosis tool	<ul style="list-style-type: none">• Check the fault indication.• Check the sensor voltage (AD value). <p>*For details of the method and the procedure of diagnosis, see P.1-136</p>
	
2) Check of connectors/wiring	<ul style="list-style-type: none">• Before beginning your work, be sure to turn off the key switch.• Check that the connector of the rack actuator is correctly inserted.• Check that the wiring of the rack actuator is not disconnected or the insulation of the wiring is not peeled.
	
3) Failure Diagnostic Work	<ul style="list-style-type: none">• Check the input voltage of the rack position sensor (voltage of the sensor 12V line).• Check the harness for correct continuity. <p>*For details of the method and the procedure of diagnosis, see P.1-136</p>

Accelerator sensor

(1) P0122/4: Accelerator Sensor Error (Low Voltage)

DTC	P0122/4	Accelerator Sensor Error (Low Voltage)
-----	---------	--

DTC Detecting Conditions

1 - Precondition; 2 - Detecting condition(s); 3 - Flashing pattern of failure indicator	Check points
1. Key switch ON. 2. Sensor voltage 0.2 [V] or lower. 3. Five flashes.	Harness Accelerator sensor

Movement at Error occurrence

	Spare Accelerator Sensor Function	
	Unavailable	Available
Error Mode	[Run Under Restrictions]: The engine runs at a constant rotational speed.	[Stop Immediately]: The engine continues to run using the spare accelerator sensor instead.
Run restricted?	Yes: The target speed is set to the "on-error target speed (standard value: 1500[min^{-1}])" or "pre-error target speed".	No.
Recovery Conditions	Yes: This error will be automatically reset when a normal voltage (0.2 to 4.6[V]) is input.	Yes: This error will be automatically reset when a normal voltage (0.2 to 4.6[V]) is input.
Remarks		

Estimation of Failure cause/Error condition

- The connector may not be properly connected.
- Wiring defect of the harness
 - The accelerator sensor's signal wires may be disconnected or short-circuited with GND.
 - The SENSOR 5V wire may be disconnected or short-circuited with GND.
 - The SENSOR GND wire may be short-circuited with POWER SUPPLY (*NOTE).
- ***NOTE) If the SENSOR GND wire is short-circuited with POWER SUPPLY, the E-ECU's power supply line fuse 10A might be blown. With this fuse blown, the E-ECU may fail to detect/indicate the error, and to store the error history.**
- The accelerator sensor may be faulty.
 - Sensor output defect by a disconnection of the accelerator sensor inner wiring or a sliding resistance increase
- The E-ECU internal circuitry may be faulty.

Diagnosis Description

1) Initial diagnosis with the diagnosis tool	<ul style="list-style-type: none">• Check the fault indication.• Check the sensor voltage. <p>*For details of the method and the procedure of diagnosis, see P.1-140</p>
--	---

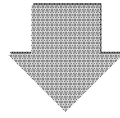

2) Check of connectors/wiring	<ul style="list-style-type: none">• Before beginning your work, be sure to turn off the key switch.• Check that the connector of the accelerator sensor is correctly inserted.• Check that the wiring of the accelerator sensor is not disconnected or the insulation of the wiring is not peeled.
-------------------------------	--

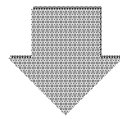

3) Failure Diagnostic Work	<ul style="list-style-type: none">• Check the resistance value of the accelerator sensor.• Check the harness for correct continuity.• Check the output voltage of the accelerator sensor. <p>*For details of the method and the procedure of diagnosis, see P.1-140</p>
----------------------------	---

(2) P0123/3: Accelerator Sensor Error (High Voltage)

DTC	P0123/3	Accelerator Sensor Error (High Voltage)
------------	----------------	--

DTC Detecting Conditions

1 - Precondition; 2 - Detecting condition(s); 3 - Flashing pattern of failure indicator	Check points
1. Key switch ON. 2. Sensor voltage 4.6 [V] or higher. 3. Five flashes.	Harness Accelerator sensor

Movement at Error occurrence

	Spare Accelerator Sensor Function	
	Unavailable	Available
Error Mode	[Run Under Restrictions]: The engine runs at a constant rotational speed.	[Stop Immediately]: The engine continues to run using the spare accelerator sensor instead.
Run restricted?	Yes: The target speed is set to the "on-error target speed (standard value: 1500[min^{-1}])" or "pre-error target speed".	No.
Recovery Conditions	Yes: This error will be automatically reset when a normal voltage (0.2 to 4.6[V]) is input.	Yes: This error will be automatically reset when a normal voltage (0.2 to 4.6[V]) is input.
Remarks		

Estimation of Failure cause/Error condition

- The connector may not be properly connected.
- Wiring defect of the harness
 - The SENSOR GND wire may be disconnected.
 - The sensor signal wire may be short-circuited with POWER SUPPLY.
- The accelerator sensor may be faulty.
 - Sensor output defect by a short circuit with power supply of the accelerator sensor inner wiring
- The E-ECU internal circuitry may be faulty.

Diagnosis Description

1) Initial diagnosis with the diagnosis tool	<ul style="list-style-type: none">• Check the fault indication.• Check the sensor voltage. <p>*For details of the method and the procedure of diagnosis, see P.1-140</p>
--	---

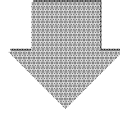

2) Check of connectors/wiring	<ul style="list-style-type: none">• Before beginning your work, be sure to turn off the key switch.• Check that the connector of the accelerator sensor is correctly inserted.• Check that the wiring of the accelerator sensor is not disconnected or the insulation of the wiring is not peeled.
-------------------------------	--

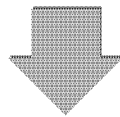

3) Failure Diagnostic Work	<ul style="list-style-type: none">• Check the resistance value of the accelerator sensor.• Check the harness for correct continuity.• Check the output voltage of the accelerator sensor. <p>*For details of the method and the procedure of diagnosis, see P.1-140</p>
----------------------------	---

(3) P0124/2: Intermittent Failure with Accelerator Sensor

DTC	P0124/2	Intermittent Failure with Accelerator Sensor
------------	----------------	---

DTC Detecting Conditions

1 - Precondition; 2 - Detecting condition(s); 3 - Flashing pattern of failure indicator	Check points
1. Engine running. 2. Unconfirmed error detected 10 times. 3: Does not flash.	Connector Harness Accelerator sensor

Movement at Error occurrence

Error Mode	[Run Under Restrictions]: After detecting the error, the system lets the engine continue to run without any restrictions.
Run restricted?	No.
Recovery Conditions	No.
Remarks	

Estimation of Failure cause/Error condition

- The connector may not be properly connected.
- Wiring defect of the harness
 - Accelerator sensor signal wire may be disconnected, or short-circuited with GND or power supply.
 - Sensor 5V wire may be disconnected, or short-circuited with GND or power supply.
 - Sensor GND wire may be disconnected.
- The accelerator sensor may be faulty.
 - Inner wiring may be disconnected or short-circuited

Diagnosis Description

1) Initial diagnosis with the diagnosis tool	<ul style="list-style-type: none">• Check the fault indication.• Check the sensor voltage. <p>*For details of the method and the procedure of diagnosis, see P.1-140</p>
--	---

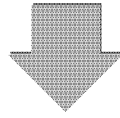

2) Check of connectors/wiring	<ul style="list-style-type: none">• Before beginning your work, be sure to turn off the key switch.• Check that the connector of the accelerator sensor is correctly inserted.• Check that the wiring of the accelerator sensor is not disconnected or the insulation of the wiring is not peeled.
-------------------------------	--

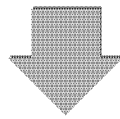

3) Failure Diagnostic Work	<ul style="list-style-type: none">• Check the resistance value of the accelerator sensor.• Check the harness for correct continuity.• Check the output voltage of the accelerator sensor. <p>*For details of the method and the procedure of diagnosis, see P.1-140</p>
----------------------------	---

(4) P0123/1: Accelerator Sensor Error (foot pedal-close position)

DTC	P1125/1	Accelerator Sensor Error (foot pedal-close position)
------------	----------------	---

DTC Detecting Conditions

1 - Precondition; 2 - Detecting condition(s); 3 - Flashing pattern of failure indicator	Check points
1. Key switch ON. 2. With sensor voltage at or below 0.65[V], foot pedal Normally Open switch detected being ON or foot pedal Normally Closed Switch detected being OFF. 3. Five flashes.	Harness Foot pedal

Movement at Error occurrence

Error Mode	[Run Under Restrictions]: The engine runs at a constant rotational speed.
Run restricted?	Yes: The target speed is set to the "on-error target speed (standard value: 1500[min^{-1}])" or "pre-error target speed".
Recovery Conditions	No.
Remarks	

Estimation of Failure cause/Error condition

- The connector may not be properly connected.
- Wiring defect of the harness
 - The wiring for the foot pedal Normally Closed switch may be disconnected.
 - The wiring for the foot pedal Normally Open switch may be short-circuited with GND.
- The foot pedal may be faulty.
 - The foot pedal inner wiring may be disconnected or short-circuited with GND.
- The E-ECU internal circuitry may be faulty.

Diagnosis Description

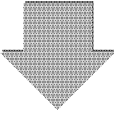
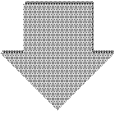
1) Initial diagnosis with the diagnosis tool	<ul style="list-style-type: none">• Check the fault indication.• Check that the foot pedal movement is correctly recognized. <p>*For details of the method and the procedure of diagnosis, see P.1-144</p>
	
2) Check of connectors/wiring	<ul style="list-style-type: none">• Before beginning your work, be sure to turn off the key switch.• Check that the connector of the foot pedal is correctly inserted.• Check that the wiring of the foot pedal is not disconnected or the insulation of the wiring is not peeled.
	
3) Failure Diagnostic Work	<ul style="list-style-type: none">• Check the foot pedal for correct continuity.• Check the harness for correct continuity. <p>*For details of the method and the procedure of diagnosis, see P.1-144</p>

(5) P1126/0: Accelerator Sensor Error (foot pedal-open position)

DTC	P1126/0	Accelerator Sensor Error (foot pedal-open position)
------------	----------------	--

DTC Detecting Conditions

1 - Precondition; 2 - Detecting condition(s); 3 - Flashing pattern of failure indicator	Check points
1. Key switch ON. 2. With sensor voltage 1.1[V] and above, foot pedal Normally Open switch detected being OFF or foot pedal Normally Closed Switch detected being ON. 3. Five flashes.	Harness Foot pedal

Movement at Error occurrence

Error Mode	[Run Under Restrictions]: The engine runs at a constant rotational speed.
Run restricted?	Yes: The target speed is set to the "on-error target speed (standard value: 1500[min^{-1}])" or "pre-error target speed".
Recovery Conditions	No.
Remarks	

Estimation of Failure cause/Error condition

- The connector may not be properly connected.
- Wiring defect of the harness
 - The wiring for the foot pedal Normally Open switch may be disconnected.
 - The wiring for the foot pedal Normally Closed switch may be short-circuited with GND.
- The foot pedal may be faulty.
 - The inner wiring may be disconnected or short-circuited with GND.
- The E-ECU internal circuitry may be faulty.

Diagnosis Description

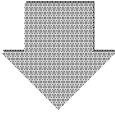
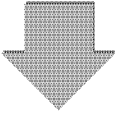
1) Initial diagnosis with the diagnosis tool	<ul style="list-style-type: none">• Check the fault indication.• Check that the foot pedal movement is correctly recognized. <p>*For details of the method and the procedure of diagnosis, see P.1-144</p>
	
2) Check of connectors/wiring	<ul style="list-style-type: none">• Before beginning your work, be sure to turn off the key switch.• Check that the connector of the foot pedal is correctly inserted.• Check that the wiring of the foot pedal is not disconnected or the insulation of the wiring is not peeled.
	
3) Failure Diagnostic Work	<ul style="list-style-type: none">• Check the foot pedal for correct continuity.• Check the harness for correct continuity. <p>*For details of the method and the procedure of diagnosis, see P.1-144</p>

Spare accelerator sensor (option)

(1) P0222/4: Failure with Spare Accelerator Sensor (Low Voltage)

DTC	P0222/4	Failure with Spare Accelerator Sensor (Low Voltage)
-----	---------	---

DTC Detecting Conditions

1 - Precondition; 2 - Detecting condition(s); 3 - Flashing pattern of failure indicator	Check points
1. Key switch ON. 2. Sensor voltage 0.2 [V] or lower. 3. One flash followed by eight flashes	Harness Spare accelerator sensor

Movement at Error occurrence

	Error detection of main accelerator sensor	
	Unavailable	Available
Error Mode	[Run As Is]: The engine continues to run using the main accelerator sensor.	[Run Under Restrictions]: The engine runs at a constant rotational speed.
Run restricted?	No.	Yes: The target speed is set to the "on-error target speed (standard value: 1500[min^{-1}])" or "pre-error target speed".
Recovery Conditions	Yes: This error will be automatically reset when a normal voltage (0.2 to 4.6[V]) is input.	Yes: This error will be automatically reset when a normal voltage (0.2 to 4.6[V]) is input.
Remarks		

Estimation of Failure cause/Error condition

- The connector may not be properly connected.
- Wiring defect of the harness
 - The spare accelerator sensor's signal wires may be disconnected or short-circuited with GND.
 - The SENSOR 5V wire may be disconnected or short-circuited with GND.
 - The SENSOR GND wire may be short-circuited with POWER SUPPLY (*NOTE).
- ***NOTE) If the SENSOR GND wire is short-circuited with POWER SUPPLY, the E-ECU's power supply line fuse 10A might be blown. With this fuse blown, the E-ECU may fail to detect/indicate the error, and to store the error history.**
- The spare accelerator sensor may be faulty.
 - Sensor output defect by a disconnection of the spare accelerator sensor inner wiring or a sliding resistance increase
- The E-ECU internal circuitry may be faulty.

Diagnosis Description

1) Initial diagnosis with the diagnosis tool	<ul style="list-style-type: none"> • Check the fault indication. • Check the sensor voltage. <p>*For details of the method and the procedure of diagnosis, see P.1-148</p>
--	--

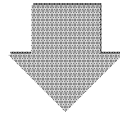

2) Check of connectors/wiring	<ul style="list-style-type: none"> • Before beginning your work, be sure to turn off the key switch. • Check that the connector of the spare accelerator sensor is correctly inserted. • Check that the wiring of the spare accelerator sensor is not disconnected or the insulation of the wiring is not peeled.
-------------------------------	--

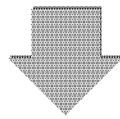

3) Failure Diagnostic Work	<ul style="list-style-type: none"> • Check the resistance value of the spare accelerator sensor. • Check the harness for correct continuity. • Check the output voltage of the spare accelerator sensor. <p>*For details of the method and the procedure of diagnosis, see P.1-148</p>
----------------------------	---

(2) P0223/3: Spare Accelerator Sensor Error (High Voltage)

DTC	P0223/3	Spare Accelerator Sensor Error (High Voltage)
------------	----------------	--

DTC Detecting Conditions

1 - Precondition; 2 - Detecting condition(s); 3 - Flashing pattern of failure indicator	Check points
1. Key switch ON. 2. Sensor voltage 4.6 [V] or higher. 3. One flash followed by eight flashes	Harness Spare accelerator sensor

Movement at Error occurrence

	Error detection of main accelerator sensor	
	Unavailable	Available
Error Mode	[Run As Is]: The engine continues to run using the main accelerator sensor.	[Run Under Restrictions]: The engine runs at a constant rotational speed.
Run restricted?	No.	Yes: The target speed is set to the "on-error target speed (standard value: 1500[min^{-1}])" or "pre-error target speed".
Recovery Conditions	Yes: This error will be automatically reset when a normal voltage (0.2 to 4.6[V]) is input.	Yes: This error will be automatically reset when a normal voltage (0.2 to 4.6[V]) is input.
Remarks		

Estimation of Failure cause/Error condition

- The connector may not be properly connected.
- Wiring defect of the harness
 - The SENSOR GND wire may be disconnected.
 - The sensor signal wire may be short-circuited with POWER SUPPLY.
- The spare accelerator sensor may be faulty.
 - Sensor output defect by a short circuit with power supply of the spare accelerator sensor inner wiring
- The E-ECU internal circuitry may be faulty.

Diagnosis Description

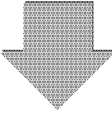
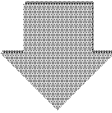
1) Initial diagnosis with the diagnosis tool	<ul style="list-style-type: none">• Check the fault indication.• Check the sensor voltage. <p>*For details of the method and the procedure of diagnosis, see P.1-148</p>
	
2) Check of connectors/wiring	<ul style="list-style-type: none">• Before beginning your work, be sure to turn off the key switch.• Check that the connector of the spare accelerator sensor is correctly inserted.• Check that the wiring of the spare accelerator sensor is not disconnected or the insulation of the wiring is not peeled.
	
3) Failure Diagnostic Work	<ul style="list-style-type: none">• Check the resistance value of the spare accelerator sensor.• Check the harness for correct continuity.• Check the output voltage of the spare accelerator sensor. <p>*For details of the method and the procedure of diagnosis, see P.1-148</p>

(3) P0224/2: Intermittent Failure with Spare Accelerator Sensor

DTC	P0224/2	Intermittent Failure with Spare Accelerator Sensor
------------	----------------	---

DTC Detecting Conditions

1 - Precondition; 2 - Detecting condition(s); 3 - Flashing pattern of failure indicator	Check points
1. Engine running. 2. Unconfirmed error detected 10 times. 3: Does not flash.	Connector Harness Spare accelerator sensor

Movement at Error occurrence

Error Mode	[Run As Is]: After detecting the error, the system lets the engine continue to run without any restrictions.
Run restricted?	No.
Recovery Conditions	No.
Remarks	

Estimation of Failure cause/Error condition

- The connector may not be properly connected.
- Wiring defect of the harness
 - Spare accelerator sensor signal wire may be disconnected or short-circuited with GND or power supply.
 - Sensor 5V wire may be disconnected, or short-circuited with GND or power supply.
 - Sensor GND wire may be disconnected.
- The spare accelerator sensor may be faulty.
 - Spare accelerator sensor wiring may be disconnected or short-circuited.

Diagnosis Description

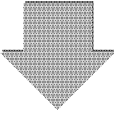
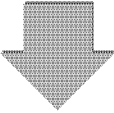
1) Initial diagnosis with the diagnosis tool	<ul style="list-style-type: none">• Check the fault indication.• Check the sensor voltage. <p>*For details of the method and the procedure of diagnosis, see P.1-148</p>
	
2) Check of connectors/wiring	<ul style="list-style-type: none">• Before beginning your work, be sure to turn off the key switch.• Check that the connector of the spare accelerator sensor is correctly inserted.• Check that the wiring of the spare accelerator sensor is not disconnected or the insulation of the wiring is not peeled.
	
3) Failure Diagnostic Work	<ul style="list-style-type: none">• Check the resistance value of the spare accelerator sensor.• Check the harness for correct continuity.• Check the output voltage of the spare accelerator sensor. <p>*For details of the method and the procedure of diagnosis, see P.1-148</p>

(4) P1225/1: Spare Accelerator Sensor Error (foot pedal-close position)

DTC	P1225/1	Spare Accelerator Sensor Error (foot pedal-close position)
------------	----------------	---

DTC Detecting Conditions

1 - Precondition; 2 - Detecting condition(s); 3 - Flashing pattern of failure indicator	Check points
1. Key switch ON. 2. With sensor voltage at or below 0.65[V], foot pedal Normally Open switch detected being ON or foot pedal Normally Closed Switch detected being OFF. 3. One flash followed by eight flashes	Harness Foot pedal

Movement at Error occurrence

	Error detection of main accelerator sensor	
	Unavailable	Available
Error Mode	[Run As Is]: The engine continues to run using the main accelerator sensor.	[Run Under Restrictions]: The engine runs at a constant rotational speed.
Run restricted?	No.	Yes: The target speed is set to the "on-error target speed (standard value: 1500[min^{-1}])" or "pre-error target speed".
Recovery Conditions	No.	No.
Remarks		

Estimation of Failure cause/Error condition

- The connector may not be properly connected.
- Wiring defect of the harness
 - The wiring for the foot pedal Normally Closed switch may be disconnected.
 - The wiring for the foot pedal Normally Open switch may be short-circuited with GND.
- The foot pedal may be faulty.
 - The inner wiring may be disconnected or short-circuited with GND.
- The E-ECU internal circuitry may be faulty.

Diagnosis Description

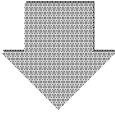
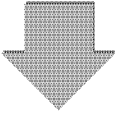
1) Initial diagnosis with the diagnosis tool	<ul style="list-style-type: none">• Check the fault indication.• Check that the foot pedal movement is correctly recognized. <p>*For details of the method and the procedure of diagnosis, see P.1-144</p>
	
2) Check of connectors/wiring	<ul style="list-style-type: none">• Before beginning your work, be sure to turn off the key switch.• Check that the connector of the foot pedal is correctly inserted.• Check that the wiring of the foot pedal is not disconnected or the insulation of the wiring is not peeled.
	
3) Failure Diagnostic Work	<ul style="list-style-type: none">• Check the foot pedal for correct continuity.• Check the harness for correct continuity. <p>*For details of the method and the procedure of diagnosis, see P.1-144</p>

(5) P1226/0: Spare Accelerator Sensor Error (foot pedal-open position)

DTC	P1226/0	Spare Accelerator Sensor Error (foot pedal-open position)
------------	----------------	--

DTC Detecting Conditions

1 - Precondition; 2 - Detecting condition(s); 3 - Flashing pattern of failure indicator	Check points
1. Key switch ON. 2. With sensor voltage 1.1[V] and above, foot pedal Normally Open switch detected being OFF or foot pedal Normally Closed Switch detected being ON. 3. One flash followed by eight flashes	Harness Foot pedal

Movement at Error occurrence

	Error detection of main accelerator sensor	
	Unavailable	Available
Error Mode	[Run As Is]: The engine continues to run using the main accelerator sensor.	[Run Under Restrictions]: The engine runs at a constant rotational speed.
Run restricted?	No.	Yes: The target speed is set to the "on-error target speed (standard value: 1500[min^{-1}])" or "pre-error target speed".
Recovery Conditions	No.	No.
Remarks		

Estimation of Failure cause/Error condition

- The connector may not be properly connected.
- Wiring defect of the harness
 - The wiring for the foot pedal Normally Open switch may be disconnected.
 - The wiring for the foot pedal Normally Closed switch may be short-circuited with GND.
- The foot pedal may be faulty.
 - The inner wiring may be disconnected or short-circuited with GND.
- The E-ECU internal circuitry may be faulty.

Diagnosis Description

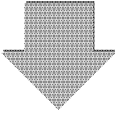
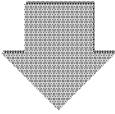
1) Initial diagnosis with the diagnosis tool	<ul style="list-style-type: none">• Check the fault indication.• Check that the foot pedal movement is correctly recognized. <p>*For details of the method and the procedure of diagnosis, see P.1-144</p>
	
2) Check of connectors/wiring	<ul style="list-style-type: none">• Before beginning your work, be sure to turn off the key switch.• Check that the connector of the foot pedal is correctly inserted.• Check that the wiring of the foot pedal is not disconnected or the insulation of the wiring is not peeled.
	
3) Failure Diagnostic Work	<ul style="list-style-type: none">• Check the foot pedal for correct continuity.• Check the harness for correct continuity. <p>*For details of the method and the procedure of diagnosis, see P.1-144</p>

(6) P1227/8: Failure with Spare Accelerator Sensor (Pulse Communication)

DTC	P1227/8	Failure with Spare Accelerator Sensor (Pulse Communication)
------------	----------------	--

* This DTC is output when a pulse accelerator is used.

DTC Detecting Conditions

1 - Precondition; 2 - Detecting condition(s); 3 - Flashing pattern of failure indicator	Check points
1. Key switch ON. 2. No pulse accelerator signal input 3. One flash followed by eight flashes	Harness

Movement at Error occurrence

	CAN communication error detection	
	Unavailable	Available
Error Mode	[Run As Is]: After detecting the error, the system lets the engine continue to run without any restrictions.	[Run Under Restrictions]: The engine runs at a constant rotational speed.
Run restricted?	No.	Yes: The target speed is set to the "on-error target speed (standard value: 1500[min^{-1}])" or "pre-error target speed".
Recovery Conditions	Yes: The error is automatically reset when a normal data is received.	Yes: The error is automatically reset when a normal data is received.
Remarks		

Estimation of Failure cause/Error condition

- Wiring defect of the harness
 - The pulse accelerator's signal wires may be disconnected or short-circuited with GND.
- Source circuitry fault of the pulse accelerator signal
- The E-ECU internal circuitry may be faulty.

Diagnosis Description

1) Initial diagnosis
with the diagnosis
tool

- Check the fault indication.

*For details of the method and the procedure of diagnosis, see P.1-152

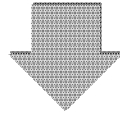

2) Check of
connectors/wiring

- Before beginning your work, be sure to turn off the key switch.
- Check that a source unit of the pulse accelerator signal and ECU are correctly connected.
- Check that the wiring of the pulse accelerator signal is not disconnected or the insulation of the wiring is not peeled.

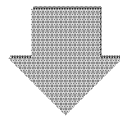

3) Failure Diagnostic
Work

- Check the harness for correct continuity.

*For details of the method and the procedure of diagnosis, see P.1-152

Atmospheric pressure sensor (option)

(1) P2228/4: Failure with Atmospheric Pressure Sensor (Low Voltage)

DTC	P2228/4	Failure with Atmospheric Pressure Sensor (Low Voltage)
-----	---------	--

DTC Detecting Conditions

1 - Precondition; 2 - Detecting condition(s); 3 - Flashing pattern of failure indicator	Check points
1. Key switch ON. 2. Sensor voltage 0.2 [V] or higher. 3. One flash followed by nine flashes.	Harness Atmospheric pressure sensor

Movement at Error occurrence

Error Mode	[Run Under Restrictions]: The engine continues to run with the atmospheric pressure unchanged from the pre-error value.
Run restricted?	Yes: The altitude compensation function is disabled.
Recovery Conditions	No.
Remarks	

Estimation of Failure cause/Error condition

- The connector may not be properly connected.
- Wiring defect of the harness
 - The atmospheric pressure sensor's signal wires may be disconnected or short-circuited with GND.
 - The SENSOR 5V wire may be disconnected or short-circuited with GND.
 - The SENSOR GND wire may be short-circuited with POWER SUPPLY (*NOTE).
- ***NOTE) If the SENSOR GND wire is short-circuited with POWER SUPPLY, the E-ECU's power supply line fuse 10A might be blown. With this fuse blown, the E-ECU may fail to detect/indicate the error, and to store the error history.**
- The atmospheric pressure sensor may be faulty.
 - Sensor output defect by a disconnection of the atmospheric pressure sensor inner wiring or a sliding resistance increase
- The E-ECU internal circuitry may be faulty.

Diagnosis Description

1) Initial diagnosis with the diagnosis tool	<ul style="list-style-type: none">• Check the fault indication.• Check the sensor voltage. <p>*For details of the method and the procedure of diagnosis, see P.1-148</p>
--	---

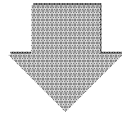

2) Check of connectors/wiring	<ul style="list-style-type: none">• Before beginning your work, be sure to turn off the key switch.• Check that the connector of the atmospheric pressure sensor is correctly inserted.• Check that the wiring of the atmospheric pressure sensor is not disconnected or the insulation of the wiring is not peeled.
-------------------------------	--

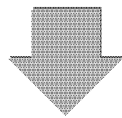

3) Failure Diagnostic Work	<ul style="list-style-type: none">• Check the resistance value of the atmospheric pressure sensor.• Check the harness for correct continuity.• Check the output voltage of the atmospheric pressure sensor. <p>*For details of the method and the procedure of diagnosis, see P.1-148</p>
----------------------------	---

(2) P2229/3: Failure with Atmospheric Pressure Sensor (High Voltage)

DTC	P2229/3	Failure with Atmospheric Pressure Sensor (High Voltage)
-----	---------	---

DTC Detecting Conditions

1 - Precondition; 2 - Detecting condition(s); 3 - Flashing pattern of failure indicator	Check points
1. Key switch ON. 2. Sensor voltage 4.8 [V] or higher. 3. One flash followed by nine flashes.	Harness Atmospheric pressure sensor

Movement at Error occurrence

Error Mode	[Run Under Restrictions]: The engine continues to run with the atmospheric pressure unchanged from the pre-error value.
Run restricted?	Yes: The altitude compensation function is disabled.
Recovery Conditions	No.
Remarks	

Estimation of Failure cause/Error condition

- The connector may not be properly connected.
- Wiring defect of the harness
 - The SENSOR GND wire may be disconnected.
 - The sensor signal wire may be short-circuited with POWER SUPPLY.
- The atmospheric pressure sensor may be faulty.
 - Sensor output defect by a short circuit with power supply of the atmospheric pressure sensor inner wiring
- The E-ECU internal circuitry may be faulty.

Diagnosis Description

1) Initial diagnosis with the diagnosis tool	<ul style="list-style-type: none">• Check the fault indication.• Check the sensor voltage. <p>*For details of the method and the procedure of diagnosis, see P.1-148</p>
--	---

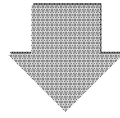

2) Check of connectors/wiring	<ul style="list-style-type: none">• Before beginning your work, be sure to turn off the key switch.• Check that the connector of the atmospheric pressure sensor is correctly inserted.• Check that the wiring of the atmospheric pressure sensor is not disconnected or the insulation of the wiring is not peeled.
-------------------------------	--

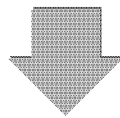

3) Failure Diagnostic Work	<ul style="list-style-type: none">• Check the resistance value of the atmospheric pressure sensor.• Check the harness for correct continuity.• Check the output voltage of the atmospheric pressure sensor. <p>*For details of the method and the procedure of diagnosis, see P.1-148</p>
----------------------------	---

(3) P2230/2: Intermittent Failure with Atmospheric Pressure Sensor

DTC	P2230/2	Intermittent Failure with Atmospheric Pressure Sensor
------------	----------------	--

DTC Detecting Conditions

1 - Precondition; 2 - Detecting condition(s); 3 - Flashing pattern of failure indicator	Check points
1. Engine running. 2. Unconfirmed error detected 10 times. 3: Does not flash.	Connector Harness Atmospheric pressure sensor

Movement at Error occurrence

Error Mode	[Run As Is]: After detecting the error, the system lets the engine continue to run without any restrictions.
Run restricted?	No.
Recovery Conditions	No.
Remarks	

Estimation of Failure cause/Error condition

- The connector may not be properly connected.
- Wiring defect of the harness
 - Accelerator sensor signal wire may be disconnected, or short-circuited with GND or power supply.
 - Sensor 5V wire may be disconnected, or short-circuited with GND or power supply.
 - Sensor GND wire may be disconnected.
- The atmospheric pressure sensor may be faulty.
 - Inner wiring of atmospheric pressure sensor may be disconnected, or short circuited.

Diagnosis Description

1) Initial diagnosis with the diagnosis tool	<ul style="list-style-type: none">• Check the fault indication.• Check the sensor voltage. <p>*For details of the method and the procedure of diagnosis, see P.1-148</p>
--	---

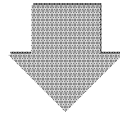

2) Check of connectors/wiring	<ul style="list-style-type: none">• Before beginning your work, be sure to turn off the key switch.• Check that the connector of the atmospheric pressure sensor is correctly inserted.• Check that the wiring of the atmospheric pressure sensor is not disconnected or the insulation of the wiring is not peeled.
-------------------------------	--

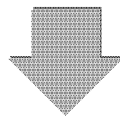

3) Failure Diagnostic Work	<ul style="list-style-type: none">• Check the resistance value of the atmospheric pressure sensor.• Check the harness for correct continuity.• Check the output voltage of the atmospheric pressure sensor. <p>*For details of the method and the procedure of diagnosis, see P.1-148</p>
----------------------------	---

ECU Temperature Sensor

(1) P0668/4: Failure with ECU Temperature Sensor (Low Voltage)

DTC	P0668/4	Failure with ECU Temperature Sensor (Low Voltage)
-----	---------	---

DTC Detecting Conditions

1 - Precondition; 2 - Detecting condition(s); 3 - Flashing pattern of failure indicator	Check points
1. Key switch ON. 2. Sensor voltage 1.0 [V] (at 140°C) or lower. 3. Four flashes followed by one flash.	E-ECU

Movement at Error occurrence

Error Mode	[Operation Continuation]: No obstacles to control the engine. The engine continues to run with the ECU temperature set to the default of 30[°C].
Run restricted?	No.
Recovery Conditions	Yes: This error will be automatically reset when a normal sensor voltage (1.0 to 4.6[V]) is input.
Remarks	

Estimation of Failure cause/Error condition

- The E-ECU internal circuitry may be faulty.

Diagnosis Description

1) Initial diagnosis with the diagnosis tool	<ul style="list-style-type: none"> • Check the fault indication. • Check the ECU temperature. <p>*For details of the method and the procedure of diagnosis, see P.1-154</p>
--	---

(2) P0669/3: Failure with ECU Temperature Sensor (High Voltage)

DTC	P0669/3	Failure with ECU Temperature Sensor (High Voltage)
-----	---------	--

DTC Detecting Conditions

1 - Precondition; 2 - Detecting condition(s); 3 - Flashing pattern of failure indicator	Check points
1. Key switch ON. 2. Sensor voltage 4.6 [V] (at -45°C) or lower. 3. Four flashes followed by one flash.	E-ECU

Movement at Error occurrence

Error Mode	[Operation Continuation]: No obstacles to control the engine. The engine continues to run with the ECU temperature set to the default of 30 [°C].
Run restricted?	No.
Recovery Conditions	Yes: This error will be automatically reset when a normal sensor voltage (0.2 to 4.6[V]) is input.
Remarks	

Estimation of Failure cause/Error condition

- The E-ECU internal circuitry may be faulty.

Diagnosis Description

1) Initial diagnosis with the diagnosis tool	<ul style="list-style-type: none"> • Check the fault indication. • Check the ECU temperature. <p>*For details of the method and the procedure of diagnosis, see P.1-154</p>
--	---

(3) P1664/2: Intermittent Failure with ECU Temperature Sensor

DTC	P1664/2	Intermittent Failure WITH ECU Temperature Sensor
-----	---------	--

DTC Detecting Conditions

1 - Precondition; 2 - Detecting condition(s); 3 - Flashing pattern of failure indicator	Check points
1. Engine running. 2. Unconfirmed error detected 10 times. 3: Does not flash.	E-ECU

Movement at Error occurrence

Error Mode	[Run As Is]: After detecting the error, the system lets the engine continue to run without any restrictions.
Run restricted?	No.
Recovery Conditions	No.
Remarks	

Estimation of Failure cause/Error condition

- The E-ECU internal circuitry may be faulty.

Diagnosis Description

1) Initial diagnosis with the diagnosis tool	<ul style="list-style-type: none"> • Check the fault indication. • Check the ECU temperature. <p>*For details of the method and the procedure of diagnosis, see P.1-154</p>
--	---

(4) P0634/0: ECU Temperature Rise Alarm

DTC	P0634/0	ECU Temperature Rise Alarm
-----	---------	----------------------------

DTC Detecting Conditions

1 - Precondition; 2 - Detecting condition(s); 3 - Flashing pattern of failure indicator	Check points
1. Key switch ON. 2. ECU internal temperature is 150 [°C] or higher. 3. Two flashes followed by five flashes.	E-ECU

Movement at Error occurrence

	Setting of response to ECU temperature rise error	
	Unavailable	Available
Error Mode	[Run As Is]: After detecting the error, the system lets the engine continue to run without any restrictions.	[Run Under Restrictions]: The engine continues to run under restrictions.
Run restricted?	No.	Yes: The system restricts the High idle speed or engine power.
Recovery Conditions	Yes: This error is automatically reset when the normal internal temperature (under 100[°C]) of ECU is detected.	Yes: This error is automatically reset when the normal internal temperature (under 100[°C]) of ECU is detected.
Remarks		

Estimation of Failure cause/Error condition

- The ambient temperature around the ECU may be too high.
- The E-ECU internal circuitry may be faulty.

Diagnosis Description

1) Initial diagnosis with the diagnosis tool	<ul style="list-style-type: none">• Check the fault indication.• Check the ECU temperature. <p>*For details of the method and the procedure of diagnosis, see P.1-154</p>
--	--

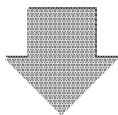

2) Engine Inspection	<ul style="list-style-type: none">• Turn the key switch off to stop the engine.• Inspect around the E-ECU.• After a little, turn the key switch on to check if the DTC is detected. <p>*For description and procedure of engine inspection, see the Service manual (section "Engine").</p>
----------------------	--

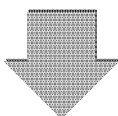

3) Failure Diagnostic Work	<ul style="list-style-type: none">• Check the ECU temperature sensor. <p>*For details of the method and the procedure of diagnosis, see P.1-154</p>
----------------------------	---

Cooling water temperature sensor**(1) P0117/4: Failure with Cooling Water Temperature Sensor (Low Voltage)**

DTC	P0117/4	Failure with Cooling Water Temperature Sensor (Low Voltage)
------------	----------------	--

DTC Detecting Conditions

1 - Precondition; 2 - Detecting condition(s); 3 - Flashing pattern of failure indicator	Check points
1. Key switch ON. 2. Sensor voltage 0.2 [V] or lower. 3. Four flashes.	Connector Harness Cooling water temperature sensor E-ECU

Movement at Error occurrence

	In the case of a system with EGR	In the case of a system without EGR
Error Mode	[Run Under Restrictions]: The engine continues to run under restrictions.	[Run As Is]:
	The engine continues to run with the cooling water temperature set to the default of 30[°C].	
Run restricted?	Yes: The system restricts the High idle speed or engine power.	No.
Recovery Conditions	No.	Yes: This error will be automatically reset when a normal sensor voltage (0.2 to 4.8[V]) is kept.
Remarks	The restriction similar to one applied against EGR errors is applied.	

Estimation of Failure cause/Error condition

- The connector may not be properly connected.
- Wiring defect of the harness
 - The cooling water temperature sensor's signal wires may be short-circuited with GND.
 - The cooling water temperature sensor's GND wire may be short-circuited with POWER SUPPLY.
- The cooling water temperature sensor may be faulty.
 - Output defect of the cooling water temperature signal by the inner wiring short-circuited with GND.
- The E-ECU internal circuitry may be faulty.

Diagnosis Description

1) Initial diagnosis with the diagnosis tool	<ul style="list-style-type: none">• Check the fault indication.• Check the sensor voltage. <p>*For details of the method and the procedure of diagnosis, see P.1-156</p>
--	---

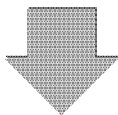

2) Check of connectors/wiring	<ul style="list-style-type: none">• Before beginning your work, be sure to turn off the key switch.• Check that the connector of the cooling water temperature sensor is correctly inserted.• Check that the wiring of the cooling water temperature sensor is not disconnected or the insulation of the wiring is not peeled.
-------------------------------	--

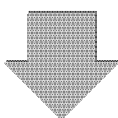

3) Failure Diagnostic Work	<ul style="list-style-type: none">• Check the resistance value of the cooling water temperature sensor.• Check the harness for correct continuity.• Check the output voltage of the cooling water temperature sensor. <p>*For details of the method and the procedure of diagnosis, see P.1-156</p>
----------------------------	---

(2) P0118/3: Failure with Cooling Water Temperature Sensor (High Voltage)

DTC	P0118/3	Failure with Cooling Water Temperature Sensor (High Voltage)
-----	---------	--

DTC Detecting Conditions

1 - Precondition; 2 - Detecting condition(s); 3 - Flashing pattern of failure indicator	Check points
1. Key switch ON. 2. Sensor voltage 4.8 [V] or higher. 3. Four flashes.	Connector Harness Cooling water temperature sensor E-ECU

Movement at Error occurrence

	In the case of a system with EGR	In the case of a system without EGR
Error Mode	[Run Under Restrictions]: The engine continues to run under restrictions.	[Run As Is]:
	The engine continues to run with the cooling water temperature set to the default of 30 [°C].	
Run restricted?	Yes: The system restricts the High idle speed or engine power.	No.
Recovery Conditions	No.	Yes: This error will be automatically reset when a normal sensor voltage (0.2 to 4.8[V]) is kept.
Remarks	The restriction similar to one applied against EGR errors is applied.	

Estimation of Failure cause/Error condition

- The connector may not be properly connected.
- Wiring defect of the harness
 - The cooling water temperature sensor's signal wires may be disconnected or short-circuited with POWER SUPPLY.
 - The cooling water temperature GND wire may be disconnected.
- The cooling water temperature sensor may be faulty.
 - Output defect of the cooling water temperature signal by the inner wiring disconnection
- The E-ECU internal circuitry may be faulty.

Diagnosis Description

1) Initial diagnosis with the diagnosis tool	<ul style="list-style-type: none"> • Check the fault indication. • Check the sensor voltage. <p>*For details of the method and the procedure of diagnosis, see P.1-156</p>
--	--

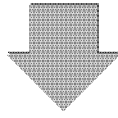

2) Check of connectors/wiring	<ul style="list-style-type: none"> • Before beginning your work, be sure to turn off the key switch. • Check that the connector of the cooling water temperature sensor is correctly inserted. • Check that the wiring of the cooling water temperature sensor is not disconnected or the insulation of the wiring is not peeled.
-------------------------------	--

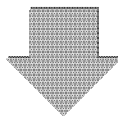

3) Failure Diagnostic Work	<ul style="list-style-type: none"> • Check the resistance value of the cooling water temperature sensor. • Check the harness for correct continuity. • Check the output voltage of the cooling water temperature sensor. <p>*For details of the method and the procedure of diagnosis, see P.1-156</p>
----------------------------	---

(3) P0119/2: Intermittent Failure with Cooling Water Temperature Sensor

DTC	P0119/2	Intermittent Failure with Cooling Water Temperature Sensor
-----	---------	--

DTC Detecting Conditions

1 - Precondition; 2 - Detecting condition(s); 3 - Flashing pattern of failure indicator	Check points
1. Engine running. 2. Unconfirmed error detected 10 times. 3: Does not flash.	Connector Harness High-accuracy cooling water temperature sensor E-ECU

Movement at Error occurrence

Error Mode	[Run As Is]: After detecting the error, the system lets the engine continue to run without any restrictions.
Run restricted?	No.
Recovery Conditions	No.
Remarks	

Estimation of Failure cause/Error condition

- The connector may not be properly connected.
- Wiring defect of the harness
 - The cooling water temperature sensor's signal wires may be short-circuited with GND.
 - The cooling water temperature sensor's signal wires may be disconnected or short-circuited with POWER SUPPLY.
 - GND wire of the cooling water temperature sensor may be disconnected.
- The cooling water temperature sensor may be faulty.
 - Signal wire in the sensor may be disconnected, or short circuited.
 - Sensor GND wire in the sensor may be disconnected.

Diagnosis Description

1) Initial diagnosis with the diagnosis tool	<ul style="list-style-type: none">• Check the fault indication.• Check the sensor voltage. <p>*For details of the method and the procedure of diagnosis, see P.1-156</p>
--	---

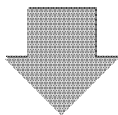

2) Check of connectors/wiring	<ul style="list-style-type: none">• Before beginning your work, be sure to turn off the key switch.• Check that the connector of the cooling water temperature sensor is correctly inserted.• Check that the wiring of the cooling water temperature sensor is not disconnected or the insulation of the wiring is not peeled.
-------------------------------	--

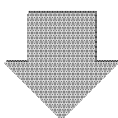

3) Failure Diagnostic Work	<ul style="list-style-type: none">• Check the resistance value of the cooling water temperature sensor.• Check the harness for correct continuity.• Check the output voltage of the cooling water temperature sensor. <p>*For details of the method and the procedure of diagnosis, see P.1-156</p>
----------------------------	---

(4) P0217/0: Cooling Water Temperature Rise Alarm

DTC	P0217/0	Cooling Water Temperature Rise Alarm
-----	---------	--------------------------------------

DTC Detecting Conditions

1 - Precondition; 2 - Detecting condition(s); 3 - Flashing pattern of failure indicator	Check points
1. Key switch ON. 2. Cooling water temperature 115[°C] or higher. 3. Three flashes followed by six flashes.	Engine cooling water level Engine cooling system Cooling Water Temperature Sensor

Movement at Error occurrence

	Setting of response to cooling water temperature rise error	
	Unavailable	Available
Error Mode	[Run As Is]: After detecting the error, the system lets the engine continue to run without any restrictions.	[Run Under Restrictions]: The engine continues to run under restrictions.
Run restricted?	No.	Yes: The system restricts the High idle speed or engine power.
Recovery Conditions	Yes: This error is automatically reset when the normal cooling water temperature (under 110[°C]) is detected.	Yes: This error is automatically reset when the normal cooling water temperature (under 110[°C]) is detected.
Remarks		

Estimation of Failure cause/Error condition

- The engine may be overheated.
- The engine cooling water level may be too low.
- The engine cooling system may be faulty.
- The cooling water temperature sensor may be faulty.

Diagnosis Description

1) Initial diagnosis with the diagnosis tool	<ul style="list-style-type: none">• Check the fault indication.• Check the cooling water temperature and the sensor voltage. <p>*For details of the method and the procedure of diagnosis, see P.1-156</p>
--	---

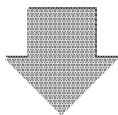

2) Check of connectors/wiring	<ul style="list-style-type: none">• Turn the key switch off to stop the engine.• Check the engine cooling system.• After a little, turn the key switch on to check if the DTC is detected. <p>*For description and procedure of engine inspection, see the Service manual ("Engine").</p>
-------------------------------	---

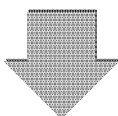

3) Failure Diagnostic Work	<ul style="list-style-type: none">• Check the cooling water temperature sensor system. <p>*For details of the method and the procedure of diagnosis, see P.1-156</p>
----------------------------	--

SENSOR 5V

(1) P0642/4: Failure with SENSOR 5V (Low Voltage)

DTC	P0642/4	Failure with SENSOR 5V (Low Voltage)
-----	---------	--------------------------------------

DTC Detecting Conditions

1 - Precondition; 2 - Detecting condition(s); 3 - Flashing pattern of failure indicator	Check points
1. Key switch ON. 2. SENSOR 5V monitoring voltage 4.5 [V] or lower. 3. Two flashes followed by four flashes.	Harness E-ECU

Movement at Error occurrence

Error Mode	[Operation Continuation]: After detecting the error, the system lets the engine continue to run without any restrictions.
Run restricted?	No.
Recovery Conditions	No.
Remarks	

Estimation of Failure cause/Error condition

- Wiring defect of the harness
 - The SENSOR 5V wire may be short-circuited with GND.
- The E-ECU internal circuitry may be faulty.

Diagnosis Description

1) Initial diagnosis with the diagnosis tool	<ul style="list-style-type: none"> • Check the fault indication. • Check the voltage of the Sensor 5V . *For details of the method and the procedure of diagnosis, see P.1-160
--	--

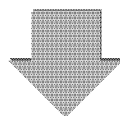

2) Check of connectors/wiring	<ul style="list-style-type: none"> • Before beginning your work, be sure to turn off the key switch. • Check that the insulation of the Sensor 5V is not peeled.
-------------------------------	--

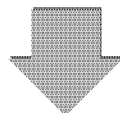

3) Failure Diagnostic Work	<ul style="list-style-type: none"> • Check the harness for correct continuity. • Check the output voltage of the E-ECU (voltage of the sensor 5V line). *For details of the method and the procedure of diagnosis, see P.1-160
----------------------------	--

(2) P0643/3: Failure with SENSOR 5V (High Voltage)

DTC	P0643/3	Failure with SENSOR 5V (High Voltage)
------------	----------------	--

DTC Detecting Conditions

1 - Precondition; 2 - Detecting condition(s); 3 - Flashing pattern of failure indicator	Check points
1. Key switch ON. 2. SENSOR 5V monitoring voltage 5.5 [V] or higher. 3. Two flashes followed by four flashes.	Harness E-ECU

Movement at Error occurrence

Error Mode	[Run As Is]:After detecting the error, the system lets the engine continue to run without any restrictions.
Run restricted?	No.
Recovery Conditions	No.
Remarks	

Estimation of Failure cause/Error condition

- Wiring defect of the harness
 - The SENSOR GND wire may be disconnected.
 - The SENSOR 5V wire may be short-circuited with POWER SUPPLY.
- The E-ECU internal circuitry may be faulty.

Diagnosis Description

1) Initial diagnosis with the diagnosis tool	<ul style="list-style-type: none"> • Check the fault indication. • Check the voltage of the Sensor 5V . *For details of the method and the procedure of diagnosis, see P.1-160
--	--

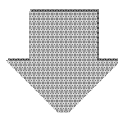

2) Check of connectors/wiring	<ul style="list-style-type: none"> • Before beginning your work, be sure to turn off the key switch. • Check that the Sensor 5V line and sensor GND line are not disconnected or the insulation of the wiring is not peeled.
-------------------------------	--

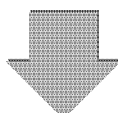

3) Failure Diagnostic Work	<ul style="list-style-type: none"> • Check the harness for correct continuity. • Check the output voltage of the E-ECU (voltage of the sensor 5V line). *For details of the method and the procedure of diagnosis, see P.1-160
----------------------------	--

(3) P1644/2: Intermittent Failure with SENSOR 5V

DTC	P1644/2	Intermittent Failure with SENSOR 5V
-----	---------	-------------------------------------

DTC Detecting Conditions

1 - Precondition; 2 - Detecting condition(s); 3 - Flashing pattern of failure indicator	Check points
1. Engine running. 2. Unconfirmed error detected 10 times. 3: Does not flash.	Harness E-ECU

Movement at Error occurrence

Error Mode	[Operation Continuation]: After detecting the error, the system lets the engine continue to run without any restrictions.
Run restricted?	No.
Recovery Conditions	No.
Remarks	

Estimation of Failure cause/Error condition

- Wiring defect of the harness
 - The SENSOR 5V wire may be short-circuited with power supply or GND.
 - Sensor GND wire may be disconnected.
- The E-ECU internal circuitry may be faulty.

Diagnosis Description

1) Initial diagnosis with the diagnosis tool	<ul style="list-style-type: none"> • Check the fault indication. • Check the voltage of the Sensor 5V . *For details of the method and the procedure of diagnosis, see P.1-160
--	--

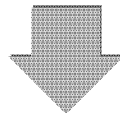

2) Check of connectors/wiring	<ul style="list-style-type: none"> • Before beginning your work, be sure to turn off the key switch. • Check that the Sensor 5V line and sensor GND line are not disconnected or the insulation of the wiring is not peeled.
-------------------------------	--

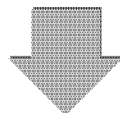

3) Failure Diagnostic Work	<ul style="list-style-type: none"> • Check the harness for correct continuity. • Check the output voltage of the E-ECU (voltage of the sensor 5V line). *For details of the method and the procedure of diagnosis, see P.1-160
----------------------------	--

Power supply Voltage**(1) P0562/1: Power Supply Voltage Error (Low Voltage)**

DTC	P0562/1	Power Supply Voltage Error (Low Voltage)
-----	---------	--

DTC Detecting Conditions

1 - Precondition; 2 - Detecting condition(s); 3 - Flashing pattern of failure indicator	Check points
1. Engine running. 2. E-ECU supply voltage below 10[V] 3. Two flashes followed by three flashes.	Battery alternator Harness

Movement at Error occurrence

Error Mode	[Operation Continuation]: After detecting the error, the system lets the engine continue to run without any restrictions.
Run restricted?	No.
Recovery Conditions	Yes: This error will be automatically reset when a normal supply voltage (10 to 16[V]) is input.
Remarks	

Estimation of Failure cause/Error condition

- The battery may be deteriorated.
- The battery connection may be miswired.
- The alternator may be faulty.
- The harness may be disconnected or short-circuited.
- The E-ECU internal circuitry may be faulty.

Diagnosis Description

- | | |
|--|--|
| 1) Initial diagnosis with the diagnosis tool | <ul style="list-style-type: none">• Check the fault indication.• Check the battery voltage. |
|--|--|

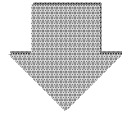

- | | |
|----------------------|--|
| 2) Engine Inspection | <ul style="list-style-type: none">• Turn the key switch off to stop the engine.• Check the battery voltage using a circuit tester.• Inspect the charging system of the engine .• After a little, turn the key switch on to check if the DTC is detected. <p>*For description and procedure of engine inspection, see the Service manual ("Engine").</p> |
|----------------------|--|

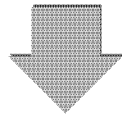

- | | |
|----------------------------|--|
| 3) Failure Diagnostic Work | <ul style="list-style-type: none">• Check that the battery wiring is not disconnected or the insulation of the wiring is not peeled. |
|----------------------------|--|

(2) P0563/0: Power Supply Voltage Error (High Voltage)

DTC	P0563/0	Power Supply Voltage Error (High Voltage)
-----	---------	---

DTC Detecting Conditions

1 - Precondition; 2 - Detecting condition(s); 3 - Flashing pattern of failure indicator	Check points
1. Engine running. 2. E-ECU supply voltage over 16[V] 3. Two flashes followed by three flashes.	Battery alternator Harness

Movement at Error occurrence

Error Mode	[Operation Continuation]: After detecting the error, the system lets the engine continue to run without any restrictions.
Run restricted?	No.
Recovery Conditions	Yes: This error will be automatically reset when a normal supply voltage (10 to 16[V]) is input.
Remarks	

Estimation of Failure cause/Error condition

- An incompatible battery (such as a 24V battery) may be used.
- The battery connection may be miswired.
- The alternator may be faulty.
- The harness may be disconnected or short-circuited.
- The E-ECU internal circuitry may be faulty.

Diagnosis Description

- | | |
|--|--|
| 1) Initial diagnosis with the diagnosis tool | <ul style="list-style-type: none">• Check the fault indication.• Check the battery voltage. |
|--|--|

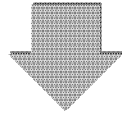

- | | |
|----------------------|--|
| 2) Engine Inspection | <ul style="list-style-type: none">• Turn the key switch off to stop the engine.• Check the battery voltage using a circuit tester.• Inspect the charging system of the engine .• After a little, turn the key switch on to check if the DTC is detected. <p>*For description and procedure of engine inspection, see the Service manual ("Engine").</p> |
|----------------------|--|

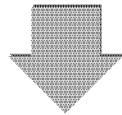

- | | |
|----------------------------|--|
| 3) Failure Diagnostic Work | <ul style="list-style-type: none">• Check that the battery wiring is not disconnected or the insulation of the wiring is not peeled. |
|----------------------------|--|

Pulse Sensor Related Failures

Speed Sensor

(1) P0340/4: Failure with Speed Sensor

DTC	P0340/4	Speed Sensor Error
------------	----------------	---------------------------

DTC Detecting Conditions

1 - Precondition; 2 - Detecting condition(s); 3 - Flashing pattern of failure indicator	Check points
1. Key switch START, engine running. 2. Speed sensor signal 0[min^{-1}] 3. Six flashes.	Connector Harness Speed Sensor E-ECU

Movement at Error occurrence

	Spare speed sensor setting	
	Unavailable	Available
Error Mode	[Stop Immediately]: The engine stops running.	[Run Under Restrictions]: The engine continues to run under restrictions with the spare speed sensor used instead.
Run restricted?	Yes: The rack actuator relay is turned OFF, and the rack position is forcibly set to the engine stop position.	Yes: The system restricts the High idle speed or engine power.
Recovery Conditions	Yes: Key switch START	Yes: Key switch START
Remarks		

Estimation of Failure cause/Error condition

- The connector may not be properly connected.
- Engine speed defect
 - Battery voltage descent at cold start etc.
 - Starter system failure
 - Fuel injection not available (fuel freezing)
 - Engine locked (seizure, freezing)
 - Battery voltage descent (over discharge, deterioration)
 - Load increase driven by the operating machine
- Wiring defect of the harness
 - The speed sensor's signal wires (+) and (-) may be disconnected or short-circuited with GND.
 - The starter signal wire may be short-circuited with POWER SUPPLY.
- The speed sensor may be faulty.
 - Output defect of the speed signal by a disconnection or a short circuit of the inner wiring
- The E-ECU internal circuitry may be faulty.

Diagnosis Description

1) Initial diagnosis with the diagnosis tool	<ul style="list-style-type: none">• Check the fault indication.• Check the engine speed. <p>*For details of the method and the procedure of diagnosis, see P.1-164</p>
--	---

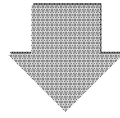

2) Check of connectors/wiring	<ul style="list-style-type: none">• Before beginning your work, be sure to turn off the key switch.• Check that the connector of the speed sensor is correctly inserted.• Check that the wiring of the speed sensor is not disconnected or the insulation of the wiring is not peeled.
-------------------------------	--

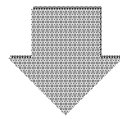

3) Failure Diagnostic Work	<ul style="list-style-type: none">• Check the resistance value of the speed sensor.• Check the harness for correct continuity. <p>*For details of the method and the procedure of diagnosis, see P.1-164</p>
----------------------------	---

Spare speed sensor (option)

(1) P1340/4: Failure with Spare Speed Sensor

DTC	P1340/4	Failure with Spare Speed Sensor
------------	----------------	--

DTC Detecting Conditions

1 - Precondition; 2 - Detecting condition(s); 3 - Flashing pattern of failure indicator	Check points
1. Engine running. 2. Spare speed sensor signal below 0[min^{-1}]. 3. One flash followed by another flash.	Connector Harness alternator E-ECU

Movement at Error occurrence

	Main speed sensor error detection	
	Unavailable	Available
Error Mode	[Run As Is]: After detecting the error, the system lets the engine continue to run without any restrictions.	[Stop Immediately]: The engine stops running.
Run restricted?	No.	Yes: The rack actuator relay is turned OFF, and the rack position is forcibly set to the engine stop position.
Recovery Conditions	No.	Yes:Key switch START
Remarks		

Estimation of Failure cause/Error condition

- The connector may not be properly connected.
- Output pulse voltage defect by low engine speed
- Output pulse defect by the battery over-charge
- Wiring defect of the harness
 - The spare speed sensor's signal wires may be disconnected or short-circuited with GND.
 - The alternator's terminals B and IG may be disconnected or short-circuited with GND.
- Output pulse defect by the alternator failure
- The E-ECU internal circuitry may be faulty.

Diagnosis Description

1) Initial diagnosis with the diagnosis tool	<ul style="list-style-type: none">• Check the fault indication.• Check the rotational speed of the spare speed sensor. <p>*For details of the method and the procedure of diagnosis, see P.1-167</p>
--	---

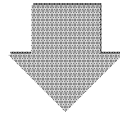

2) Check of connectors/wiring	<ul style="list-style-type: none">• Before beginning your work, be sure to turn off the key switch.• Check that the connector of the alternator is correctly inserted.• Check that the wiring of the alternator is not disconnected or the insulation of the wiring is not peeled.
-------------------------------	--

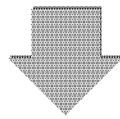

3) Failure Diagnostic Work	<ul style="list-style-type: none">• Check the battery voltage.• Check the harness for correct continuity. <p>*For details of the method and the procedure of diagnosis, see P.1-167</p>
----------------------------	--

Engine rotational speed

(1) P0219/0: Over speed error

DTC	P0219/0	Overspeed Error
------------	----------------	------------------------

DTC Detecting Conditions

1 - Precondition; 2 - Detecting condition(s); 3 - Flashing pattern of failure indicator	Check points
1. Engine running. 2. Sensor signal at or above the upper limit (High idle speed +600[min^{-1}]). 3. Two flashes followed by five flashes.	Harness Speed Sensor Rack actuator E-ECU

Movement at Error occurrence

Error Mode	[Stop Immediately]: The engine stops running.
Run restricted?	Yes: The rack actuator relay is turned OFF, and the rack position is forcibly set to the engine stop position.
Recovery Conditions	No.
Remarks	

Estimation of Failure cause/Error condition

- Wiring defect of the harness
 - The rack actuator wiring may be short-circuited with GND.
- False generation of speed sensor signal pulse
 - False wiring of the speed sensor
- Engine over speed loaded by the operating machine's drive
- Control error of the fuel injection pump
 - The rack actuator wiring may be short-circuited with GND.
- The E-ECU internal circuitry may be faulty.

Diagnosis Description

1) Initial diagnosis
with the diagnosis
tool

- Check the fault indication.

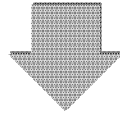

2) Engine Inspection

- Turn the key switch off to stop the engine.
- Inspect the engine and the operating machine.
- After a little, turn the key switch on to check if the DTC is detected.

*For description and procedure of engine inspection, see the Service manual ("Engine").

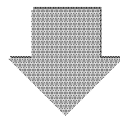

3) Failure Diagnostic
Work

- Check the Rack Actuator.

*For details of the method and the procedure of diagnosis, see P.1-167

Contact Output Related Failures

Rack actuator Relay

(1) P1222/4: Failure A with Rack Actuator Relay

DTC	P1222/4	Failure A with Rack Actuator Relay
-----	---------	------------------------------------

DTC Detecting Conditions

1 - Precondition; 2 - Detecting condition(s); 3 - Flashing pattern of failure indicator	Check points
1. Key switch ON. 2. Make an assessment logically as to followings. E-ECU detects the rack actuator relay turning ON during the command to turn OFF the rack actuator relay. 3. One flash followed by seven flashes.	Connector Harness Rack actuator Relay E-ECU

Movement at Error occurrence

Error Mode	[Stop Immediately]: The engine stops running.
Run restricted?	Yes: The rack actuator relay is turned OFF, and the rack position is forcibly set to the engine stop position.
Recovery Conditions	No.
Remarks	

Estimation of Failure cause/Error condition

- The connector may not be properly connected.
- Wiring defect of the harness
 - The rack actuator relay wiring may be disconnected or short-circuited with GND.
- The rack actuator relay may be faulty.
 - Inner wiring disconnection
- The E-ECU internal circuitry may be faulty.

Diagnosis Description

1) Initial diagnosis
with the diagnosis
tool

- Check the fault indication.
- Check the output signal of the rack actuator relay.
- Check the movement of the rack actuator relay by the active control function.

*For details of the method and the procedure of diagnosis, see P.1-170

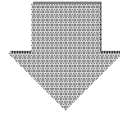

2) Check of
connectors/wiring

- Before beginning your work, be sure to turn off the key switch.
- Check that the connector of the rack actuator relay is correctly inserted.
- Check that the wiring of the rack actuator relay is not disconnected or the insulation of the wiring is not peeled.

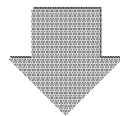

3) Failure Diagnostic
Work

- Check the resistance value of the rack actuator relay.
- Check the harness for correct continuity.

*For details of the method and the procedure of diagnosis, see P.1-170

(2) P1223/3: Failure B with Rack Actuator Relay

DTC	P1223/3	Failure B with Rack Actuator Relay
-----	---------	------------------------------------

DTC Detecting Conditions

1 - Precondition; 2 - Detecting condition(s); 3 - Flashing pattern of failure indicator	Check points
1. Key switch ON. 2. Make an assessment logically as to followings.E-ECU detects the rack actuator relay turning OFF during the command to turn ON the rack actuator relay. 3. One flash followed by seven flashes.	Connector Harness Rack actuator Relay E-ECU

Movement at Error occurrence

Error Mode	[Stop Immediately]: The engine stops running.
Run restricted?	Yes: The rack actuator relay is turned OFF, and the rack position is forcibly set to the engine stop position.
Recovery Conditions	No.
Remarks	

Estimation of Failure cause/Error condition

- Wiring defect of the harness
 - The rack actuator relay wiring may be short-circuited with POWER SUPPLY (*NOTE).
 - The rack actuator relay may be faulty.
 - Inner wiring short-circuited with POWER SUPPLY (*NOTE).
- *NOTE) If the rack actuator relay wire is short-circuited with POWER SUPPLY, inner circuit of E-ECU may fail before the E-ECU's power supply line fuse 10A is blown.In this case, the ECU fails to detect/indicate the error, and to store the error history.**
- The E-ECU internal circuitry may be faulty.

Diagnosis Description

1) Initial diagnosis with the diagnosis tool	<ul style="list-style-type: none">• Check the fault indication.• Check the output signal of the rack actuator relay.• Check the movement of the rack actuator relay by the active control function. <p>*For details of the method and the procedure of diagnosis, see P.1-170</p>
--	---

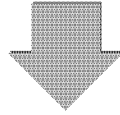

2) Check of connectors/wiring	<ul style="list-style-type: none">• Before beginning your work, be sure to turn off the key switch.• Check that the connector of the rack actuator relay is correctly inserted.• Check that the wiring of the rack actuator relay is not disconnected or the insulation of the wiring is not peeled.
-------------------------------	--

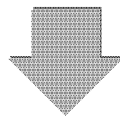

3) Failure Diagnostic Work	<ul style="list-style-type: none">• Check the resistance value of the rack actuator relay.• Check the harness for correct continuity. <p>*For details of the method and the procedure of diagnosis, see P.1-170</p>
----------------------------	--

(3) P1224/2: Intermittent Failure with Rack Actuator Relay

DTC	P1224/2	Intermittent Failure with Rack Actuator Relay
-----	---------	---

DTC Detecting Conditions

1 - Precondition; 2 - Detecting condition(s); 3 - Flashing pattern of failure indicator	Check points
1. Engine running. 2. Unconfirmed error detected 10 times. 3: Does not flash.	Connector Harness Rack actuator Relay E-ECU

Movement at Error occurrence

Error Mode	[Run As Is]: After detecting the error, the system lets the engine continue to run without any restrictions.
Run restricted?	No.
Recovery Conditions	No.
Remarks	

Estimation of Failure cause/Error condition

- The connector may not be properly connected.
- Wiring defect of the harness
 - The rack actuator relay wiring may be disconnected or short-circuited with GND.
- The E-ECU internal circuitry may be faulty.

Diagnosis Description

1) Initial diagnosis with the diagnosis tool	<ul style="list-style-type: none">• Check the fault indication.• Check the output signal of the rack actuator relay.• Check the movement of the rack actuator relay by the active control function. <p>*For details of the method and the procedure of diagnosis, see P.1-170</p>
--	---

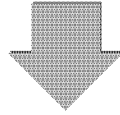

2) Check of connectors/wiring	<ul style="list-style-type: none">• Before beginning your work, be sure to turn off the key switch.• Check that the connector of the rack actuator relay is correctly inserted.• Check that the wiring of the rack actuator relay is not disconnected or the insulation of the wiring is not peeled.
-------------------------------	--

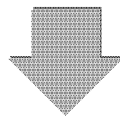

3) Failure Diagnostic Work	<ul style="list-style-type: none">• Check the resistance value of the rack actuator relay.• Check the harness for correct continuity. <p>*For details of the method and the procedure of diagnosis, see P.1-170</p>
----------------------------	--

Start Assist Relay**(1) P1232/4: Failure A with Start Assist Relay**

DTC	P1232/4	Failure A with Start Assist Relay
-----	---------	-----------------------------------

DTC Detecting Conditions

1 - Precondition; 2 - Detecting condition(s); 3 - Flashing pattern of failure indicator	Check points
1. Key switch ON. 2. Make an assessment logically as to followings. E-ECU detects the start assist relay turning ON during the command to turn OFF the start assist relay. 3. One flash followed by five flashes.	Connector Harness Start Assist Relay E-ECU

Movement at Error occurrence

Error Mode	[Run As Is]: After detecting the error, the system lets the engine continue to run without any restrictions.
Run restricted?	No.
Recovery Conditions	No.
Remarks	

Estimation of Failure cause/Error condition

- The connector may not be properly connected.
- Wiring defect of the harness
 - The start assist relay wiring may be disconnected or short-circuited with POWER SUPPLY.
- The start assist relay may be faulty.
 - Disconnection of Start Assist Relay inner wiring
- The E-ECU internal circuitry may be faulty.

Diagnosis Description

1) Initial diagnosis with the diagnosis tool	<ul style="list-style-type: none">• Check the fault indication.• Check the output signal of the start assist relay.• Check the movement of the start assist relay by the active control function. <p>*For details of the method and the procedure of diagnosis, see P.1-174</p>
--	---

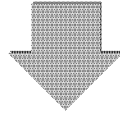

2) Check of connectors/wiring	<ul style="list-style-type: none">• Before beginning your work, be sure to turn off the key switch.• Check that the connector of the start assist relay is correctly inserted.• Check that the wiring of the start assist relay is not disconnected or the insulation of the wiring is not peeled.
-------------------------------	--

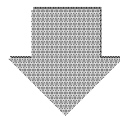

3) Failure Diagnostic Work	<ul style="list-style-type: none">• Check the resistance value of the start assist relay.• Check the harness for correct continuity. <p>*For details of the method and the procedure of diagnosis, see P.1-174</p>
----------------------------	---

(2) P1233/3: Failure B with Start Assist Relay

DTC	P1233/3	Failure B with Start Assist Relay
-----	---------	-----------------------------------

DTC Detecting Conditions

1 - Precondition; 2 - Detecting condition(s); 3 - Flashing pattern of failure indicator	Check points
1. Key switch ON. 2. Make an assessment logically as to followings.E-ECU detects the start assist relay turning OFF during the command to turn ON the start assist relay. 3. One flash followed by five flashes.	Connector Harness Start Assist Relay E-ECU

Movement at Error occurrence

Error Mode	[Run As Is]: After detecting the error, the system lets the engine continue to run without any restrictions.
Run restricted?	No.
Recovery Conditions	No.
Remarks	

Estimation of Failure cause/Error condition

- The connector may not be properly connected.
 - Wiring defect of the harness
 - The start assist relay wiring may be short-circuited with GND (*NOTE).
 - The start assist relay may be faulty.
 - Inner wiring of the start assist relay may be short-circuited with GND (*NOTE).
- *NOTE) If the start assist relay wire is short-circuited with GND, the E-ECU's power supply line fuse 10A might be blown. Also the E-ECU internal circuitry may be faulty. In this case, the E-ECU may fail to detect/indicate the error, and to store the error history.**
- The E-ECU internal circuitry may be faulty.

Diagnosis Description

1) Initial diagnosis with the diagnosis tool	<ul style="list-style-type: none">• Check the fault indication.• Check the output signal of the start assist relay.• Check the movement of the start assist relay by the active control function. <p>*For details of the method and the procedure of diagnosis, see P.1-174</p>
--	---

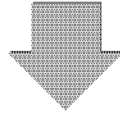

2) Check of connectors/wiring	<ul style="list-style-type: none">• Before beginning your work, be sure to turn off the key switch.• Check that the connector of the start assist relay is correctly inserted.• Check that the wiring of the start assist relay is not disconnected or the insulation of the wiring is not peeled.
-------------------------------	--

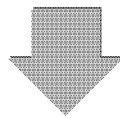

3) Failure Diagnostic Work	<ul style="list-style-type: none">• Check the resistance value of the start assist relay.• Check the harness for correct continuity. <p>*For details of the method and the procedure of diagnosis, see P.1-174</p>
----------------------------	---

(3) P1234/2: Intermittent Failure with Start Assist Relay

DTC	P1234/2	Intermittent Failure with Start Assist Relay
-----	---------	--

DTC Detecting Conditions

1 - Precondition; 2 - Detecting condition(s); 3 - Flashing pattern of failure indicator	Check points
1. Engine running. 2. Unconfirmed error detected 10 times. 3: Does not flash.	Connector Harness Start Assist Relay E-ECU

Movement at Error occurrence

Error Mode	[Run As Is]: After detecting the error, the system lets the engine continue to run without any restrictions.
Run restricted?	No.
Recovery Conditions	No.
Remarks	

Estimation of Failure cause/Error condition

- The connector may not be properly connected.
- Wiring defect of the harness
 - The start assist relay wiring may be disconnected or short-circuited with POWER SUPPLY.
- The E-ECU internal circuitry may be faulty.

Diagnosis Description

1) Initial diagnosis with the diagnosis tool	<ul style="list-style-type: none">• Check the fault indication.• Check the output signal of the start assist relay.• Check the movement of the start assist relay by the active control function. <p>*For details of the method and the procedure of diagnosis, see P.1-174</p>
--	---

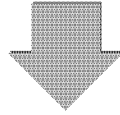

2) Check of connectors/wiring	<ul style="list-style-type: none">• Before beginning your work, be sure to turn off the key switch.• Check that the connector of the start assist relay is correctly inserted.• Check that the wiring of the start assist relay is not disconnected or the insulation of the wiring is not peeled.
-------------------------------	--

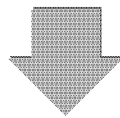

3) Failure Diagnostic Work	<ul style="list-style-type: none">• Check the resistance value of the start assist relay.• Check the harness for correct continuity. <p>*For details of the method and the procedure of diagnosis, see P.1-174</p>
----------------------------	---

CSD solenoid valve

(1) P1242/4: Failure A with CSD solenoid valve

DTC	P1242/4	Failure A with CSD Solenoid Valve
-----	---------	-----------------------------------

DTC Detecting Conditions

1 - Precondition; 2 - Detecting condition(s); 3 - Flashing pattern of failure indicator	Check points
1. Key switch ON. 2. Make an assessment logically as to followings. E-ECU detects the CSD solenoid valve turning ON signal during the command to turn OFF the CSD solenoid valve. 3. One flash followed by four flashes.	Connector Harness CSD solenoid valve E-ECU

Movement at Error occurrence

Error Mode	[Run As Is]: After detecting the error, the system lets the engine continue to run without any restrictions.
Run restricted?	No.
Recovery Conditions	No.
Remarks	

Estimation of Failure cause/Error condition

- The connector may not be properly connected.
- Wiring defect of the harness
 - CSD solenoid valve wiring may be disconnected or short-circuited with POWER SUPPLY.
- The CSD solenoid valve may be faulty.
 - Inner wiring disconnection
- The E-ECU internal circuitry may be faulty.

Diagnosis Description

1) Initial diagnosis with the diagnosis tool	<ul style="list-style-type: none">• Check the fault indication.• Check the output signal of the CSD solenoid valve.• Check the movement of the CSD solenoid valve by the active control function. <p>*For details of the method and the procedure of diagnosis, see P.1-178</p>
--	---

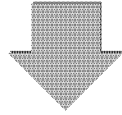

2) Check of connectors/wiring	<ul style="list-style-type: none">• Before beginning your work, be sure to turn off the key switch.• Check that the connector of the CSD solenoid valve is correctly inserted.• Check that the wiring of the CSD solenoid valve is not disconnected or the insulation of the wiring is not peeled.
-------------------------------	--

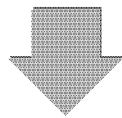

3) Failure Diagnostic Work	<ul style="list-style-type: none">• Check the resistance value of the CSD solenoid valve coil.• Check the harness for correct continuity. <p>*For details of the method and the procedure of diagnosis, see P.1-178</p>
----------------------------	--

(2) P1243/3: Failure B with CSD solenoid valve

DTC	P1243/3	Failure B with CSD Solenoid Valve
-----	---------	-----------------------------------

DTC Detecting Conditions

1 - Precondition; 2 - Detecting condition(s); 3 - Flashing pattern of failure indicator	Check points
1. Key switch ON. 2. Make an assessment logically as to followings. E-ECU detects the CSD solenoid valve turning OFF signal during the command to turn ON the CSD solenoid valve. 3. One flash followed by four flashes.	Connector Harness CSD solenoid valve E-ECU

Movement at Error occurrence

Error Mode	[Run As Is]: After detecting the error, the system lets the engine continue to run without any restrictions.
Run restricted?	No.
Recovery Conditions	No.
Remarks	

Estimation of Failure cause/Error condition

- The connector may not be properly connected.
 - Wiring defect of the harness
 - The CSD solenoid valve wiring may be short-circuited with GND (*NOTE).
 - The CSD solenoid valve may be faulty.
 - Inner wiring short-circuited with GND (*NOTE).
- *NOTE) If the CSD solenoid valve wire is short-circuited with GND, the E-ECU's power supply line fuse 10A might be blown. Also the E-ECU internal circuitry may be faulty. In this case, the E-ECU may fail to detect/indicate the error, and to store the error history.**
- The E-ECU internal circuitry may be faulty.

Diagnosis Description

1) Initial diagnosis with the diagnosis tool	<ul style="list-style-type: none">• Check the fault indication.• Check the output signal of the CSD solenoid valve.• Check the movement of the CSD solenoid valve by the active control function. <p>*For details of the method and the procedure of diagnosis, see P.1-178</p>
--	---

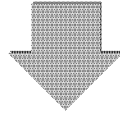

2) Check of connectors/wiring	<ul style="list-style-type: none">• Before beginning your work, be sure to turn off the key switch.• Check that the connector of the CSD solenoid valve is correctly inserted.• Check that the wiring of the CSD solenoid valve is not disconnected or the insulation of the wiring is not peeled.
-------------------------------	--

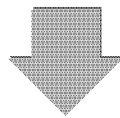

3) Failure Diagnostic Work	<ul style="list-style-type: none">• Check the resistance value of the CSD solenoid valve coil.• Check the harness for correct continuity. <p>*For details of the method and the procedure of diagnosis, see P.1-178</p>
----------------------------	--

(3) P1244/2: Intermittent Failure with CSD solenoid valve

DTC	P1244/2	Intermittent Failure with CSD solenoid valve
-----	---------	--

DTC Detecting Conditions

1 - Precondition; 2 - Detecting condition(s); 3 - Flashing pattern of failure indicator	Check points
1. Engine running. 2. Unconfirmed error detected 10 times. 3: Does not flash.	Connector Harness CSD solenoid valve E-ECU

Movement at Error occurrence

Error Mode	[Run As Is]: After detecting the error, the system lets the engine continue to run without any restrictions.
Run restricted?	No.
Recovery Conditions	No.
Remarks	

Estimation of Failure cause/Error condition

- The connector may not be properly connected.
- Wiring defect of the harness
 - The CSD solenoid valve wiring may be disconnected or short-circuited with POWER SUPPLY.
- The E-ECU internal circuitry may be faulty.

Diagnosis Description

1) Initial diagnosis with the diagnosis tool	<ul style="list-style-type: none">• Check the fault indication.• Check the output signal of the CSD solenoid valve.• Check the movement of the CSD solenoid valve by the active control function. <p>*For details of the method and the procedure of diagnosis, see P.1-178</p>
--	---

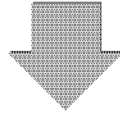

2) Check of connectors/wiring	<ul style="list-style-type: none">• Before beginning your work, be sure to turn off the key switch.• Check that the connector of the CSD solenoid valve is correctly inserted.• Check that the wiring of the CSD solenoid valve is not disconnected or the insulation of the wiring is not peeled.
-------------------------------	--

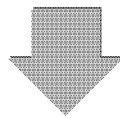

3) Failure Diagnostic Work	<ul style="list-style-type: none">• Check the resistance value of the CSD solenoid valve coil.• Check the harness for correct continuity. <p>*For details of the method and the procedure of diagnosis, see P.1-178</p>
----------------------------	--

EGR valve

(1) P1402/4: Failure A with EGR valve (Step Motor A-phase)

DTC	P1402/4	Failure A with EGR valve (Step Motor A-Phase)
------------	----------------	--

DTC Detecting Conditions

1 - Precondition; 2 - Detecting condition(s); 3 - Flashing pattern of failure indicator	Check points
1. Key switch ON. 2. Make an assessment logically as to followings.E-ECU detects the EGR step motor A-phase turning ON during the command to turn OFF the EGR step motor A-phase. 3. One flash followed by three flashes.	Connector Harness EGR valve (step motor) E-ECU

Movement at Error occurrence

	Movement setting at the EGR step motor error	
	Unavailable	Available
Error Mode	[Run As Is]: After detecting the error, the system lets the engine continue to run without any restrictions.	[Run Under Restrictions]: The engine continues to run under restrictions.
Run restricted?	No.	Yes: The system restricts the High idle speed or engine power.
Recovery Conditions	No.	No.
Remarks		

Estimation of Failure cause/Error condition

- The connector may not be properly connected.
- Wiring defect of the harness
 - The EGR step motor A-phase wiring may be disconnected or short-circuited with GND.
 - The EGR step motor power supply line may be disconnected.
- The EGR step motor may be faulty.
 - Inner wiring of the EGR step motor A-phase may be disconnected or short-circuited with GND.
 - Power supply line in the EGR step motor may be disconnected.
- The E-ECU internal circuitry may be faulty.

Diagnosis Description

1) Initial diagnosis with the diagnosis tool	<ul style="list-style-type: none">• Check the fault indication.• Check the output signal of the EGR step motor.• Check the movement of the EGR step motor by the active control function. <p>*For details of the method and the procedure of diagnosis, see P.1-182</p>
--	---

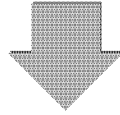

2) Check of connectors/wiring	<ul style="list-style-type: none">• Before beginning your work, be sure to turn off the key switch.• Check that the connector of the EGR step motor is correctly inserted.• Check that the wiring of the EGR step motor is not disconnected or the insulation of the wiring is not peeled.
-------------------------------	--

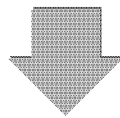

3) Failure Diagnostic Work	<ul style="list-style-type: none">• Check the coil resistance of the EGR step motor.• Check the harness for correct continuity. <p>*For details of the method and the procedure of diagnosis, see P.1-182</p>
----------------------------	--

(2) P1403/3: Failure B with EGR valve (Step Motor A-phase)

DTC	P1403/3	Failure B with EGR valve (Step Motor A-Phase)
------------	----------------	--

DTC Detecting Conditions

1 - Precondition; 2 - Detecting condition(s); 3 - Flashing pattern of failure indicator	Check points
1. Key switch ON. 2. Make an assessment logically as to followings.E-ECU detects the EGR step motor A-phase turning OFF during the command to turn ON the EGR step motor A-phase. 3. One flash followed by three flashes.	Connector Harness EGR valve (step motor) E-ECU

Movement at Error occurrence

	Movement setting at the EGR step motor error	
	Unavailable	Available
Error Mode	[Run As Is]: After detecting the error, the system lets the engine continue to run without any restrictions.	[Run Under Restrictions]: The engine continues to run under restrictions.
Run restricted?	No.	Yes: The system restricts the High idle speed or engine power.
Recovery Conditions	No.	No.
Remarks		

Estimation of Failure cause/Error condition

- The connector may not be properly connected.
- Wiring defect of the harness
 - The EGR step motor A-phase wiring may be short-circuited with POWER SUPPLY.
 - The EGR step motor wiring may be short-circuited between phases.
- The EGR step motor may be faulty.
 - Inner wiring of the EGR step motor A-phase may be short-circuited with POWER SUPPLY.
 - Inner wiring of the EGR step motor may be short-circuited between phases.
- The E-ECU internal circuitry may be faulty.

Diagnosis Description

1) Initial diagnosis
with the diagnosis
tool

- Check the fault indication.
- Check the output signal of the EGR step motor.
- Check the movement of the EGR step motor by the active control function.

*For details of the method and the procedure of diagnosis, see P.1-182

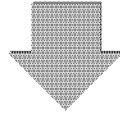

2) Check of
connectors/wiring

- Before beginning your work, be sure to turn off the key switch.
- Check that the connector of the EGR step motor is correctly inserted.
- Check that the wiring of the EGR step motor is not disconnected or the insulation of the wiring is not peeled.

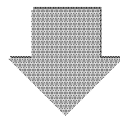

3) Failure Diagnostic
Work

- Check the coil resistance of the EGR step motor.
- Check the harness for correct continuity.

*For details of the method and the procedure of diagnosis, see P.1-182

(3) P1412/4: Failure A with EGR valve (Step Motor B-phase)

DTC	P1412/4	Failure A with EGR valve (Step Motor B-Phase)
------------	----------------	--

DTC Detecting Conditions

1 - Precondition; 2 - Detecting condition(s); 3 - Flashing pattern of failure indicator	Check points
1. Key switch ON. 2. Make an assessment logically as to followings.E-ECU detects the EGR step motor B-phase turning ON during the command to turn OFF the EGR step motor B-phase. 3. One flash followed by three flashes.	Connector Harness EGR valve (step motor) E-ECU

Movement at Error occurrence

	Movement setting at the EGR step motor error	
	Unavailable	Available
Error Mode	[Run As Is]: After detecting the error, the system lets the engine continue to run without any restrictions.	[Run Under Restrictions]: The engine continues to run under restrictions.
Run restricted?	No.	Yes: The system restricts the High idle speed or engine power.
Recovery Conditions	No.	No.
Remarks		

Estimation of Failure cause/Error condition

- The connector may not be properly connected.
- Wiring defect of the harness
 - The EGR step motor B-phase wiring may be disconnected or short-circuited with GND.
 - The EGR step motor power supply line may be disconnected.
- The EGR step motor may be faulty.
 - Inner wiring of the EGR step motor B-phase may be disconnected or short-circuited with GND.
 - Power supply line in the EGR step motor may be disconnected.
- The E-ECU internal circuitry may be faulty.

Diagnosis Description

1) Initial diagnosis with the diagnosis tool	<ul style="list-style-type: none">• Check the fault indication.• Check the output signal of the EGR step motor.• Check the movement of the EGR step motor by the active control function. <p>*For details of the method and the procedure of diagnosis, see P.1-182</p>
--	---

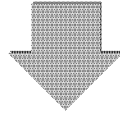

2) Check of connectors/wiring	<ul style="list-style-type: none">• Before beginning your work, be sure to turn off the key switch.• Check that the connector of the EGR step motor is correctly inserted.• Check that the wiring of the EGR step motor is not disconnected or the insulation of the wiring is not peeled.
-------------------------------	--

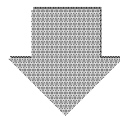

3) Failure Diagnostic Work	<ul style="list-style-type: none">• Check the coil resistance of the EGR step motor.• Check the harness for correct continuity. <p>*For details of the method and the procedure of diagnosis, see P.1-182</p>
----------------------------	--

(4) P1413/3: Failure B with EGR valve (Step Motor B-phase)

DTC	P1413/3	Failure B with EGR valve (Step Motor B-Phase)
------------	----------------	--

DTC Detecting Conditions

1 - Precondition; 2 - Detecting condition(s); 3 - Flashing pattern of failure indicator	Check points
1. Key switch ON. 2. Make an assessment logically as to followings.E-ECU detects the EGR step motor B-phase turning OFF during the command to turn ON the EGR step motor B-phase. 3. One flash followed by three flashes.	Connector Harness EGR valve (step motor) E-ECU

Movement at Error occurrence

	Movement setting at the EGR step motor error	
	Unavailable	Available
Error Mode	[Run As Is]: After detecting the error, the system lets the engine continue to run without any restrictions.	[Run Under Restrictions]: The engine continues to run under restrictions.
Run restricted?	No.	Yes: The system restricts the High idle speed or engine power.
Recovery Conditions	No.	No.
Remarks		

Estimation of Failure cause/Error condition

- The connector may not be properly connected.
- Wiring defect of the harness
 - The EGR step motor B-phase wiring may be short-circuited with POWER SUPPLY.
 - The EGR step motor wiring may be short-circuited between phases.
- The EGR step motor may be faulty.
 - Inner wiring of the EGR step motor B-phase may be short-circuited with POWER SUPPLY.
 - Inner wiring of the EGR step motor may be short-circuited between phases.
- The E-ECU internal circuitry may be faulty.

Diagnosis Description

- | | |
|--|---|
| 1) Initial diagnosis with the diagnosis tool | <ul style="list-style-type: none">• Check the fault indication.• Check the output signal of the EGR step motor.• Check the movement of the EGR step motor by the active control function. |
|--|---|

*For details of the method and the procedure of diagnosis, see P.1-182

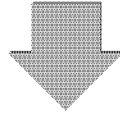

- | | |
|-------------------------------|--|
| 2) Check of connectors/wiring | <ul style="list-style-type: none">• Before beginning your work, be sure to turn off the key switch.• Check that the connector of the EGR step motor is correctly inserted.• Check that the wiring of the EGR step motor is not disconnected or the insulation of the wiring is not peeled. |
|-------------------------------|--|

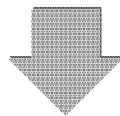

- | | |
|----------------------------|--|
| 3) Failure Diagnostic Work | <ul style="list-style-type: none">• Check the coil resistance of the EGR step motor.• Check the harness for correct continuity. |
|----------------------------|--|

*For details of the method and the procedure of diagnosis, see P.1-182

(5) P1422/4: Failure A with EGR valve (Step Motor C-phase)

DTC	P1422/4	Failure A with EGR valve (Step Motor C-Phase)
------------	----------------	--

DTC Detecting Conditions

1 - Precondition; 2 - Detecting condition(s); 3 - Flashing pattern of failure indicator	Check points
1. Key switch ON. 2. Make an assessment logically as to followings.E-ECU detects the EGR step motor C-phase turning ON during the command to turn OFF the EGR step motor C-phase. 3. One flash followed by three flashes.	Connector Harness EGR valve (step motor) E-ECU

Movement at Error occurrence

	Movement setting at the EGR step motor error	
	Unavailable	Available
Error Mode	[Run As Is]: After detecting the error, the system lets the engine continue to run without any restrictions.	[Run Under Restrictions]: The engine continues to run under restrictions.
Run restricted?	No.	Yes: The system restricts the High idle speed or engine power.
Recovery Conditions	No.	No.
Remarks		

Estimation of Failure cause/Error condition

- The connector may not be properly connected.
- Wiring defect of the harness
 - The EGR step motor C-phase wiring may be disconnected or short-circuited with GND.
 - The EGR step motor power supply line may be disconnected.
- The EGR step motor may be faulty.
 - Inner wiring of the EGR step motor C-phase may be disconnected or short-circuited with GND.
 - Power supply line in the EGR step motor may be disconnected.
- The E-ECU internal circuitry may be faulty.

Diagnosis Description

- | | |
|--|---|
| 1) Initial diagnosis with the diagnosis tool | <ul style="list-style-type: none">• Check the fault indication.• Check the output signal of the EGR step motor.• Check the movement of the EGR step motor by the active control function. |
|--|---|

*For details of the method and the procedure of diagnosis, see P.1-182

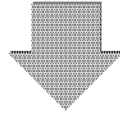

- | | |
|-------------------------------|--|
| 2) Check of connectors/wiring | <ul style="list-style-type: none">• Before beginning your work, be sure to turn off the key switch.• Check that the connector of the EGR step motor is correctly inserted.• Check that the wiring of the EGR step motor is not disconnected or the insulation of the wiring is not peeled. |
|-------------------------------|--|

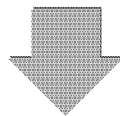

- | | |
|----------------------------|--|
| 3) Failure Diagnostic Work | <ul style="list-style-type: none">• Check the coil resistance of the EGR step motor.• Check the harness for correct continuity. |
|----------------------------|--|

*For details of the method and the procedure of diagnosis, see P.1-182

(6) P1423/3: Failure B with EGR valve (Step Motor C-phase)

DTC	P1423/3	Failure B with EGR valve (Step Motor C-Phase)
------------	----------------	--

DTC Detecting Conditions

1 - Precondition; 2 - Detecting condition(s); 3 - Flashing pattern of failure indicator	Check points
1. Key switch ON. 2. Make an assessment logically as to followings.E-ECU detects the EGR step motor C-phase turning OFF during the command to turn ON the EGR step motor C-phase. 3. One flash followed by three flashes.	Connector Harness EGR valve (step motor) E-ECU

Movement at Error occurrence

	Movement setting at the EGR step motor error	
	Unavailable	Available
Error Mode	[Run As Is]: After detecting the error, the system lets the engine continue to run without any restrictions.	[Run Under Restrictions]: The engine continues to run under restrictions.
Run restricted?	No.	Yes: The system restricts the High idle speed or engine power.
Recovery Conditions	No.	No.
Remarks		

Estimation of Failure cause/Error condition

- The connector may not be properly connected.
- Wiring defect of the harness
 - The EGR step motor C-phase wiring may be short-circuited with POWER SUPPLY.
 - The EGR step motor wiring may be short-circuited between phases.
- The EGR step motor may be faulty.
 - Inner wiring of the EGR step motor C-phase may be short-circuited with POWER SUPPLY.
 - Inner wiring of the EGR step motor may be short-circuited between phases.
- The E-ECU internal circuitry may be faulty.

Diagnosis Description

- | | |
|--|---|
| 1) Initial diagnosis with the diagnosis tool | <ul style="list-style-type: none">• Check the fault indication.• Check the output signal of the EGR step motor.• Check the movement of the EGR step motor by the active control function. |
|--|---|

*For details of the method and the procedure of diagnosis, see P.1-182

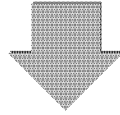

- | | |
|-------------------------------|--|
| 2) Check of connectors/wiring | <ul style="list-style-type: none">• Before beginning your work, be sure to turn off the key switch.• Check that the connector of the EGR step motor is correctly inserted.• Check that the wiring of the EGR step motor is not disconnected or the insulation of the wiring is not peeled. |
|-------------------------------|--|

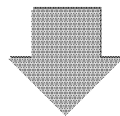

- | | |
|----------------------------|--|
| 3) Failure Diagnostic Work | <ul style="list-style-type: none">• Check the coil resistance of the EGR step motor.• Check the harness for correct continuity. |
|----------------------------|--|

*For details of the method and the procedure of diagnosis, see P.1-182

(7) P1432/4: Failure A with EGR valve (Step Motor D-phase)

DTC	P1432/4	Failure A with EGR valve (Step Motor D-Phase)
------------	----------------	--

DTC Detecting Conditions

1 - Precondition; 2 - Detecting condition(s); 3 - Flashing pattern of failure indicator	Check points
1. Key switch ON. 2. Make an assessment logically as to followings. E-ECU detects the EGR step motor D-phase turning ON during the command to turn OFF the EGR step motor C-phase. 3. One flash followed by three flashes.	Connector Harness EGR valve (step motor) E-ECU

Movement at Error occurrence

	Movement setting at the EGR step motor error	
	Unavailable	Available
Error Mode	[Run As Is]: After detecting the error, the system lets the engine continue to run without any restrictions.	[Run Under Restrictions]: The engine continues to run under restrictions.
Run restricted?	No.	Yes: The system restricts the High idle speed or engine power.
Recovery Conditions	No.	No.
Remarks		

Estimation of Failure cause/Error condition

- The connector may not be properly connected.
- Wiring defect of the harness
 - The EGR step motor D-phase wiring may be disconnected or short-circuited with GND.
 - The EGR step motor power supply line may be disconnected.
- The EGR step motor may be faulty.
 - Inner wiring of the EGR step motor D-phase may be disconnected or short-circuited with GND.
 - Power supply line in the EGR step motor may be disconnected.
- The E-ECU internal circuitry may be faulty.

Diagnosis Description

1) Initial diagnosis with the diagnosis tool	<ul style="list-style-type: none">• Check the fault indication.• Check the output signal of the EGR step motor.• Check the movement of the EGR step motor by the active control function. <p>*For details of the method and the procedure of diagnosis, see P.1-182</p>
--	---

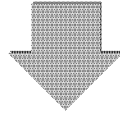

2) Check of connectors/wiring	<ul style="list-style-type: none">• Before beginning your work, be sure to turn off the key switch.• Check that the connector of the EGR step motor is correctly inserted.• Check that the wiring of the EGR step motor is not disconnected or the insulation of the wiring is not peeled.
-------------------------------	--

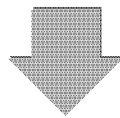

3) Failure Diagnostic Work	<ul style="list-style-type: none">• Check the coil resistance of the EGR step motor.• Check the harness for correct continuity. <p>*For details of the method and the procedure of diagnosis, see P.1-182</p>
----------------------------	--

(8) P1433/3: Failure B with EGR valve (Step Motor D-phase)

DTC	P1433/3	Failure B with EGR valve (Step Motor D-Phase)
------------	----------------	--

DTC Detecting Conditions

1 - Precondition; 2 - Detecting condition(s); 3 - Flashing pattern of failure indicator	Check points
1. Key switch ON. 2. Make an assessment logically as to followings.E-ECU detects the EGR step motor D-phase turning OFF during the command to turn ON the EGR step motor D-phase. 3. One flash followed by three flashes.	Connector Harness EGR valve (step motor) E-ECU

Movement at Error occurrence

	Movement setting at the EGR step motor error	
	Unavailable	Available
Error Mode	[Run As Is]: After detecting the error, the system lets the engine continue to run without any restrictions.	[Run Under Restrictions]: The engine continues to run under restrictions.
Run restricted?	No.	Yes: The system restricts the High idle speed or engine power.
Recovery Conditions	No.	No.
Remarks		

Estimation of Failure cause/Error condition

- The connector may not be properly connected.
- Wiring defect of the harness
 - The EGR step motor D-phase wiring may be short-circuited with POWER SUPPLY.
 - The EGR step motor wiring may be short-circuited between phases.
- The EGR step motor may be faulty.
 - Inner wiring of the EGR step motor D-phase may be short-circuited with POWER SUPPLY.
 - Inner wiring of the EGR step motor may be short-circuited between phases.
- The E-ECU internal circuitry may be faulty.

Diagnosis Description

1) Initial diagnosis
with the diagnosis
tool

- Check the fault indication.
- Check the output signal of the EGR step motor.
- Check the movement of the EGR step motor by the active control function.

*For details of the method and the procedure of diagnosis, see P.1-182

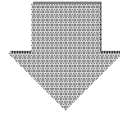

2) Check of
connectors/wiring

- Before beginning your work, be sure to turn off the key switch.
- Check that the connector of the EGR step motor is correctly inserted.
- Check that the wiring of the EGR step motor is not disconnected or the insulation of the wiring is not peeled.

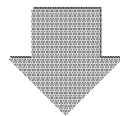

3) Failure Diagnostic
Work

- Check the coil resistance of the EGR step motor.
- Check the harness for correct continuity.

*For details of the method and the procedure of diagnosis, see P.1-182

Contact Input Related Failures

Oil Pressure Related Failures

(1) P1192/4: Failure with Oil Pressure Switch

DTC	P1192/4	Failure with oil pressure switch
------------	----------------	---

DTC Detecting Conditions

1 - Precondition; 2 - Detecting condition(s); 3 - Flashing pattern of failure indicator	Check points
1. Key switch ON. 2. Oil pressure switch turns ON with engine stopped. * This manual assumes that the contact input is configured as Normally Open (NO). 3. Two flashes followed by one flash.	Connector Harness Oil pressure switch E-ECU

Movement at Error occurrence

Error Mode	[Run As Is]: After detecting the error, the system lets the engine continue to run without any restrictions.
Run restricted?	No.
Recovery Conditions	No.
Remarks	

Estimation of Failure cause/Error condition

- The connector may not be properly connected.
- Wiring defect of the harness
 - The oil pressure switch wiring may be disconnected or short-circuited with POWER SUPPLY.
- The oil pressure switch may be faulty.
 - Inner wiring of the oil pressure switch may be disconnected or short-circuited with POWER SUPPLY.
- The E-ECU internal circuitry may be faulty.

Diagnosis Description

1) Initial diagnosis with the diagnosis tool	<ul style="list-style-type: none">• Check the fault indication.• Check that the input signal of the oil pressure switch is correctly recognized. <p>*For details of the method and the procedure of diagnosis, see P.1-187</p>
--	---

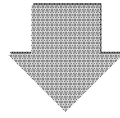

2) Check of connectors/wiring	<ul style="list-style-type: none">• Before beginning your work, be sure to turn off the key switch.• Check that the connector of the oil pressure switch is correctly inserted.• Check that the wiring of the oil pressure switch is not disconnected or the insulation of the wiring is not peeled.
-------------------------------	--

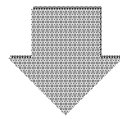

3) Failure Diagnostic Work	<ul style="list-style-type: none">• Check the harness for correct continuity. <p>*For details of the method and the procedure of diagnosis, see P.1-187</p>
----------------------------	---

(2) P1198/1: Abnormal Oil Pressure Descend

DTC	P1198/1	Abnormal Oil Pressure Descend
------------	----------------	--------------------------------------

DTC Detecting Conditions

1 - Precondition; 2 - Detecting condition(s); 3 - Flashing pattern of failure indicator	Check points
1. Key switch ON. 2. Oil pressure switch turns ON after engine has been started. * This manual assumes that the contact input is configured as Normally Open (NO). 3. Three flashes followed by one flash	Hydrostatic system Harness Oil pressure switch E-ECU

Movement at Error occurrence

	Setting of response to "oil pressure low" alarm	
	Unavailable	Available
Error Mode	[Run As Is]: After detecting the error, the system lets the engine continue to run without any restrictions.	[Run Under Restrictions]: The engine continues to run under restrictions.
Run restricted?	No.	Yes: The system restricts the High idle speed or engine power.
Recovery Conditions	No.	No.
Remarks		

Estimation of Failure cause/Error condition

- The oil pressure may be too low.
- The hydraulic system may be faulty.
- Wiring defect of the harness
 - The oil pressure switch wiring may be short-circuited with GND.
- The oil pressure switch may be faulty.
 - Inner wiring of the oil pressure switch may be short-circuited with GND.
- The E-ECU internal circuitry may be faulty.

Diagnosis Description

1) Initial diagnosis with the diagnosis tool	<ul style="list-style-type: none">• Check the fault indication.• Check that the input signal of the oil pressure switch is correctly recognized. <p>*For details of the method and the procedure of diagnosis, see P.1-187</p>
--	---

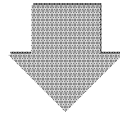

2) Engine Inspection	<ul style="list-style-type: none">• Turn the key switch off to stop the engine.• Inspect the oil pressure system.• After the inspection, turn the key switch on to check if the DTC is detected. <p>*For description and procedure of engine inspection, see the Service manual ("Engine").</p>
----------------------	---

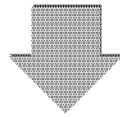

3) Failure Diagnostic Work	<ul style="list-style-type: none">• Check the oil pressure switch system. <p>*For details of the method and the procedure of diagnosis, see P.1-187</p>
----------------------------	---

Battery Charge Related Failures

(1) P1562/4: Failure with Charge Switch

DTC	P1562/4	Failure with Charge Switch
-----	---------	----------------------------

DTC Detecting Conditions

1 - Precondition; 2 - Detecting condition(s); 3 - Flashing pattern of failure indicator	Check points
1. Key switch ON. 2. Charge switch turns OFF with engine stopped. * This manual assumes that the contact input is configured as Normally Open (NO). 3. Two flashes followed by two flashes.	Connector Harness Charge switch E-ECU

Movement at Error occurrence

Error Mode	[Run As Is]: After detecting the error, the system lets the engine continue to run without any restrictions.
Run restricted?	No.
Recovery Conditions	No.
Remarks	

Estimation of Failure cause/Error condition

- The connector may not be properly connected.
- Wiring defect of the harness
 - The charge switch wiring may be disconnected or short-circuited with POWER SUPPLY.
- The charge switch may be faulty.
 - Inner wiring of the charge switch may be disconnected or short-circuited with POWER SUPPLY.
- The E-ECU internal circuitry may be faulty.

Diagnosis Description

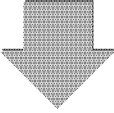
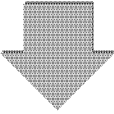
1) Initial diagnosis with the diagnosis tool	<ul style="list-style-type: none">• Check the fault indication.• Check that the input signal of the charge switch is correctly recognized. <p>*For details of the method and the procedure of diagnosis, see P.1-187</p>
	
2) Check of connectors/wiring	<ul style="list-style-type: none">• Before beginning your work, be sure to turn off the key switch.• Check that the connector of the charge switch is correctly inserted.• Check that the wiring of the charge switch is not disconnected or the insulation of the wiring is not peeled.
	
3) Failure Diagnostic Work	<ul style="list-style-type: none">• Check the harness for correct continuity. <p>*For details of the method and the procedure of diagnosis, see P.1-187</p>

(2) P1568/1: Charge Alarm

DTC	P1568/1	Charge Alarm
------------	----------------	---------------------

DTC Detecting Conditions

1 - Precondition; 2 - Detecting condition(s); 3 - Flashing pattern of failure indicator	Check points
1. Key switch ON. 2. Charge switch turns ON after engine has been started. * This manual assumes that the contact input is configured as Normally Open (NO). 3. Three flashes followed by two flashes.	alternator Harness Charge switch E-ECU

Movement at Error occurrence

Error Mode	[Run As Is]: After detecting the error, the system lets the engine continue to run without any restrictions.
Run restricted?	No.
Recovery Conditions	No.
Remarks	

Estimation of Failure cause/Error condition

- The battery may not be properly charged.
- The alternator may be faulty.
- Wiring defect of the harness
 - The charge switch wiring may be short-circuited with GND.
- The charge switch may be faulty.
 - Inner wiring of the charge switch may be short-circuited with GND.
- The E-ECU internal circuitry may be faulty.

Diagnosis Description

1) Initial diagnosis
with the diagnosis
tool

- Check the fault indication.
- Check that the input signal of the charge switch is correctly recognized.

*For details of the method and the procedure of diagnosis, see P.1-187

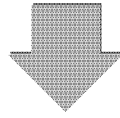

2) Engine Inspection

- Turn the key switch off to stop the engine.
- Inspect the charging system of the engine .
- After the inspection, turn the key switch on to check if the DTC is detected.

*For description and procedure of engine inspection, see the Service manual ("Engine").

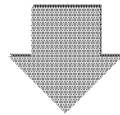

3) Failure Diagnostic
Work

- Check the charge switch system.

*For details of the method and the procedure of diagnosis, see P.1-187

Water Temperature Switch

(1) P1217/0: Abnormal Water Temperature

DTC	P1217/0	Abnormal Water Temperature
------------	----------------	-----------------------------------

DTC Detecting Conditions

1 - Precondition; 2 - Detecting condition(s); 3 - Flashing pattern of failure indicator	Check points
1. Key switch ON. 2. Water temperature switch turns ON after engine has been started. * This manual assumes that the contact input is configured as Normally Open (NO). 3. Three flashes followed by three flashes.	Engine cooling system Harness Water Temperature Switch E-ECU

Movement at Error occurrence

	Setting of response to water temperature error	
	Unavailable	Available
Error Mode	[Run As Is]: After detecting the error, the system lets the engine continue to run without any restrictions.	[Run Under Restrictions]: The engine continues to run under restrictions.
Run restricted?	No.	Yes: The system restricts the High idle speed or engine power.
Recovery Conditions	No.	No.
Remarks		

Estimation of Failure cause/Error condition

- The engine may be overheated.
- The engine cooling water level may be too low.
- The engine cooling system may be faulty.
- Wiring defect of the harness
 - The water temperature switch wiring may be short-circuited with GND.
- The water temperature switch may be faulty.
 - Inner wiring of the water temperature switch may be short-circuited with GND.
- The E-ECU internal circuitry may be faulty.

Diagnosis Description

1) Initial diagnosis
with the diagnosis
tool

- Check the fault indication.
- Check that the input signal of the water temperature switch is correctly recognized.

*For details of the method and the procedure of diagnosis, see P.1-187

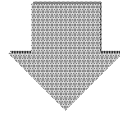

2) Engine Inspection

- Turn the key switch off to stop the engine.
- Check the engine cooling system.
- After a little, turn the key switch on to check if the DTC is detected.

*For description and procedure of engine inspection, see the Service manual ("Engine").

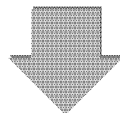

3) Failure Diagnostic
Work

- Check the water temperature switch system.

*For details of the method and the procedure of diagnosis, see P.1-187

Air cleaner switch

(1) P1101/0: Air Cleaner Clogging Alarm

DTC	P1101/0	Air cleaner Clogging Alarm
------------	---------	----------------------------

DTC Detecting Conditions

1 - Precondition; 2 - Detecting condition(s); 3 - Flashing pattern of failure indicator	Check points
1. Key switch ON. 2. Air cleaner switch turns ON after engine has been started. * This manual assumes that the contact input is configured as Normally Open (NO). 3. Three flashes followed by four flashes.	Air Cleaner Harness Air cleaner switch E-ECU

Movement at Error occurrence

	Setting of Response to Air Cleaner Failure	
	Unavailable	Available
Error Mode	[Run As Is]: After detecting the error, the system lets the engine continue to run without any restrictions.	[Run Under Restrictions]: The engine continues to run under restrictions.
Run restricted?	No.	Yes: The system restricts the High idle speed or engine power.
Recovery Conditions	No.	No.
Remarks		

Estimation of Failure cause/Error condition

- The air cleaner may be clogged.
- Wiring defect of the harness
 - The air cleaner switch wiring may be short-circuited with GND.
- The air cleaner switch may be faulty.
 - Inner wiring of the air cleaner switch may be short-circuited with GND.
- The E-ECU internal circuitry may be faulty.

Diagnosis Description

1) Initial diagnosis with the diagnosis tool	<ul style="list-style-type: none">• Check the fault indication.• Check that the input signal of the air cleaner switch is correctly recognized. <p>*For details of the method and the procedure of diagnosis, see P.1-187</p>
--	--

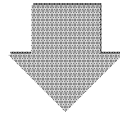

2) Engine Inspection	<ul style="list-style-type: none">• Turn the key switch off to stop the engine.• Inspect the air cleaner.• After a little, turn the key switch on to check if the DTC is detected. <p>*For description and procedure of engine inspection, see the Service manual ("Engine").</p>
----------------------	---

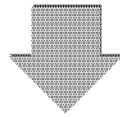

3) Failure Diagnostic Work	<ul style="list-style-type: none">• Check the air cleaner switch system. <p>*For details of the method and the procedure of diagnosis, see P.1-187</p>
----------------------------	--

Oil-Water Separator Switch

(1) P1151/0: Oil-Water Separator Alarm

DTC	P1151/0	Oil-water separator Alarm
------------	----------------	----------------------------------

DTC Detecting Conditions

1 - Precondition; 2 - Detecting condition(s); 3 - Flashing pattern of failure indicator	Check points
1. Key switch ON. 2. Oil-water separator switch turns ON after engine has been started. * This manual assumes that the contact input is configured as Normally Open (NO). 3. Three flashes followed by five flashes.	Oil-Water Separator Harness Oil-Water Separator Switch E-ECU

Movement at Error occurrence

	Setting of response to oil-water separator failure	
	Unavailable	Available
Error Mode	[Run As Is]: After detecting the error, the system lets the engine continue to run without any restrictions.	[Run Under Restrictions]: The engine continues to run under restrictions.
Run restricted?	No.	Yes: The system restricts the High idle speed or engine power.
Recovery Conditions	No.	No.
Remarks		

Estimation of Failure cause/Error condition

- The oil-water separator may be malfunctioning.
- Wiring defect of the harness
 - The oil-water separator switch wiring may be short-circuited with GND.
- The oil-water separator switch may be faulty.
 - Inner wiring of the oil-water separator switch may be short-circuited with GND.
- The E-ECU internal circuitry may be faulty.

Diagnosis Description

1) Initial diagnosis
with the diagnosis
tool

- Check the fault indication.
- Check that the input signal of the oil-water separator switch is correctly recognized.

*For details of the method and the procedure of diagnosis, see P.1-187

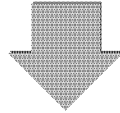

2) Engine Inspection

- Turn the key switch off to stop the engine.
- Inspect the oil-water separator.
- After a little, turn the key switch on to check if the DTC is detected.

*For description and procedure of engine inspection, see the Service manual ("Engine").

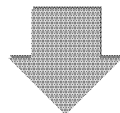

3) Failure Diagnostic
Work

- Check the oil-water separator switch system.

*For details of the method and the procedure of diagnosis, see P.1-187

Actuators etc.**Rack actuator****(1) P1212/4: Failure with Rack Actuator (Low Current)**

DTC	P1212/4	Failure with Rack Actuator (Low Current)
------------	----------------	---

DTC Detecting Conditions

1 - Precondition; 2 - Detecting condition(s); 3 - Flashing pattern of failure indicator	Check points
1. Key switch ON. 2. Rack actuator current detected equal to or below the lower limit. 3. Eight flashes.	Connector Harness Rack actuator E-ECU

Movement at Error occurrence

Error Mode	[Stop Immediately]: The engine stops running.
Run restricted?	Yes: The rack actuator relay is turned OFF, and the rack position is forcibly set to the engine stop position.
Recovery Conditions	No.
Remarks	

Estimation of Failure cause/Error condition

- The connector may not be properly connected.
- Wiring defect of the harness
 - The rack actuator wiring may be disconnected or short-circuited with GND.
- The rack actuator may be faulty.
 - Disconnection of Rack Actuator inner wiring
 - Inner wiring of the rack actuator may be short-circuited with GND.
- The E-ECU internal circuitry may be faulty.

Diagnosis Description

1) Initial diagnosis with the diagnosis tool	<ul style="list-style-type: none">• Check the fault indication.• Check the movement of the rack actuator by the active control function. <p>*For details of the method and the procedure of diagnosis, see P.1-193</p>
--	---

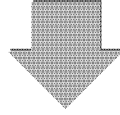

2) Check of connectors/wiring	<ul style="list-style-type: none">• Before beginning your work, be sure to turn off the key switch.• Check that the connector of the rack actuator is correctly inserted.• Check that the wiring of the rack actuator is not disconnected or the insulation of the wiring is not peeled.
-------------------------------	--

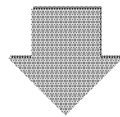

3) Failure Diagnostic Work	<ul style="list-style-type: none">• Check the resistance value of the rack actuator solenoid.• Check the harness for correct continuity. <p>*For details of the method and the procedure of diagnosis, see P.1-193</p>
----------------------------	---

(2) P1212/3: Failure with Rack Actuator (High Current)

DTC	P1213/3	Failure with Rack Actuator (High Current)
-----	---------	---

DTC Detecting Conditions

1 - Precondition; 2 - Detecting condition(s); 3 - Flashing pattern of failure indicator	Check points
1. Key switch ON. 2. Rack actuator current detected equal to or above the upper limit. 3. Eight flashes.	Connector Harness Rack actuator E-ECU

Movement at Error occurrence

Error Mode	[Stop Immediately]: The engine stops running.
Run restricted?	Yes: The rack actuator relay is turned OFF, and the rack position is forcibly set to the engine stop position.
Recovery Conditions	No.
Remarks	

Estimation of Failure cause/Error condition

- The connector may not be properly connected.
 - Wiring defect of the harness
 - The rack actuator wiring may be short-circuited with POWER SUPPLY (*NOTE).
 - The rack actuator may be faulty.
 - Inner wiring of the rack actuator short-circuited with POWER SUPPLY (*NOTE)
- *NOTE) If the rack actuator wiring is short-circuited with POWER SUPPLY, the ECU's power supply line fuse 10A might be blown. With this fuse blown, the E-ECU may fail to detect/indicate the error, and to store the error history.**
- The E-ECU internal circuitry may be faulty.

Diagnosis Description

1) Initial diagnosis with the diagnosis tool	<ul style="list-style-type: none">• Check the fault indication.• Check the movement of the rack actuator by the active control function. <p>*For details of the method and the procedure of diagnosis, see P.1-193</p>
--	---

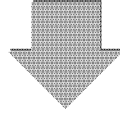

2) Check of connectors/wiring	<ul style="list-style-type: none">• Before beginning your work, be sure to turn off the key switch.• Check that the connector of the rack actuator is correctly inserted.• Check that the wiring of the rack actuator is not disconnected or the insulation of the wiring is not peeled.
-------------------------------	--

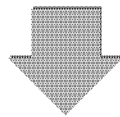

3) Failure Diagnostic Work	<ul style="list-style-type: none">• Check the resistance value of the rack actuator solenoid.• Check the harness for correct continuity. <p>*For details of the method and the procedure of diagnosis, see P.1-193</p>
----------------------------	---

(3) P1211/7: Rack Actuator Mechanical Failure

DTC	P1211/7	Rack Actuator Mechanical Failure
-----	---------	----------------------------------

DTC Detecting Conditions

1 - Precondition; 2 - Detecting condition(s); 3 - Flashing pattern of failure indicator	Check points
1. Key switch ON. 2. Rack operation check at the activation 3. Eight flashes.	Rack

Movement at Error occurrence

Error Mode	[Stop Immediately]: The engine does not start up.
Run restricted?	Yes: The rack actuator relay is turned OFF, and the starter does not rotate.
Recovery Conditions	No.
Remarks	

Estimation of Failure cause/Error condition

- The rack may be stuck.
 - Water entered into the fuel rusts the plunger.

Diagnosis Description

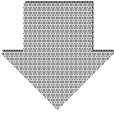
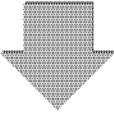
1) Initial diagnosis with the diagnosis tool	<ul style="list-style-type: none">• Check the fault indication.• Check the movement of the rack actuator by the active control function. <p>*For details of the method and the procedure of diagnosis, see P.1-193</p>
	
2) Check of connectors/wiring	<ul style="list-style-type: none">• Before beginning your work, be sure to turn off the key switch.• Check that the connector of the rack actuator is correctly inserted.• Check that the wiring of the rack actuator is not disconnected or the insulation of the wiring is not peeled.
	
3) Failure Diagnostic Work	<ul style="list-style-type: none">• Check the resistance value of the rack actuator solenoid.• Check the harness for correct continuity. <p>*For details of the method and the procedure of diagnosis, see P.1-193</p>

Engine

(1) P1214/2: Engine Trouble

DTC	P1214/2	Engine Trouble
------------	----------------	-----------------------

DTC Detecting Conditions

1 - Precondition; 2 - Detecting condition(s); 3 - Flashing pattern of failure indicator	Check points
1. Key switch ON. 2. (1) Engine stall during a rack position sensor error (2) Unexpected engine speed rise is detected other than acceleration. 3. Eight flashes.	Harness Rack actuator

Movement at Error occurrence

Error Mode	[Stop Immediately]: The engine stops running.
Run restricted?	Yes: The rack actuator relay is turned OFF, and the rack position is forcibly set to the engine stop position.
Recovery Conditions	No.
Remarks	

Estimation of Failure cause/Error condition

- Wiring defect of the harness
 - The rack actuator wiring may be short-circuited with POWER SUPPLY.
 - The rack actuator wiring may be short-circuited with GND.
- Engine over speed loaded by the operating machine's drive
- Control error of the fuel injection pump
 - The rack actuator wiring may be short-circuited with GND.

Diagnosis Description

1) Initial diagnosis
with the diagnosis
tool

- Check the fault indication.

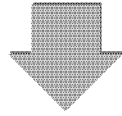

2) Engine Inspection

- Turn the key switch off to stop the engine.
- Inspect the engine and the operating machine.
- After a little, turn the key switch on to check if the DTC is detected.

*For description and procedure of engine inspection, see the Service manual ("Engine").

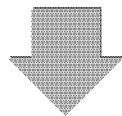

3) Failure Diagnostic
Work

- Check the Rack Actuator.

*For details of the method and the procedure of diagnosis, see P.1-193

E-ECU Internal and Communication Errors

E-ECU Internal Errors

(1) P0601/12, P1610/12, P1611/12, P1612/12: ECU internal errors (1)

DTC	P0601/12	EEPROM error (read/write error)
	P1610/12	Failure A with Sub-CPU
	P1611/12	Failure B with Sub-CPU
	P1612/12	Failure C with Sub-CPU

DTC Detecting Conditions

1 - Precondition; 2 - Detecting condition(s); 3 - Flashing pattern of failure indicator	Check points
1. Key switch ON. 2. E-ECU detects an error of the internal circuit. 3. Four flashes followed by one flash.	E-ECU

Movement at Error occurrence

Error Mode	[Run As Is]: After detecting the error, the system lets the engine continue to run without any restrictions.
Run restricted?	No.
Recovery Conditions	No.
Remarks	

Estimation of Failure cause/Error condition

- The E-ECU internal circuitry may be faulty.

Diagnosis Description

1) Initial diagnosis with the diagnosis tool	<ul style="list-style-type: none"> • Check the fault indication. • Turn the key switch on/off to check the fault indication again. <p>*For details of the method and the procedure of diagnosis, see P.1-197</p>
--	--

(2) P1601/2, P0605/12, P1605/2, P1606/2, P1620/12: ECU internal errors (2)

DTC	P1601/2	EEPROM error (Checksum)
	P0605/12	FlashROM error (Checksum A)
	P1605/2	FlashROM error (Checksum B)
	P1606/2	FlashROM error (Checksum C)
	P1620/12	Map format error

DTC Detecting Conditions

1 - Precondition; 2 - Detecting condition(s); 3 - Flashing pattern of failure indicator	Check points
1. Key switch ON. 2. E-ECU detects an error of the internal circuit. 3. Four flashes followed by one flash.	E-ECU

Movement at Error occurrence

Error Mode	[Stop Immediately]: The engine does not start up.
Run restricted?	Yes: The rack actuator relay is turned OFF, and the rack position is forcibly set to the engine stop position.
Recovery Conditions	No.
Remarks	

Estimation of Failure cause/Error condition

- ROM data error of E-ECU
 - Checksum error of EEPROM initial individual information
 - Checksum error of control application, map data or initial individual information in FlashROM
- * **Checksum A: control application, checksum B: map data, checksum C: initial individual information**
 - Unconformity of the map data format

Diagnosis Description

1) Initial diagnosis with the diagnosis tool	<ul style="list-style-type: none"> • Check the fault indication. • Rewrite the E-ECU software. • Turn the key switch on/off to check the fault indication again. <p>*For details of the method and the procedure of diagnosis, see P.1-197</p>
--	---

(3) P0686/4: Main relay error

DTC	P0686/4	Main relay error
-----	---------	------------------

DTC Detecting Conditions

1 - Precondition; 2 - Detecting condition(s); 3 - Flashing pattern of failure indicator	Check points
1. Key switch OFF. 2. Power supply to ECU fails to turn OFF. 3. One flash followed by six flashes.	Connector Harness Main relay

Movement at Error occurrence

Error Mode	[Run As Is]: After detecting the error, the system lets the engine continue to run without any restrictions.
Run restricted?	No.
Recovery Conditions	No.
Remarks	

Estimation of Failure cause/Error condition

- The connector may not be properly connected.
- Wiring defect of the harness
 - Downstream line of the main relay coil may be short-circuited with GND or POWER SUPPLY (*NOTE).
- The main relay contact may be faulty.
 - The main relay contact may be stuck.
 - Inner wiring of the main relay coil short-circuited with POWER SUPPLY (*NOTE).
- ***NOTE) If the downstream line of the main relay coil is short-circuited with POWER SUPPLY, the E-ECU's power supply line fuse 10A may be blown or the inner circuit of E-ECU may fail. In this case, the E-ECU may fail to detect/indicate the error, and to store the error history.**
- The E-ECU internal circuitry may be faulty.

Diagnosis Description

1) Initial diagnosis with the diagnosis tool	<ul style="list-style-type: none">• Check the fault indication.• Check if a log-in to the diagnosis tool with the key switch OFF is available. <p>*For details of the method and the procedure of diagnosis, see P.1-199</p>
--	---

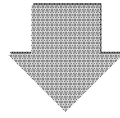

2) Check of connectors/wiring	<ul style="list-style-type: none">• Before beginning your work, be sure to turn off the key switch.• Check that the main relay is inserted to the harness connector correctly.• Check that the wiring of the main relay is not disconnected or the insulation of the wiring is not peeled.
-------------------------------	--

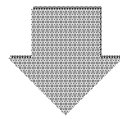

3) Failure Diagnostic Work	<ul style="list-style-type: none">• Check the main relay contact for correct continuity.• Check the resistance value of the main relay.• Check the harness for correct continuity. <p>*For details of the method and the procedure of diagnosis, see P.1-199</p>
----------------------------	--

CAN Communication

(1) U0001/12: CAN Communication Error

DTC	U0001/12	CAN Communication Error
------------	-----------------	--------------------------------

DTC Detecting Conditions

1 - Precondition; 2 - Detecting condition(s); 3 - Flashing pattern of failure indicator	Check points
1. (1) Before and (2) after ECU start-up 2. A necessary CANID cannot be received that should periodically received. 3. One flash followed by two flashes.	Other ECUs Battery Connector Harness E-ECU

Movement at Error occurrence

	Accelerator sensor function	
	CAN communication only	CAN communication plus analog input or pulse accelerator#
Error Mode	[Run Under Restrictions]: The engine runs at a constant rotational speed.	[Run As Is]: The engine continues to run using the analog input or pulse accelerator instead.
Run restricted?	Yes: The target speed is set to the "on-error target speed (standard value: 1500[min^{-1}])" or "pre-error target speed".	No.
Recovery Conditions	Yes: The error is reset when the necessary data is received.	Yes: The error is reset when the necessary data is received.
Remarks		When the error is reset, then the engine switches to CAN communication mode and continues to run.

Estimation of Failure cause/Error condition

- Deactivation of another ECU
- Battery voltage descent
- The connector may not be properly connected.
- Wiring defect of the harness
 - CAN communication line (Hi, Low) may be disconnected, or short-circuited with GND or power supply.
- The E-ECU internal circuitry may be faulty.

Diagnosis Description

1) Initial diagnosis with the diagnosis tool	<ul style="list-style-type: none">• Check the fault indication.• Check the battery voltage. <p>*For details of the method and the procedure of diagnosis, see P.1-203</p>
--	--

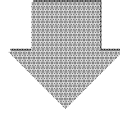

2) Check of connectors/wiring	<ul style="list-style-type: none">• Before beginning your work, be sure to turn off the key switch.• Check that the connector of the CAN communication is correctly inserted.• Check that the wiring of the CAN communication is not disconnected or the insulation of the wiring is not peeled.
-------------------------------	--

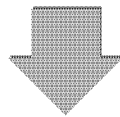

3) Failure Diagnostic Work	<ul style="list-style-type: none">• Check the battery voltage.• Check the harness for correct continuity. <p>*For details of the method and the procedure of diagnosis, see P.1-203</p>
----------------------------	--

Immobilizer

(1) U0167/12: Immobilizer Error (CAN communication)

DTC	U0167/12	Immobilizer Error (CAN communication)
------------	-----------------	--

DTC Detecting Conditions

1 - Precondition; 2 - Detecting condition(s); 3 - Flashing pattern of failure indicator	Check points
1. Key switch ON. 2. If the immobilizer does not respond to a request of authorization start. 3. Four flashes followed by two flashes	Immobilizer Battery Connector Harness E-ECU

Movement at Error occurrence

	Immobilizer pulse communication setting	
	Yes	No
Error Mode	[Run As Is]: Authorization by the emergency pulse communication	[Stop Immediately]: The engine does not start up.
Run restricted?	- (As same as the movement at the immobilizer pulse communication error)	Yes: The rack actuator relay is turned OFF, and the starter does not rotate.
Recovery Conditions	- (As same as the movement at the immobilizer pulse communication error)	No.
Remarks		

Estimation of Failure cause/Error condition

- Battery voltage descent
- The connector may not be properly connected.
- Wiring defect of the harness
 - CAN communication line (Hi, Low) may be disconnected, or short-circuited with GND or power supply.
- The E-ECU internal circuitry may be faulty.

Diagnosis Description

1) Initial diagnosis with the diagnosis tool	<ul style="list-style-type: none">• Check the fault indication.• Check the battery voltage. <p>*For details of the method and the procedure of diagnosis, see P.1-205</p>
--	--

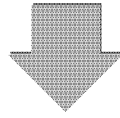

2) Check of connectors/wiring	<ul style="list-style-type: none">• Before beginning your work, be sure to turn off the key switch.• Check that the connector of the CAN communication is correctly inserted.• Check that the wiring of the CAN communication is not disconnected or the insulation of the wiring is not peeled.
-------------------------------	--

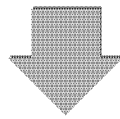

3) Failure Diagnostic Work	<ul style="list-style-type: none">• Check the battery voltage.• Check the harness for correct continuity. <p>*For details of the method and the procedure of diagnosis, see P.1-205</p>
----------------------------	--

(2) U1167/8: Immobilizer Error (pulse communication)

DTC	U1167/8	Immobilizer Error (pulse communication)
------------	----------------	--

DTC Detecting Conditions

1 - Precondition; 2 - Detecting condition(s); 3 - Flashing pattern of failure indicator	Check points
1. Key switch ON. 2. In the case of timeout detection 3. Four flashes followed by two flashes	Immobilizer Connector Harness E-ECU

Movement at Error occurrence

	Immobilizer CAN communication	
	Normal	Error
Error Mode	[Run As Is]: Engine start is authorized.	[Stop Immediately]: The engine does not start up.
Run restricted?	No.	Yes: The rack actuator relay is turned OFF, and the starter does not rotate.
Recovery Conditions	Yes: The error is automatically reset when a normal data is received.	Yes: The error is automatically reset when a normal data is received.
Remarks		

Estimation of Failure cause/Error condition

- The connector may not be properly connected.
- Wiring defect of the harness
 - Pulse communication line may be disconnected, or short-circuited with GND or power supply.
- The E-ECU internal circuitry may be faulty.

Diagnosis Description

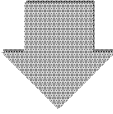
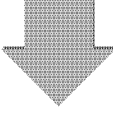
1) Initial diagnosis with the diagnosis tool	<ul style="list-style-type: none">• Check the fault indication. <p>*For details of the method and the procedure of diagnosis, see P.1-205</p>
	
2) Check of connectors/wiring	<ul style="list-style-type: none">• Before beginning your work, be sure to turn off the key switch.• Check that the wiring for the immobilizer pulse communication and E-ECU are correctly connected.• Check that the wiring for the immobilizer pulse communication is not disconnected or the insulation of the wiring is not peeled.
	
3) Failure Diagnostic Work	<ul style="list-style-type: none">• Check the harness for correct continuity. <p>*For details of the method and the procedure of diagnosis, see P.1-205</p>

(3) U0426/2: Immobilizer Error (system)

DTC	U0426/2	Immobilizer Error (system)
-----	---------	----------------------------

DTC Detecting Conditions

1 - Precondition; 2 - Detecting condition(s); 3 - Flashing pattern of failure indicator	Check points
1. Key switch ON. 2. (1) Authorization by CAN communication is NG. (2) Immobilizer CAN communication is faulty, and authorization by immobilizer pulse communication is NG. 3. Four flashes followed by two flashes	Immobilizer authorization key

Movement at Error occurrence

Error Mode	[Stop Immediately]: The engine does not start up.
Run restricted?	Yes: The rack actuator relay is turned OFF, and the starter does not rotate.
Recovery Conditions	No.
Remarks	

Estimation of Failure cause/Error condition

- Unconformity of the immobilizer authorization key

Diagnosis Description

1) Initial diagnosis with the diagnosis tool	• Check that the immobilizer authorization key is correct.
--	--

METHOD AND PROCEDURE OF FAILURE DIAGNOSIS

Description Items

Related DTC

Related DTC(s) is listed.

DTC	Code Number	Error Name
-----	-------------	------------

Work flow

Work flow for the failure diagnosis is listed,

Wiring Diagram

Shows a wiring diagram that encompasses the components/parts associated with the failure.

Work Description

Describes how to diagnose and correct the failure.

E-ECU Pin Layout Diagram

Harness side coupler (coupling face)

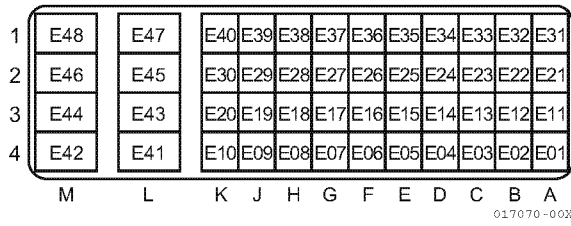

ECU side coupler (coupling face)

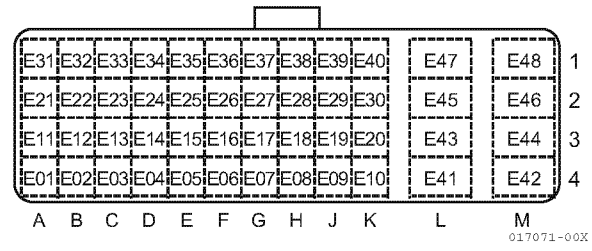

No.	Pin function name	Code
E01	4-A STEP MOTOR D-PHASE	STPM-D
E02	4-B APPLICATION OPEN OUTPUT 2	APP-OP2
E03	4-C RxD1	RxD
E04	4-D TxD1	TxD
E05	4-E APPLICATION OPEN INPUT 5	APP-IP5
E06	4-F APPLICATION OPEN INPUT 6	APP-IP6
E07	4-G Key switch	IGNSW
E08	4-H ENGINE START RECOGNITION	STARTSW
E09	4-J APPLICATION OPEN INPUT 3	APP-IP3
E10	4-K Spare speed sensor	REN RPM
E11	3-A STEP MOTOR C-PHASE	STPM-C
E12	3-B FAILURE INDICATOR LAMP	FAIL-LMP
E13	3-C APPLICATION OPEN INPUT 7	APP-IP7
E14	3-D APPLICATION OPEN INPUT 2	APP-IP2
E15	3-E EMERGENCY ENGINE STOP	SHUDNSW
E16	3-F COOLING WATER TEMPERATURE (HIGH ACCURACY)	RET
E17	3-G APPLICATION OPEN INPUT 4	APP-IP4
E18	3-H SPEED INPUT (-)	NRPM-GND
E19	3-J SPEED INPUT (+)	NRPM
E20	3-K APPLICATION OPEN OUTPUT 1	APP-OP1
E21	2-A STEP MOTOR B-PHASE	STPM-B
E22	2-B SPEED MONITOR	NRPM-M
E23	2-C PREHEAT LAMP	PREHT-LMP
E24	2-D APPLICATION OPEN INPUT 1	APP-IP1

No.	Pin function name	Code
E25	2-E COOLING WATER TEMPERATURE (CONVENTIONAL)	TW
E26	2-F INTAKE TEMPERATURE	TAIR
E27	2-G EGR TEMPERATURE	TEGR
E28	2-H SENSOR GND	GND-A
E29	2-J BOOT MODE	BOOTSW
E30	2-K CAN TERMINAL RESISTANCE SWITCH-OVER	RECAN
E31	1-A STEP MOTOR A-PHASE	STPM-A
E32	1-B LOAD FACTOR MONITOR 1	LOAD-M
E33	1-C RACK ACTUATOR RELAY	RACK-RLY
E34	1-D Main relay	MAIN-RLY
E35	1-E ACCELERATOR POSITION SENSOR	APS
E36	1-F Rack position sensor	RPS
E37	1-G RESERVED ANALOG	REAN
E38	1-H SENSOR 5V	AVCC
E39	1-J CANL	CANL
E40	1-K CANH	CANH
E41	4-L CSD Solenoid Valve Coil	CSD-CL
E42	4-M Rack actuator	RACKSOL
E43	3-L SENSOR 12V	AVB
E44	3-M START ASSIST RELAY	AIRHT-RLY
E45	2-L POWER SUPPLY GND	GND
E46	2-M (FLY-BACK)	(FB)
E47	1-L POWER GND	GND-P
E48	1-M POWER SUPPLY 12V	VB

How to use the 2G eco-checker harness

Failure diagnosis for area listed in the following correspondence list includes the work measuring voltage with the 2G eco-checker harness. Therefore before the failure diagnosis, remove the E-ECU and machine's harness, and connect the 2G eco-checker harness between the E-ECU and machine's harness.

- * For details of the failure diagnosis for each area, see the followings.
- * Measure the voltage using a circuit tester referring the following list.

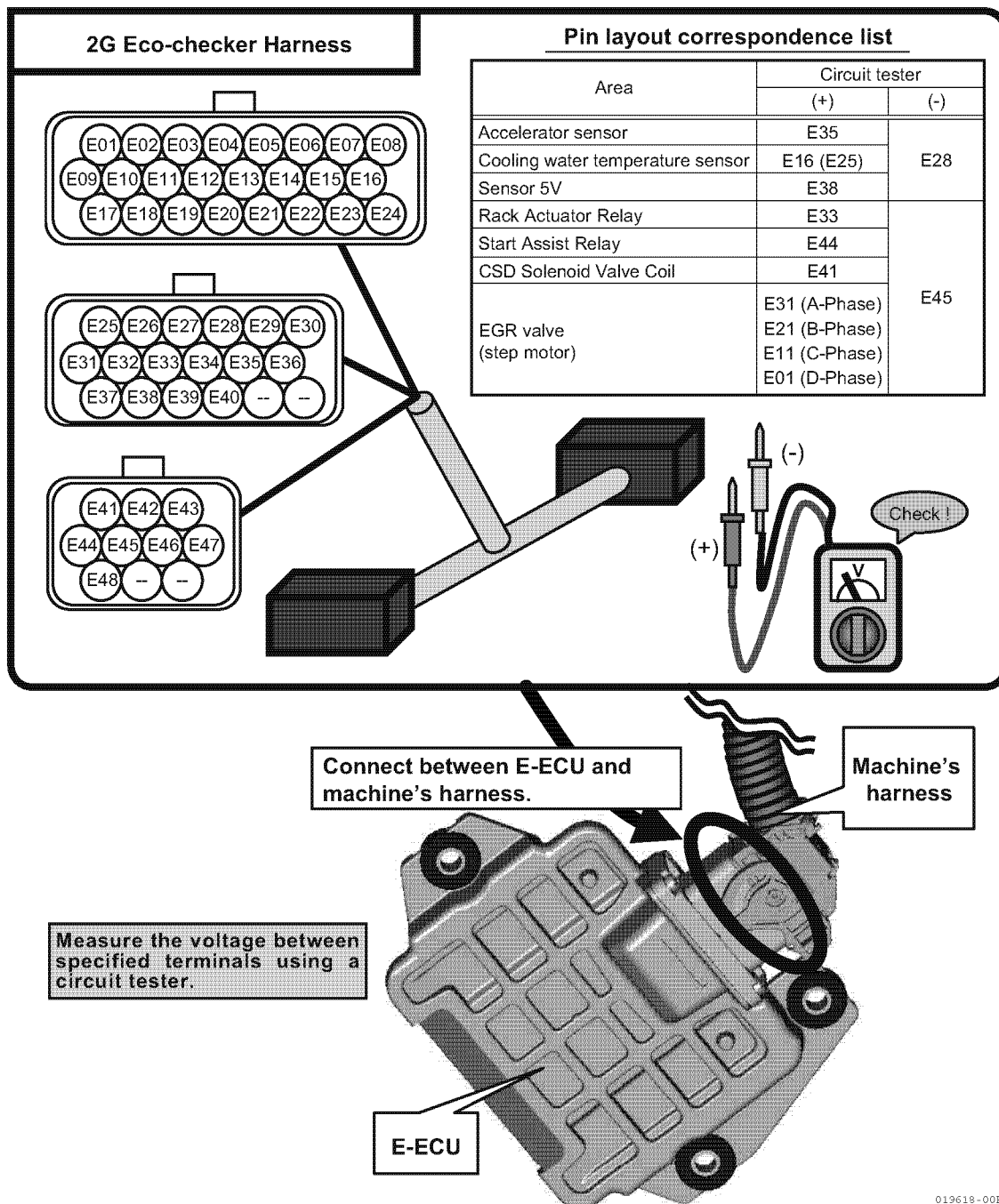

Connect between E-ECU and machine's harness.

Measure the voltage between specified terminals using a circuit tester.

E-ECU

Machine's harness

019618-00E

Analog Input Related Failures

Rack position sensor

Related DTC

DTC	P1202/4	Rack Position Sensor Error (Low Voltage)
	P1203/3	Rack Position Sensor Error (High Voltage)

Work flow

*For details of the work, see after-mentioned "<Diagnosis Description>." For the operation of the diagnosis tool, see "Diagnosis tool Operation Manual" separately.

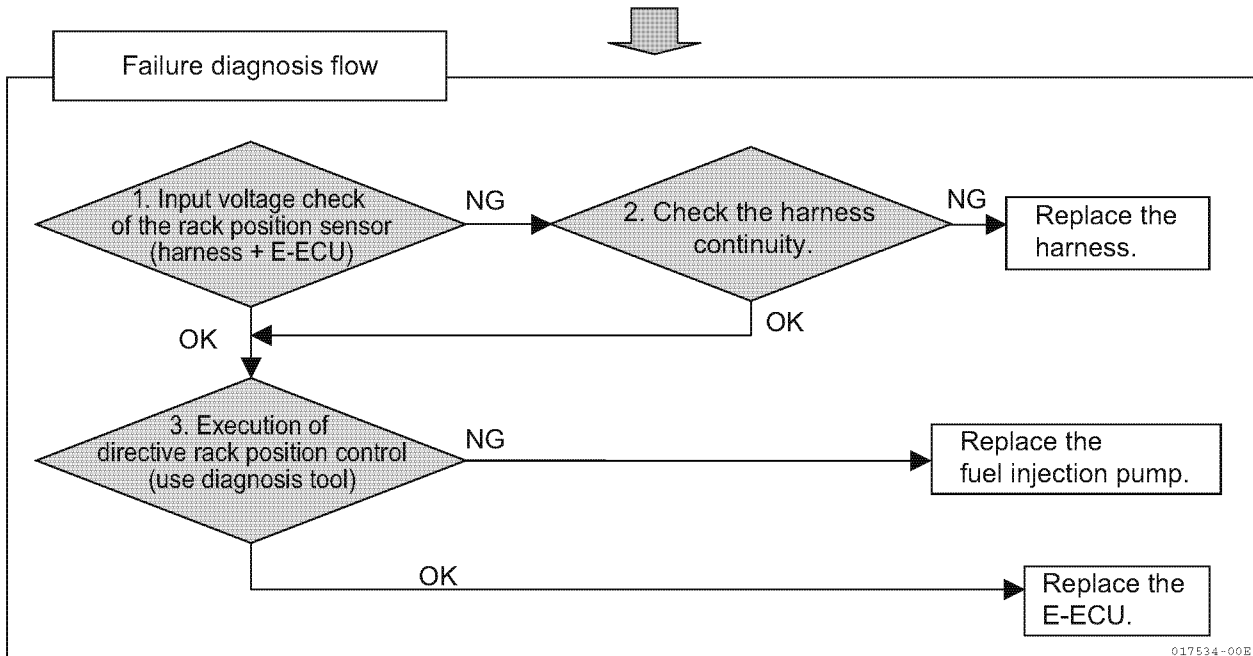
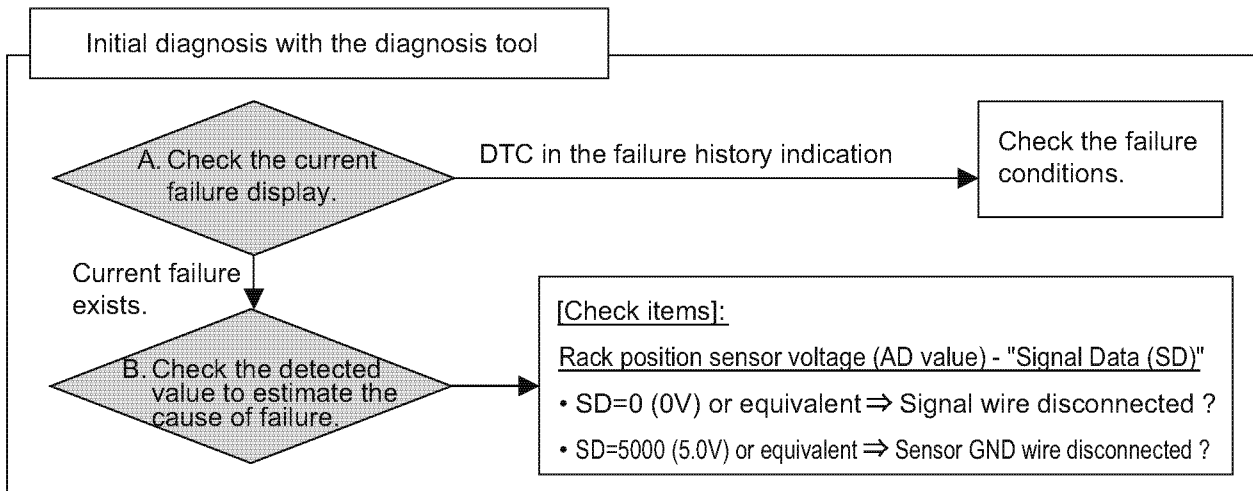

017534-00E

Wiring Diagram

 : Check points

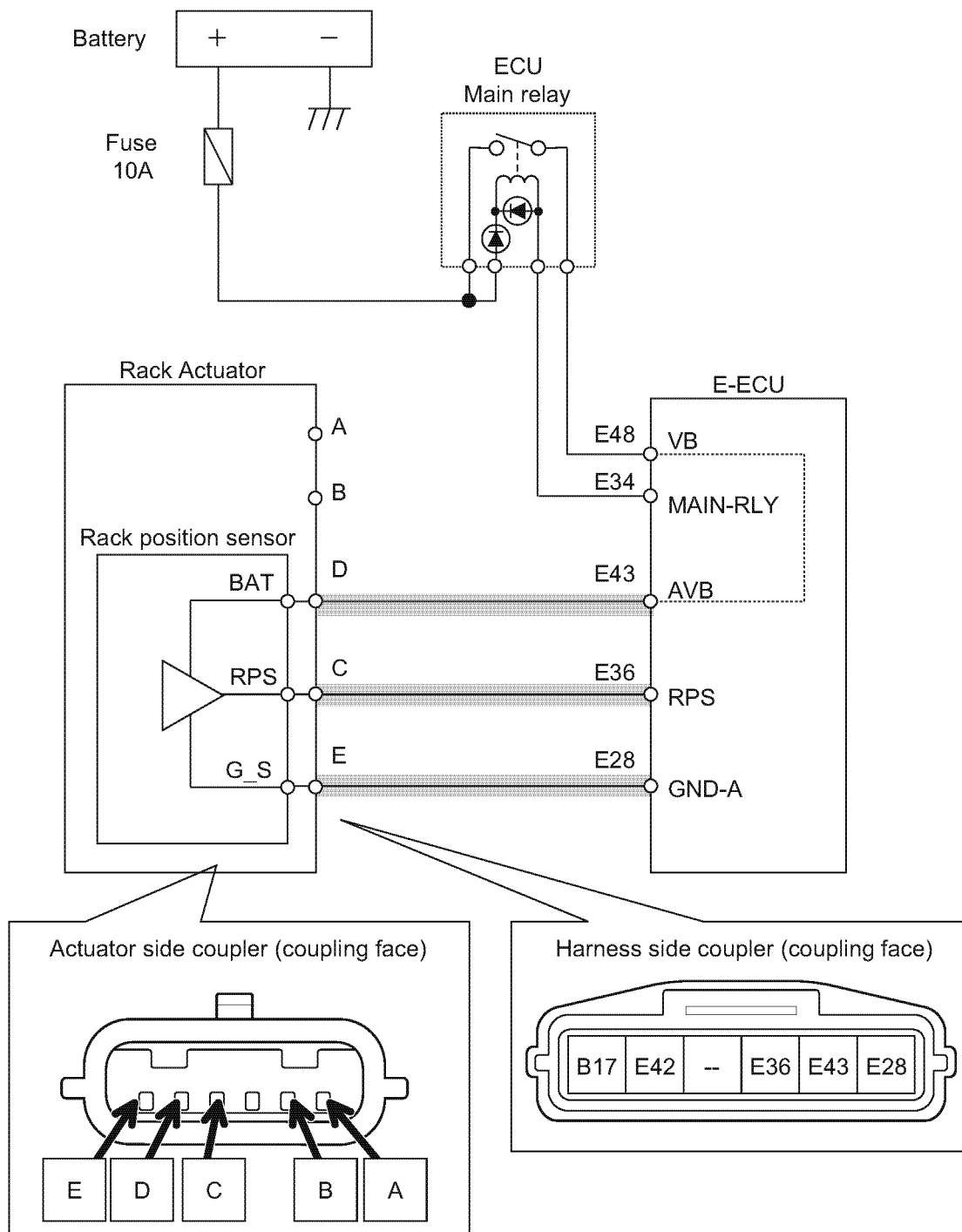

017535-00E

*For the E-ECU Pin Layout, see [E-ECU Pin Layout Diagram] (P.1-134).

Diagnosis Description

1. Check of the input voltage of the rack position sensor (harness + E-ECU)

- Turn the key switch off, and remove the rack actuator connector from the fuel injection pump. At this time, keep the E-ECU connector being connected to E-ECU.
- Turn the key switch on to turn on the E-ECU power.
- Measure the voltage between sensor terminal E43 and E28 using a circuit tester.

Terminal	Normal value
Sensor connector E43 - E28	Equivalent to the battery voltage

NG	Check the harness for correct continuity. → Go to [2. Check of harness continuity:]
OK	Check if the “Directive rack position control” is executable using the diagnosis tool “Diagnosis Test: Active control”. → Go to [3. Execution check of the directive rack position control:]

2. Check of harness continuity:

- Remove the rack actuator connector and E-ECU from the harness.
- Check the harness continuity using a circuit tester.

Terminal	Continuity	Status
Sensor signal wire E36 [Between E-ECU and sensor connector]	Available	OK: normal
	Unavailable	NG: harness disconnection
Sensor GND wire E28 [Between E-ECU and sensor connector]	Available	OK: normal
	Unavailable	NG: harness disconnection
Sensor 12V wire E43 [Between E-ECU and sensor connector]	Available	OK: normal
	Unavailable	NG: harness disconnection
Between E36 and other terminal/GND and between E43 and other terminal/GND	Unavailable	OK: normal
	Available	NG: harness short-circuited with GND
Between E28 and GND/E45/E47	Available	OK: normal
	Unavailable	NG: harness disconnection
Between E28 and other terminals	Unavailable	OK: normal
	Available	NG: harness short-circuited with another wiring

NG	<ul style="list-style-type: none"> • Check if the harness is damaged, or if the wiring is correct. • Replace the harness.
OK	Check if the “Directive rack position control” is executable using the diagnosis tool “Diagnosis Test: Active control”. → Go to [3. Execution check of the directive rack position control:]

3. Execution check of the directive rack position control:
- Connect the all connectors (sensors, E-ECU).
 - Connect the diagnosis tool, and log in to the diagnosis tool after key switch turning-on.
 - Execute the directive rack position control with the diagnosis tool "Diagnosis Test: Active control". At this time, set the rack position arbitrarily within an allowable setting range.
 - After the execution, check if the rack actuator moved to the set rack position.

NG	Replace the fuel injection pump.
OK	Replace the E-ECU.

Accelerator sensor

Related DTC

DTC	P0122/4	Accelerator Sensor Error (Low Voltage)
	P0123/3	Accelerator Sensor Error (High Voltage)
	P0124/2	Intermittent Failure with Accelerator Sensor

Work flow

*For details of the work, see after-mentioned "<Work Description>."For the operation of the diagnosis tool, see "Diagnosis tool Operation Manual" separately.

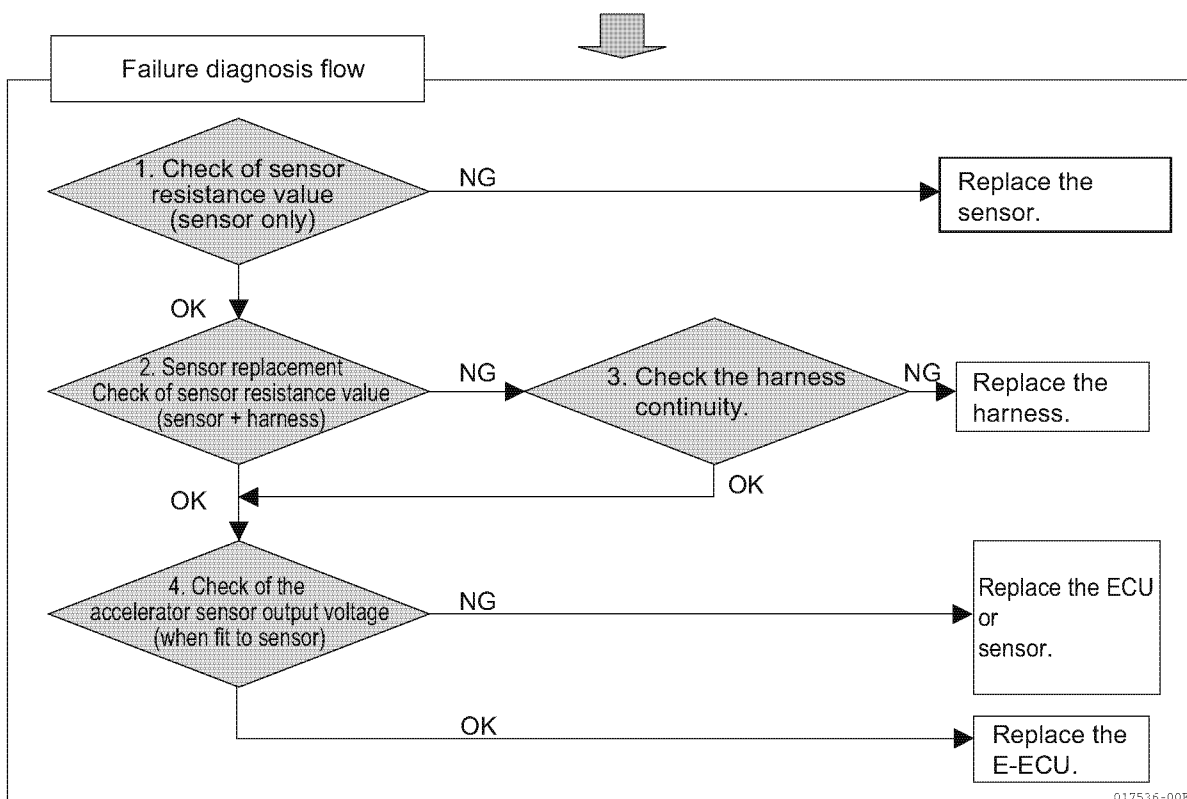
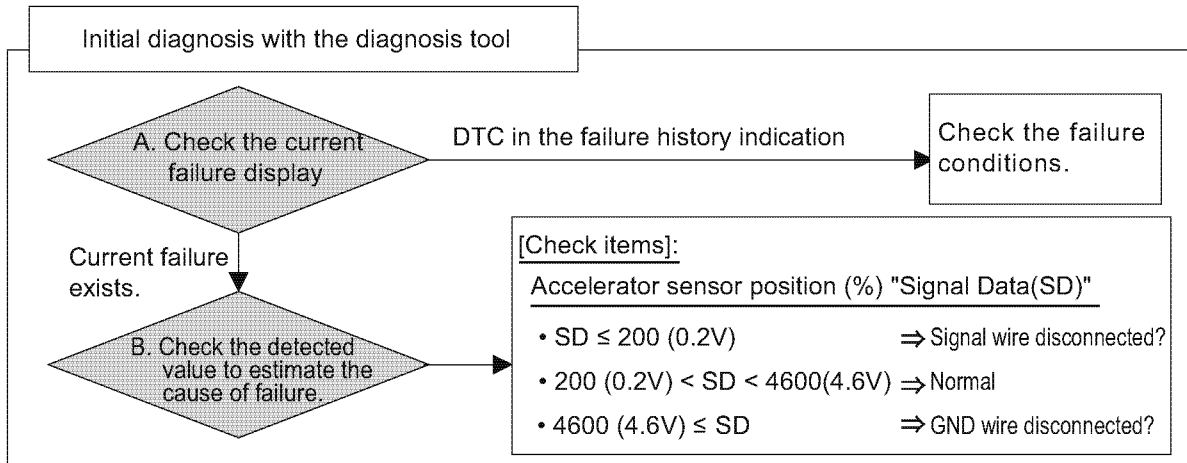

017536-00E

Wiring Diagram

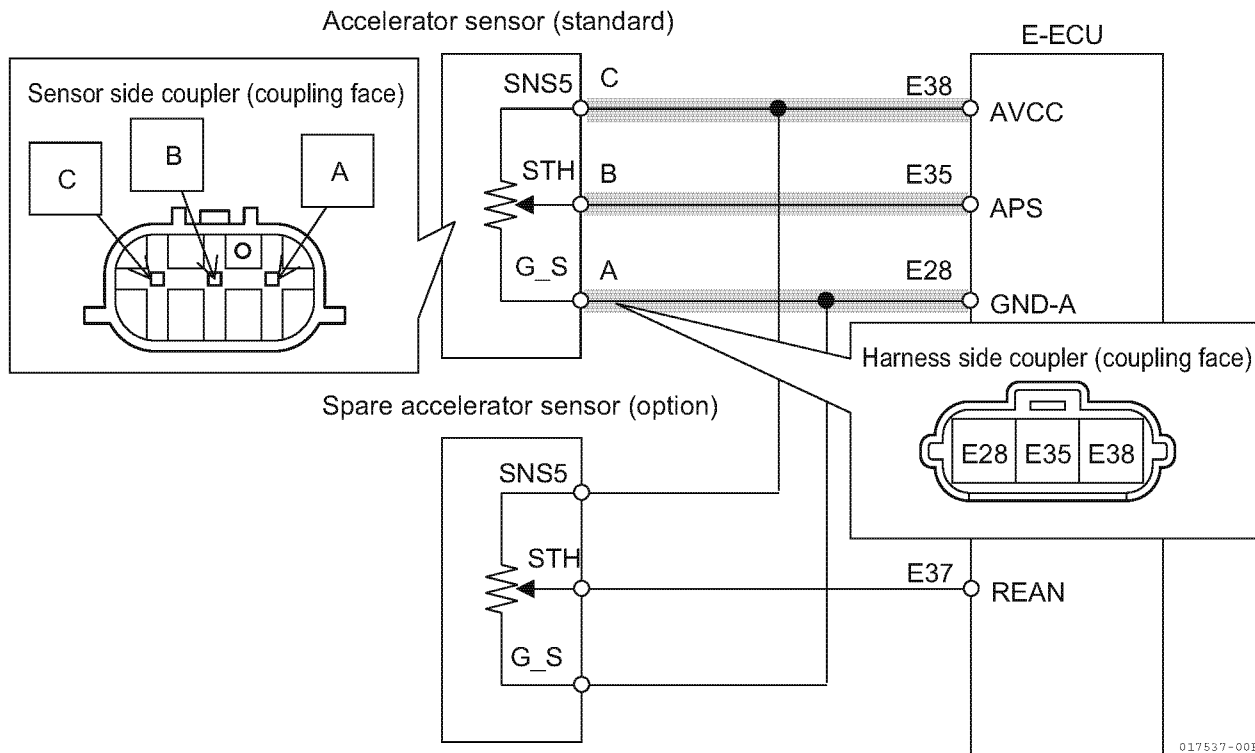
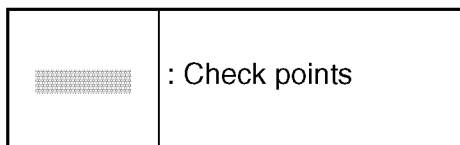

017537-00E

*For the E-ECU Pin Layout, see [E-ECU Pin Layout Diagram] (P.1-134) .

Work Description

1. Check of the sensor resistance value (sensor only):

- Between accelerator sensor terminals A and C (all the resistance value)
- Remove the accelerator sensor from the harness.
- Measure the resistance between sensor terminals A and C (all the resistance value) using a circuit tester.

(REF) Total resistance value of Yanmar standard accelerator sensors

Terminal	Specification
Sensor A - C	$5 \pm 1.5k\Omega$

NG	Replace the accelerator sensor.
OK	Check the resistance value between accelerator sensor terminal A and B. → Go to [• Between accelerator sensor terminals A and B]

- Between accelerator sensor terminals A and B
- Measure the resistance between accelerator sensor terminals A and B using a circuit tester.
- Check if the resistance value between accelerator sensor terminal A and B fluctuates when the accelerator throttle is moved.

NG	Replace the accelerator sensor.
OK	Check the sensor resistance with the sensor and the harness being connected. → Go to [2. Check of the sensor resistance value (sensor + harness):]

2. Check of the sensor resistance value (sensor + harness):

- Between harness E38 and E28 (total resistance value)
- Connect accelerator sensor and harness, and remove E-ECU from the harness.
- Measure the resistance between harness side E-ECU connectors E38 and E28 (total resistance value) using a circuit tester.

*See above-mentioned “(REF) Total resistance value of Yanmar standard accelerator sensors”.

NG	Check the harness for correct continuity. → [3. Check of harness continuity:]
OK	Check the resistance value between the harness E35 and E28. → Go to [• Between harness E38 and E28]

- Between harness E38 and E28
- Measure the resistance between E-ECU connectors E35 and E28 using a circuit tester.
- Check if the resistance value between E-ECU connectors E35 and E28 fluctuates when the accelerator throttle is moved.

NG	Check the harness for correct continuity. → [3. Check of harness continuity:]
OK	Check the sensor resistance with the sensor and the harness being connected. → [2. Check of the sensor resistance value (sensor + harness):]

3. Check of harness continuity:

- Remove the accelerator sensor and E-ECU from the harness.
- Check the harness continuity using a circuit tester.

Terminal	Continuity	Status
Sensor signal wire E35 [Between E-ECU and sensor connector]	Available	OK: normal
	Unavailable	NG: harness disconnection
Sensor GND wire E28 [Between E-ECU and sensor connector]	Available	OK: normal
	Unavailable	NG: harness disconnection
Sensor 5V wire E38 [Between E-ECU and sensor connector]	Available	OK: normal
	Unavailable	NG: harness disconnection
Between E35 and other terminal/GND and between E38 and other terminal/GND	Unavailable	OK: normal
	Available	NG: harness short-circuited with GND
Between E28 and GND/E45/E47	Available	OK: normal
	Unavailable	NG: harness disconnection
Between E28 and other terminals	Unavailable	OK: normal
	Available	NG: harness short-circuited with another wiring

NG	<ul style="list-style-type: none"> • Check if the harness is damaged, or if the wiring is correct. • Replace the harness.
OK	Check the output voltage of the accelerator sensor. → Go to [4. Check of the accelerator sensor output voltage:]

4. Check of the accelerator sensor output voltage:

- Connect the 2G eco-checker harness between E-ECU and machine's harness (for details, see [How to use the 2G eco-checker harness] (P.1-135) And connect the all connectors (sensors, E-ECU).
- Measure the voltage between sensor signal E35 and E28 using a circuit tester.

Voltage	Status	Action
$E35 \leq 0.2[V]$	NG	<ul style="list-style-type: none"> • Replace the harness. • Replace the accelerator sensor.
$0.2[V] < E35 < 4.6[V]$	OK (Normal range)	Replace E-ECU.
$4.6V \leq E35$	NG	<ul style="list-style-type: none"> • Replace the harness. • Replace the accelerator sensor.

NG	<ul style="list-style-type: none"> • Check if the harness is damaged, or if the wiring is correct. • Replace the harness.
OK	Replace E-ECU.

Foot pedal

Related DTC

DTC	P1125/1	Accelerator Sensor Error (foot pedal-close position)
	P1126/0	Accelerator Sensor Error (foot pedal-open position)
	P1225/1	Spare Accelerator Sensor Error (foot pedal-close position)
	P1226/0	Spare Accelerator Sensor Error (foot pedal-open position)

Work flow

*For details of the work, see after-mentioned "<Work Description>." For the operation of the diagnosis tool, see "Diagnosis tool Operation Manual" separately.

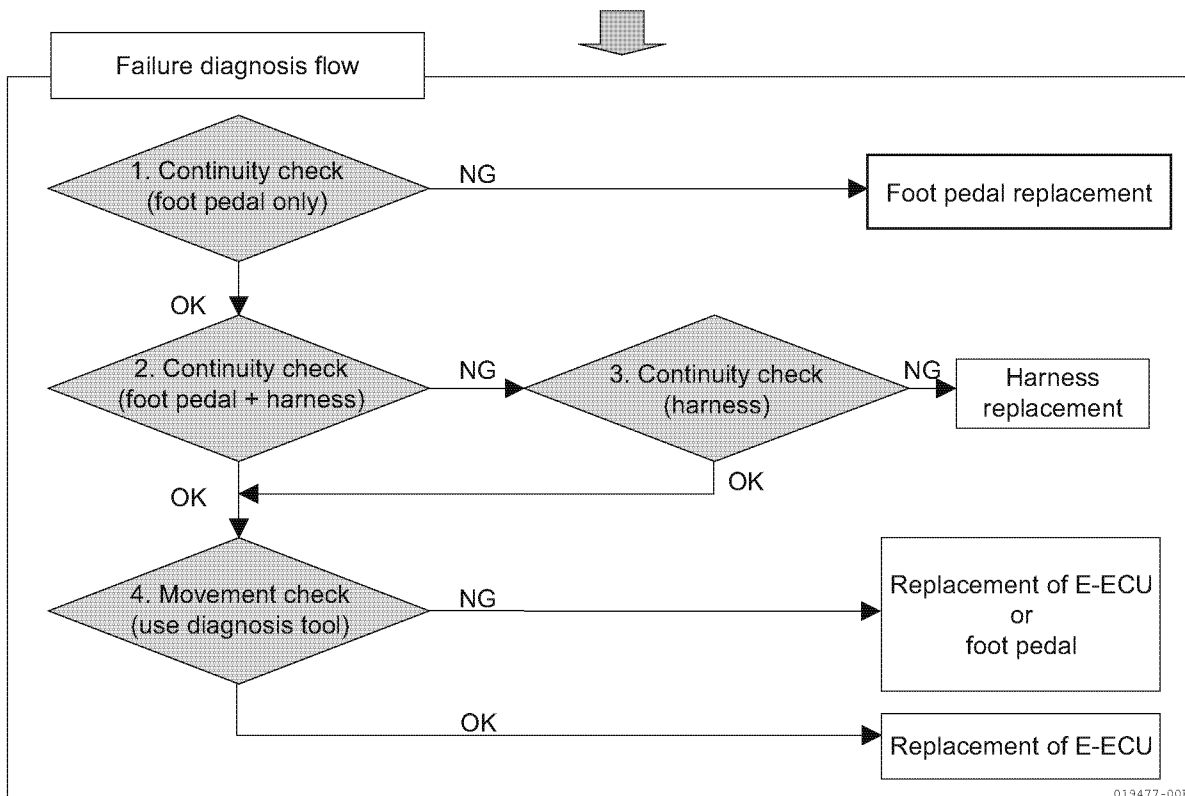
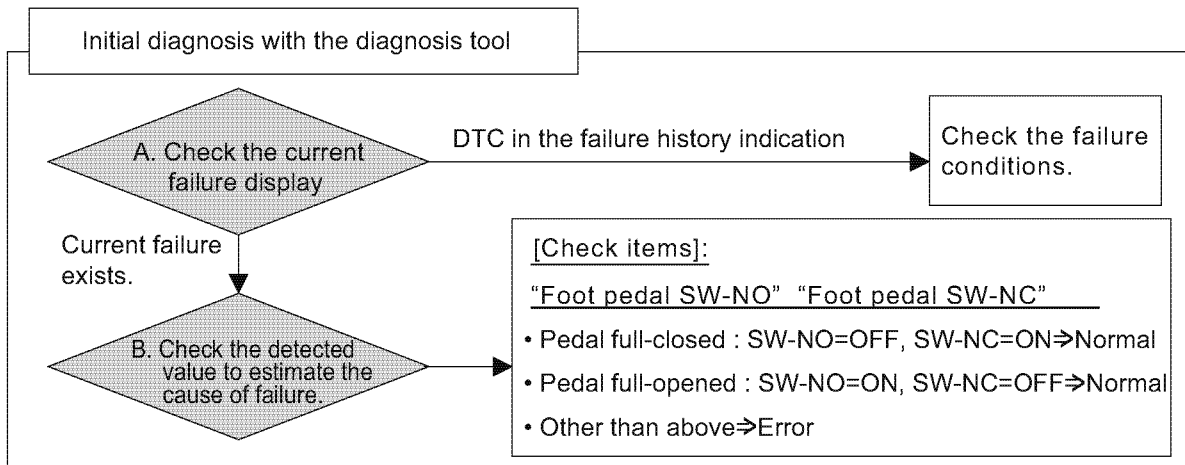

019477-00B

Wiring Diagram

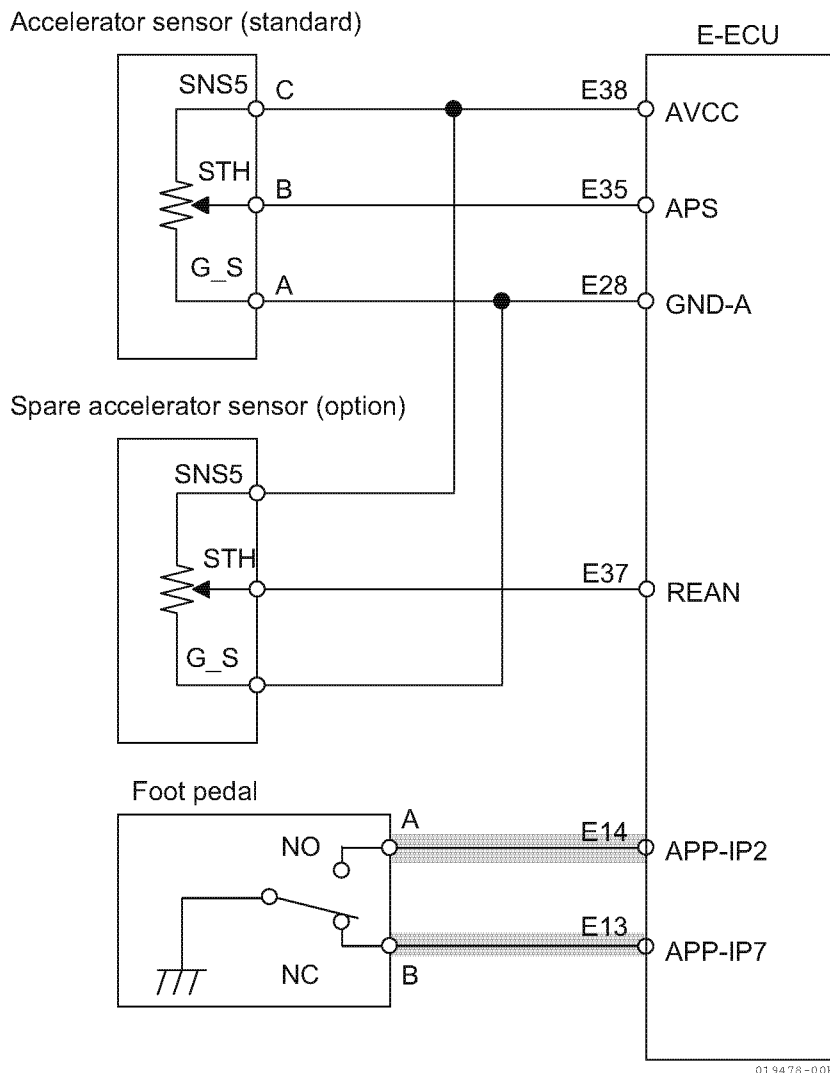
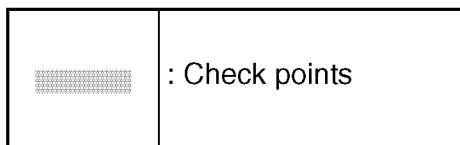

019476-00B

*For the E-ECU Pin Layout, see [E-ECU Pin Layout Diagram] (P.1-134).

Work Description

1. Continuity check (foot pedal only):

- Remove the foot pedal from the harness.
- Check the foot pedal continuity with a specified pedal opening using a circuit tester.

Pedal opening	Continuity		Status
	Between A and GND	Between B and GND	
Full close position	Unavailable	Available	OK: normal
	Unavailable	Unavailable	NG: Internal circuitry fault
	Available	Unavailable	NG: Internal circuitry fault
	Available	Available	NG: Internal circuitry fault
Full open position	Available	Unavailable	OK: normal
	Unavailable	Unavailable	NG: Internal circuitry fault
	Unavailable	Available	NG: Internal circuitry fault
	Available	Available	NG: Internal circuitry fault

NG	Replace the foot pedal.
OK	Check the continuity with the foot pedal and the harness being connected. → Go to [2. Continuity check (foot pedal + harness):]

2. Continuity check (foot pedal + harness):

- Connect foot pedal and harness, and remove E-ECU from the harness.
- Check the foot pedal continuity with a specified pedal opening using a circuit tester.

Pedal opening	Continuity		Status
	Between E-14 and GND	Between E-13 and GND	
Full close position	Unavailable	Available	OK: normal
	Unavailable	Unavailable	NG: Internal circuitry fault
	Available	Unavailable	NG: Internal circuitry fault
	Available	Available	NG: Internal circuitry fault
Full open position	Available	Unavailable	OK: normal
	Unavailable	Unavailable	NG: Internal circuitry fault
	Unavailable	Available	NG: Internal circuitry fault
	Available	Available	NG: Internal circuitry fault

NG	Check the harness for correct continuity. → Go to [3. Check of harness continuity:]
OK	Check if the foot pedal movement is correctly recognized with the diagnosis tool "Diagnosis Test". → Go to [4. Foot pedal movement check:]

3. Check of harness continuity:

- Remove the foot pedal and E-ECU from the harness.
- Check the harness continuity using a circuit tester.

Terminal	Continuity	Status
Pedal signal wire (A) E14 [Between E-ECU and pedal connector]	Available	OK: normal
	Unavailable	NG: harness disconnection
Pedal signal wire (B) E13 [Between E-ECU and pedal connector]	Available	OK: normal
	Unavailable	NG: harness disconnection
Between E14 and other terminal/GND and between E13 and other terminal/GND	Unavailable	OK: normal
	Available	NG: harness short-circuited with GND

NG	<ul style="list-style-type: none"> • Check if the harness is damaged, or if the wiring is correct. • Replace the harness.
OK	Check if the foot pedal movement is correctly recognized with the diagnosis tool "Diagnosis Test". → Go to [4. Foot pedal movement check:]

4. Foot pedal movement check:

- Connect the all connectors (foot pedal, E-ECU).
- Connect the diagnosis tool, and log in to the diagnosis tool after key switch turning-on.
- With the diagnosis tool "Diagnosis Test: Pulse/Analog etc.", operate the pedal to obtain the specified sensor voltage watching "accelerator sensor position", and fix it at that opening.
- With the diagnosis tool "Diagnosis Test: Digital Input etc.", make "Foot pedal SW-NO" and "Foot pedal SW-NC" be displayed, and check the status of ON/OFF.

Sensor voltage	Foot pedal		Action
	SW-NO	SW-NC	
0.65[V] and below	OFF	ON	Replace the E-ECU.
	Other than above		<ul style="list-style-type: none"> • Replace the harness. • Replace the accelerator sensor.
1.1[V] and above	ON	OFF	Replace the E-ECU.
	Other than above		<ul style="list-style-type: none"> • Replace the harness. • Replace the accelerator sensor.

Spare Analog (Spare accelerator sensor, Atmospheric pressure sensor)

Related DTC

DTC	P0222/4	Failure with Spare Accelerator Sensor (Low Voltage)
	P0223/3	Spare Accelerator Sensor Error (High Voltage)
	P0224/2	Intermittent Failure with Spare Accelerator Sensor
	P2228/4	Failure with Atmospheric Pressure Sensor (Low Voltage)
	P2229/3	Failure with Atmospheric Pressure Sensor (High Voltage)
	P2230/2	Intermittent Failure with Atmospheric Pressure Sensor

Work flow

*For details of the work, see after-mentioned "<Diagnosis Method, Procedure>." For the operation of the diagnosis tool, see "Diagnosis tool Operation Manual" separately.

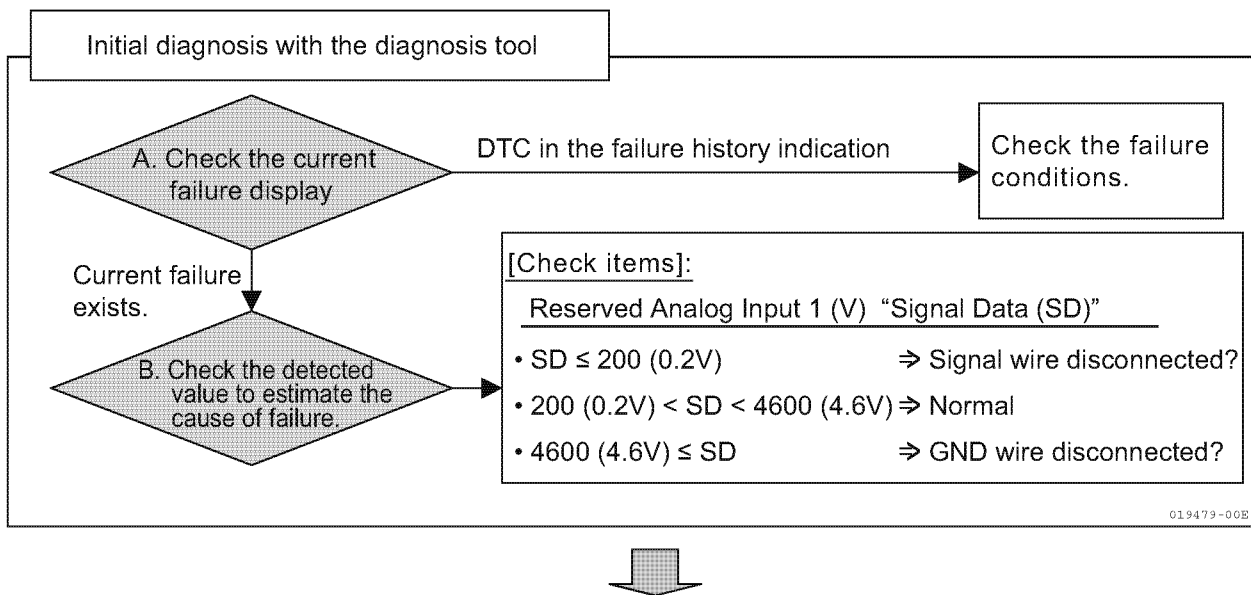

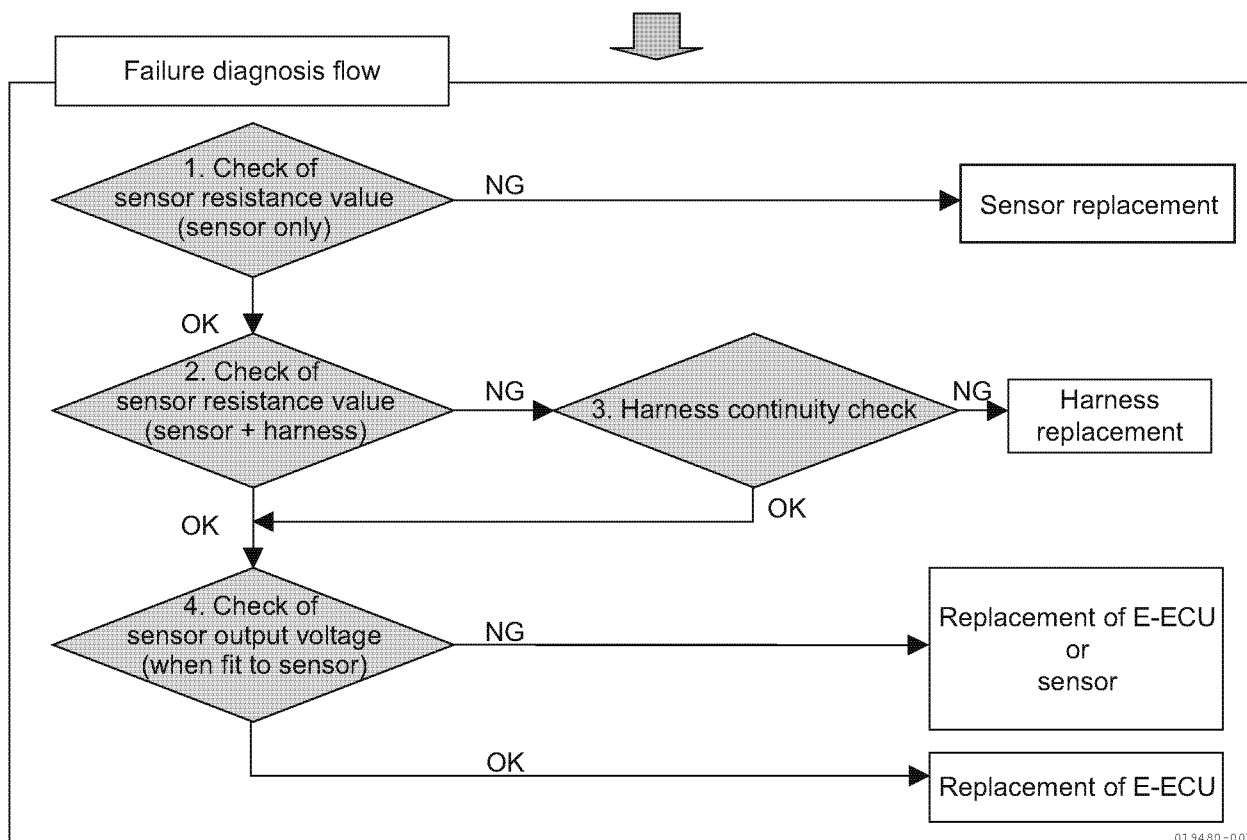

Wiring Diagram

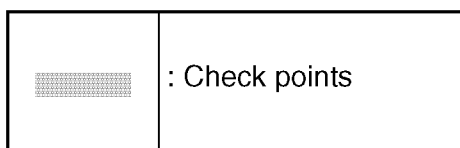

Spare accelerator sensor
or
Atmospheric pressure sensor

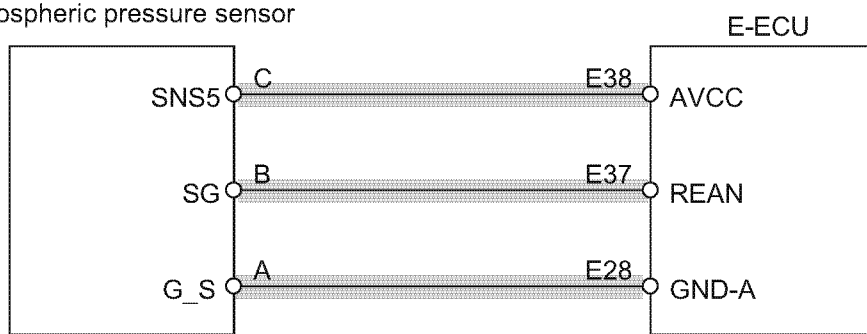

*For the E-ECU Pin Layout, see [E-ECU Pin Layout Diagram] (P.1-134).

Work Description

1. Check of the sensor resistance value (sensor only):

- Between sensor terminal A and C of the spare accelerator sensor or the atmospheric pressure sensor (total resistance value)
 - Remove the harness from the spare accelerator sensor or the atmospheric pressure sensor.
 - Measure the resistance between sensor terminals A and C (total resistance value) using a circuit tester.
- (REF) Total resistance value of Yanmar standard spare accelerator sensor or atmospheric pressure sensor

Terminal	Specification
Sensors A - C	$5 \pm 1.5k\Omega$

NG	Replace the spare accelerator sensor or the atmospheric pressure sensor.
OK	Check the resistance value between terminal A and B of the spare accelerator sensor or the atmospheric pressure sensor. → Go to [• Between sensor terminal A and B of the spare accelerator sensor or the atmospheric pressure sensor]

- Between sensor terminal A and B of the spare accelerator sensor or the atmospheric pressure sensor
- Measure the resistance between sensor terminals A and B using a circuit tester.
- Check if the resistance value between sensor terminal A and B fluctuates when the sensor opening is changed.

NG	Replace the spare accelerator sensor or the atmospheric pressure sensor.
OK	Check the sensor resistance with the sensor and the harness being connected. → Go to [2. Check of the sensor resistance value (sensor + harness):]

2. Check of the sensor resistance value (sensor + harness):

- Between harness E38 and E28 (all the resistance value)
- Connect sensor and harness, and remove E-ECU from the harness.
- Measure the resistance between harness side E-ECU connectors E38 and E28 (all the resistance value) using a circuit tester. *Refer to above-mentioned sensor resistance values.

NG	Check the harness for correct continuity. → Go to [3. Check of harness continuity:]
OK	Check the resistance value between the harness E37 and E28. → Go to [• Between harness E37 and E28]

- Between harness E37 and E28
- Measure the resistance between E-ECU connectors E37 and E28 using a circuit tester.
- Check if the resistance value between E-ECU connector E37 and E28 fluctuates when the sensor opening is changed.

NG	Check the harness for correct continuity. → Go to [3. Check of harness continuity:]
OK	Check the sensor resistance with the sensor and the harness being connected. → Go to [2. Check of the sensor resistance value (sensor + harness):]

3. Check of harness continuity:

- Remove the accelerator sensor and E-ECU from the harness.
- Check the harness continuity using a circuit tester.

Terminal	Continuity	Status
Sensor signal wire E37 [Between E-ECU and sensor connector]	Available	OK: normal
	Unavailable	NG: harness disconnection
Sensor GND wire E28 [Between E-ECU and sensor connector]	Available	OK: normal
	Unavailable	NG: harness disconnection
Sensor 5V wire E38 [Between E-ECU and sensor connector]	Available	OK: normal
	Unavailable	NG: harness disconnection
Between E37 and other terminal/GND, and between E38 and other terminal/GND	Unavailable	OK: normal
	Available	NG: harness short-circuited with GND
Between E28 and GND/E45/E47	Available	OK: normal
	Unavailable	NG: harness disconnection
Between E28 and other terminals	Unavailable	OK: normal
	Available	NG: harness short-circuited with another wiring

NG	<ul style="list-style-type: none"> • Check if the harness is damaged, or if the wiring is correct. • Replace the harness.
OK	Check the output voltage of the spare accelerator sensor or the atmospheric pressure sensor. → Go to [4. Check of the sensor output voltage:]

4. Check of the sensor output voltage:

- Connect the 2G eco-checker harness between E-ECU and machine's harness (for details, see [How to use the 2G eco-checker harness] (P.1-135). And connect the all connectors (sensors, E-ECU).
- Measure the voltage between sensor signal E37 and E28 using a circuit tester.

Voltage	Status	Action
$E37 \leq 0.2[V]$	NG	<ul style="list-style-type: none"> • Replace the harness. • Replace the sensor.
$0.2[V] < E37 < 4.6[V]$	OK (normal range)	Replace the E-ECU.
$4.6V \leq E37$	NG	<ul style="list-style-type: none"> • Replace the harness. • Replace the sensor.

NG	<ul style="list-style-type: none"> • Check if the harness is damaged, or if the wiring is correct. • Replace the harness.
OK	Replace the E-ECU.

Pulse accelerator

Related DTC

DTC	P1127/8	Failure with Spare Accelerator Sensor (Pulse Communication)
-----	---------	---

Work flow

*For details of the work, see after-mentioned "<Work Description>." For the operation of the diagnosis tool, see "Diagnosis tool Operation Manual" separately.

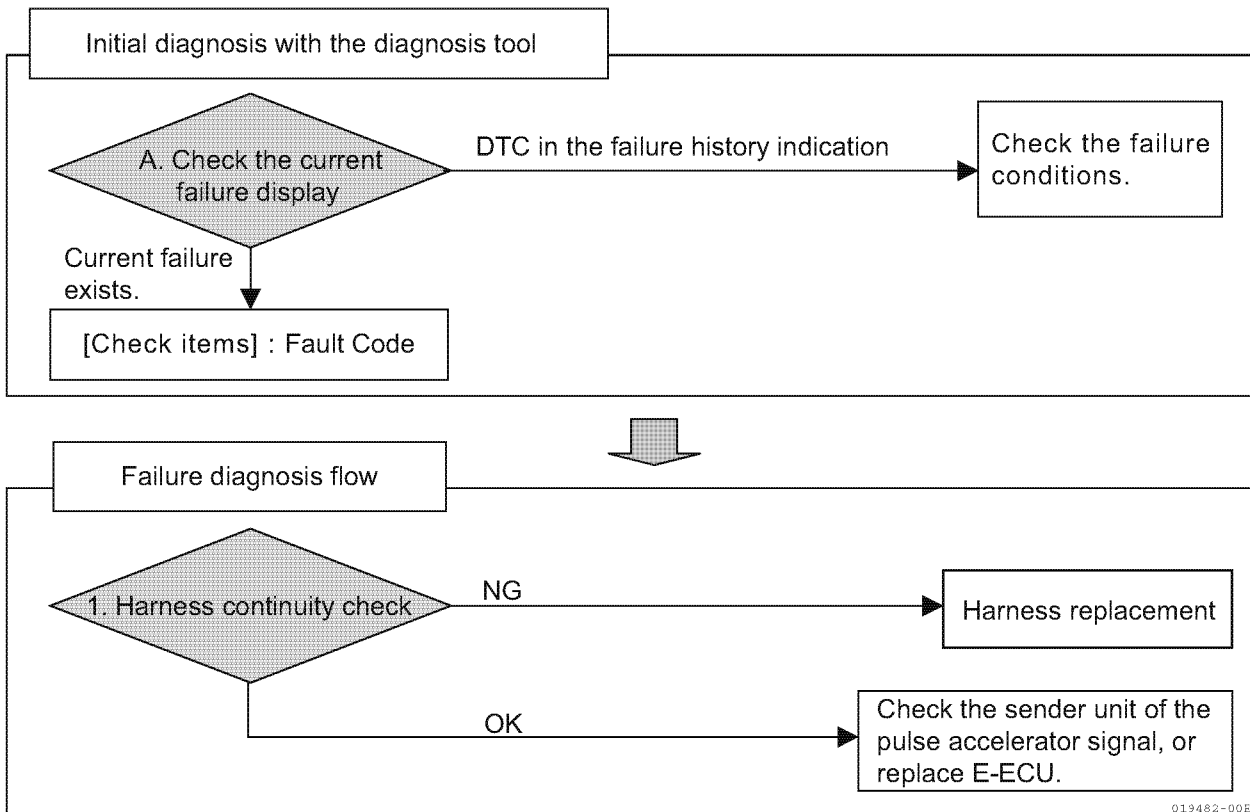

013482-00B

Wiring Diagram

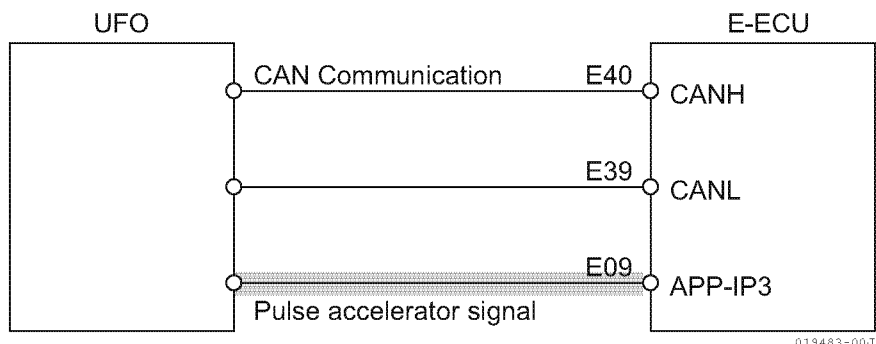
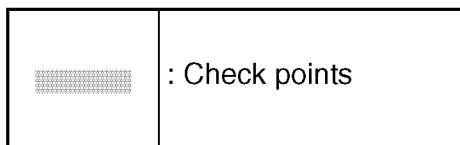

*For the E-ECU Pin Layout, see [E-ECU Pin Layout Diagram] (P.1-134).

Work Description

1. Harness continuity check:

- Remove the source unit of the pulse accelerator signal and E-ECU from the harness.
- Check the harness continuity using a circuit tester.

Terminal	Continuity	Status
Pulse accelerator signal wire E09 [Between E-ECU and source units]	Available	OK: normal
	Unavailable	NG: harness disconnection
Between E09 and other terminal/GND	Unavailable	OK: normal
	Available	NG: harness short-circuited with GND

NG	<ul style="list-style-type: none"> • Check if the harness is damaged, or if the wiring is correct. • Replace the harness.
OK	<ul style="list-style-type: none"> • Check the source unit of the pulse accelerator signal. • Replace the E-ECU.

ECU Temperature Sensor

Related DTC

DTC	P0668/4	Failure with ECU Temperature Sensor (Low Voltage)
	P0669/3	Failure with ECU Temperature Sensor (High Voltage)
	P1644/2	Intermittent Failure WITH ECU Temperature Sensor

Work flow

*For details of the work, see after-mentioned "<Work Description>." For the operation of the diagnosis tool, see "Diagnosis tool Operation Manual" separately.

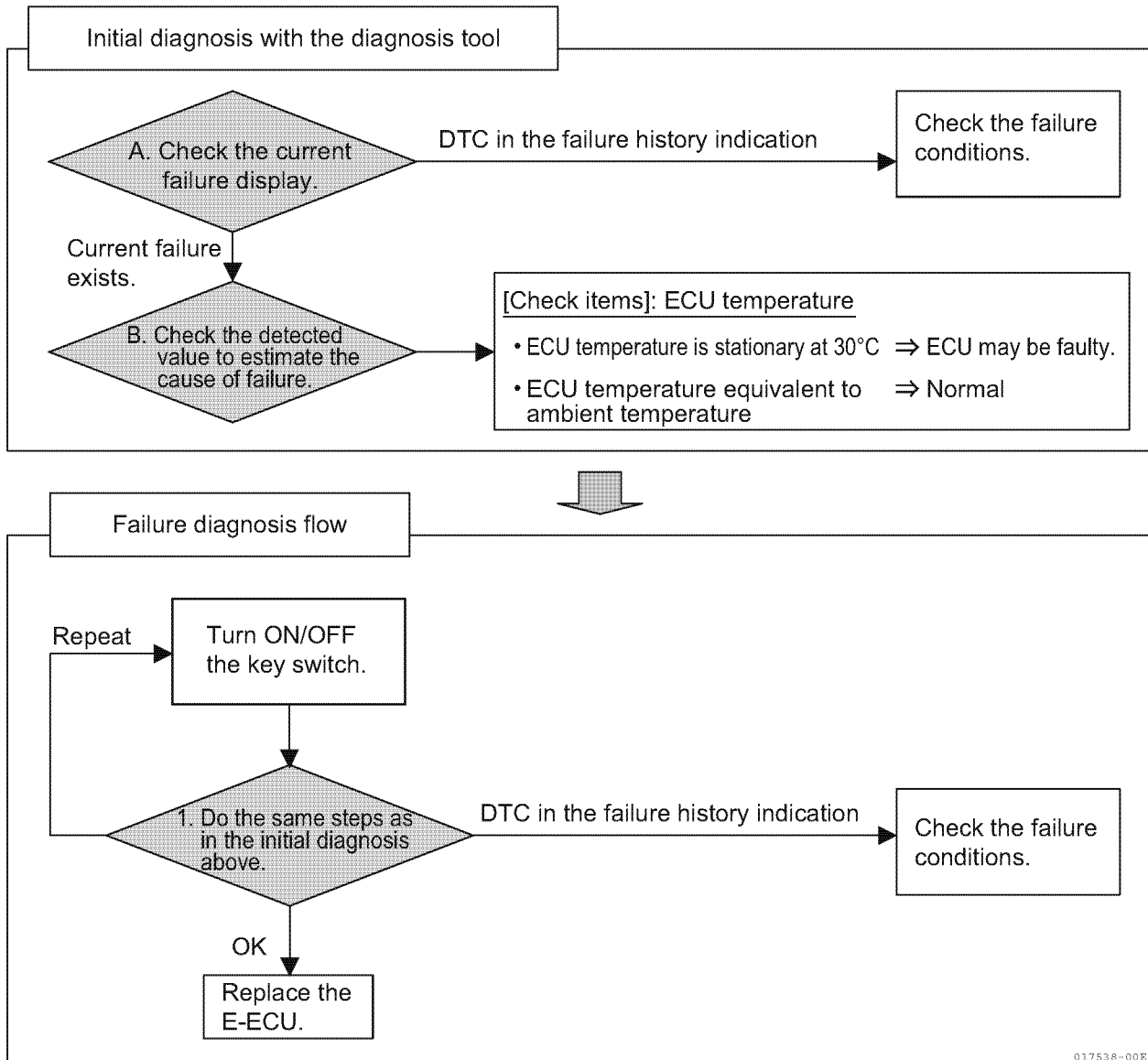

Work Description

1. Work with the diagnosis tool:

- Check of current failure indication
- Turn the key switch off, and turn the key switch on again.
- Connect the diagnosis tool, and check if any error is detected on the current fault indication.

Unavailable	Check the error history indication, confirm error occurrence situation if any error history is indicated.
Available	Check the detected value using the diagnosis tool. → Go to [• Check of detected value]

- Check of detected value
- Check the value indicated in the “E-ECU Temperature” with the diagnosis tool “Diagnosis Test” function.

Indicated value	Status	Action
Fixed at 30°C	NG	Replace the E-ECU.
Ambient temperature	OK	Replace the E-ECU.

NG	Replace E-ECU.
OK	Turn the key switch on/off again, and perform the work [• Check of current failure indication] [• Check of detected value]. Replace E-ECU.

Cooling water temperature sensor

Related DTC

DTC	P0117/4	Failure with Cooling Water Temperature Sensor (Low Voltage)
	P0118/3	Failure with Cooling Water Temperature Sensor (High Voltage)
	P0119/2	Intermittent Failure with Cooling Water Temperature Sensor

Work flow

*For details of the work, see after-mentioned "<Work Description>."For the operation of the diagnosis tool, see "Diagnosis tool Operation Manual" separately.

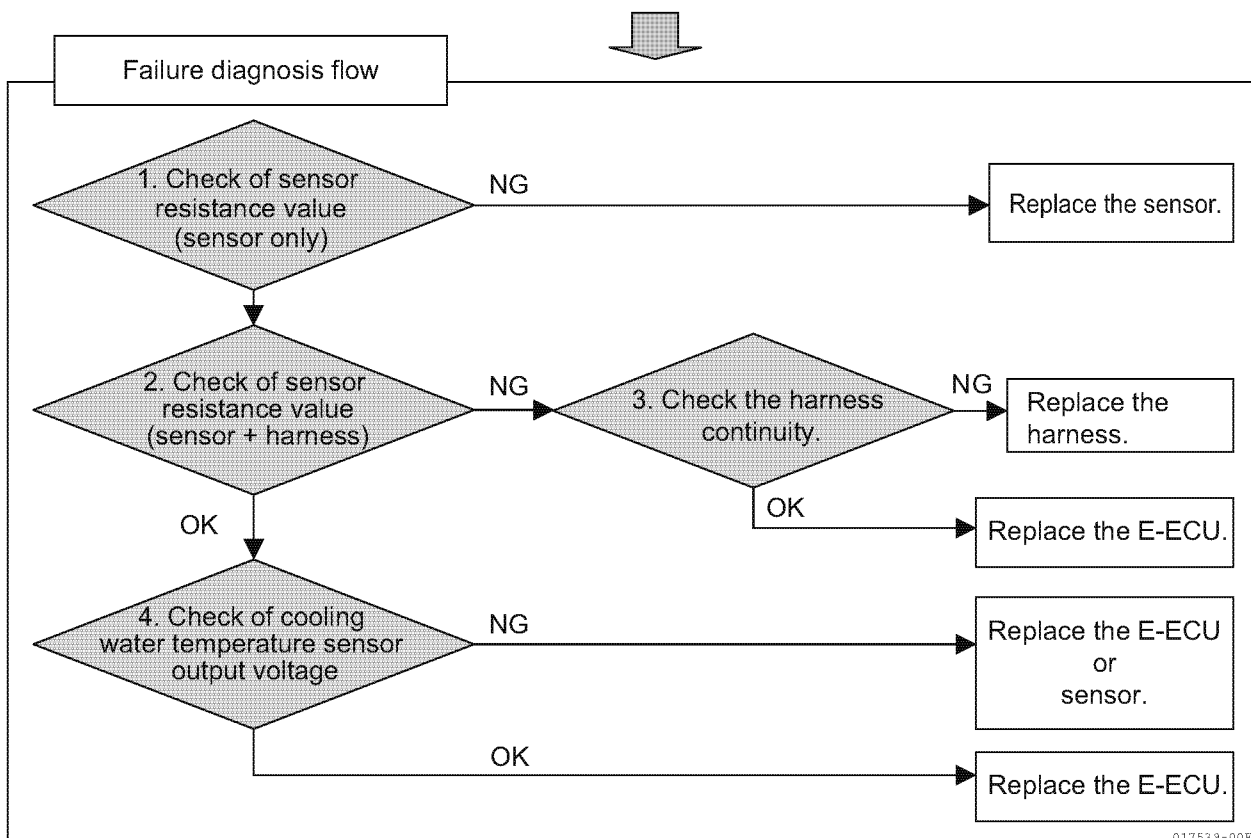
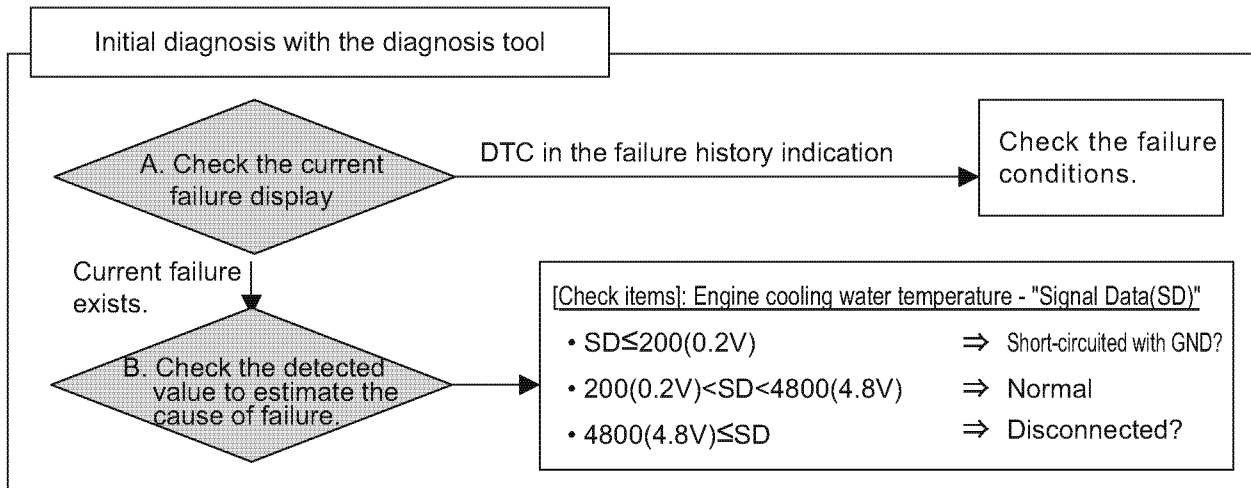

017539-00B

View of the sensor

*High-precision cooling water temperature sensor and conventional cooling water temperature sensor share similar construction.

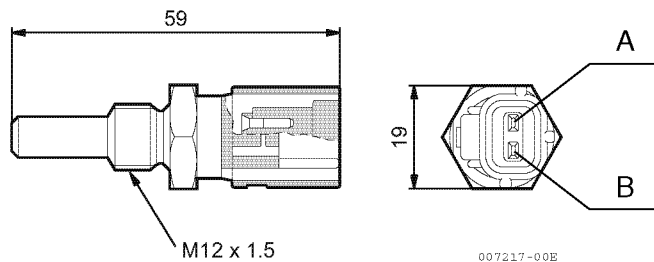

* High-precision cooling water temperature sensor and conventional cooling water temperature sensor have similar construction.

Wiring Diagram

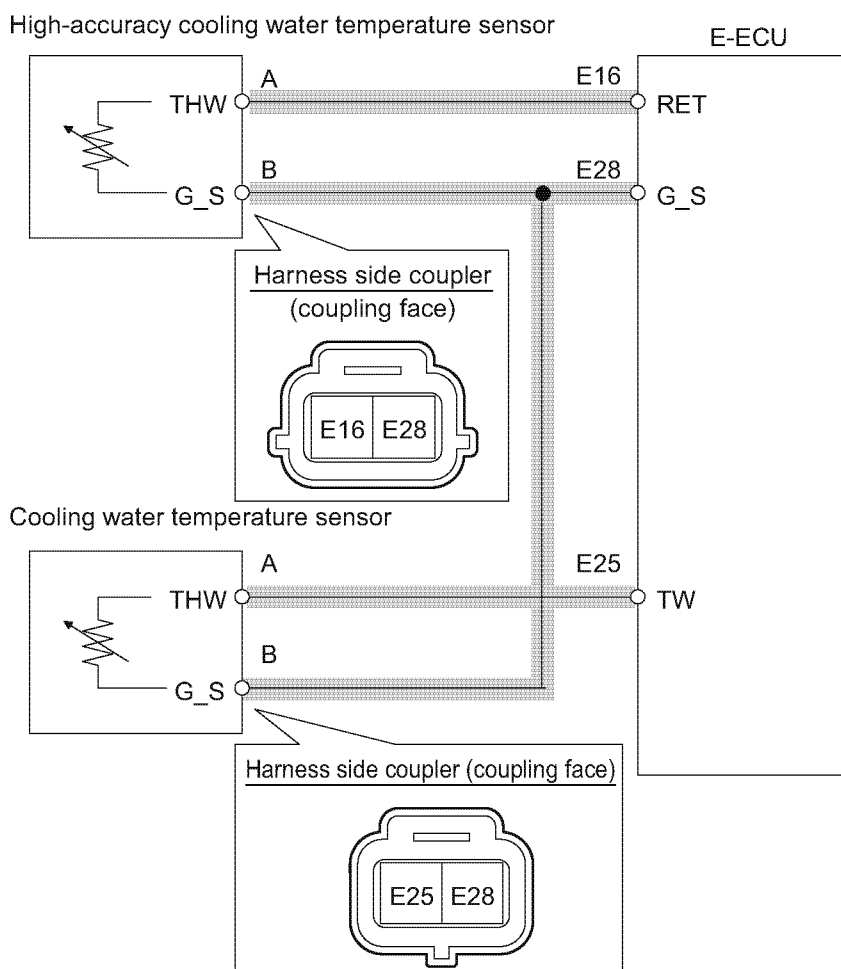
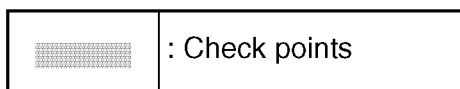

017540-00B

*For the E-ECU Pin Layout, see [E-ECU Pin Layout Diagram] (P.1-134).

Work Description

1. Check of the sensor resistance value (sensor only):

- Remove the harness from the cooling water temperature sensor.
- Measure the resistance between cooling water temperature sensor terminals A and B using a circuit tester.
- Check if the measured resistance value is within the normal range, referring to the following table <Characteristics of cooling water temperature sensor>.

<Characteristics of cooling water temperature sensor>

- Relationship between cooling water temperature and sensor resistance

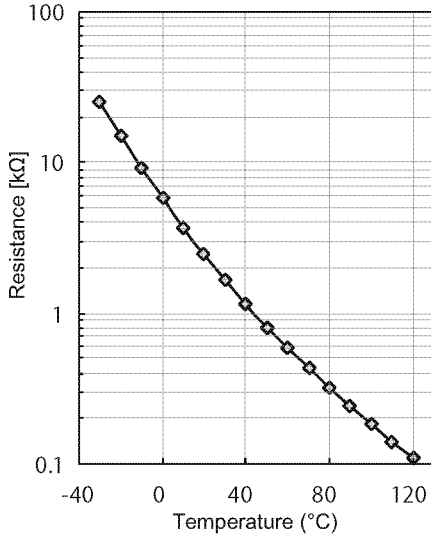

High-accuracy cooling water temperature sensor

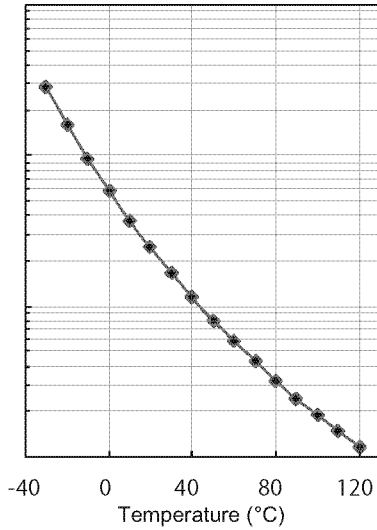

Conventional cooling water temperature sensor

Temperature (°C)	Resistance [kΩ]	
	High-precision	Conventional
-30	25.4	28.6
-20	15.04	16.2
-10	9.16	9.56
0	5.74	5.88
10	3.7	3.73
20	2.45	2.45
30	1.66	1.65
40	1.15	1.14
50	0.811	0.808
60	0.584	0.584
70	0.428	0.43
80	0.318	0.322
90	0.24	0.245
100	0.1836	0.189
110	0.1417	0.148
120	0.1108	0.117

NG	Replace the cooling water temperature sensor.
OK	Check the sensor resistance with the sensor and the harness being connected. → Go to [2. Check of the sensor resistance value (sensor + harness):]

2. Check of the sensor resistance value (sensor + harness):

- Connect the cooling water temperature sensor and the harness, and remove E-ECU from the harness.
- Measure the resistance between harness side E-ECU connector terminals E16 (E25) and E28 using a circuit tester.
- Check if the measured resistance value is within the normal range, referring to the above table <Characteristics of cooling water temperature sensor>.

NG	Check the harness for correct continuity. → Go to [3. Check of harness continuity:]
OK	Check the output voltage of the cooling water temperature sensor. → Go to [4. Output voltage check of the cooling water temperature sensor:]

3. Check of harness continuity:

- Remove the cooling water temperature sensor and E-ECU from the harness.
- Check the harness continuity using a circuit tester.

Terminal	Continuity	Status
Sensor signal wire E16 (E25) [E-ECU ñ between sensor connector]	Available	OK: normal
	Unavailable	NG: harness disconnection
Sensor GND wire E28 [Between E-ECU and sensor connector]	Available	OK: normal
	Unavailable	NG: harness disconnection
Between E16 and other terminal/GND (between E25 and other terminal/GND)	Unavailable	OK: normal
	Available	NG: harness short-circuited with GND
E28 ñ GND/E45/E47	Available	OK: normal
	Unavailable	NG: harness disconnection
Between E28 and other terminals	Unavailable	OK: normal
	Available	NG: harness short-circuited with another wiring

NG	<ul style="list-style-type: none"> • Check if the harness is damaged, or if the wiring is correct. • Replace the harness.
OK	Check the output voltage of the cooling water temperature sensor. → Go to [4. Output voltage check of the cooling water temperature sensor:]

4. Output voltage check of the cooling water temperature sensor:

- Connect the 2G eco-checker harness between E-ECU and machine's harness (for details, see[How to use the 2G eco-checker harness] (P.1-135). And connect the all connectors (sensors, E-ECU).
- Measure the voltage between sensor signal E16 and E28 (E35 and E28) using a circuit tester.

Voltage	Status	Action
$E16(E25) \leq 0.2[V]$	NG	<ul style="list-style-type: none"> • Replace the harness. • Replace the cooling water temperature sensor.
$0.2[V] < E16(E25) < 4.8V$	OK (Normal range)	ReplaceE-ECU.
$4.8V \leq E16(E25)$	NG	<ul style="list-style-type: none"> • Replace the harness. • Replace the cooling water temperature sensor.

NG	<ul style="list-style-type: none"> • Check if the harness is damaged, or if the wiring is correct. • Replace the harness.
OK	ReplaceE-ECU.

SENSOR 5V

Related DTC

DTC	P0642/4	Failure with SENSOR 5V (Low Voltage)
	P0643/3	Failure with SENSOR 5V (High Voltage)
	P1644/2	Intermittent Failure with SENSOR 5V

Work flow

*For details of the work, see after-mentioned "<Work Description>." For the operation of the diagnosis tool, see "Diagnosis tool Operation Manual" separately.

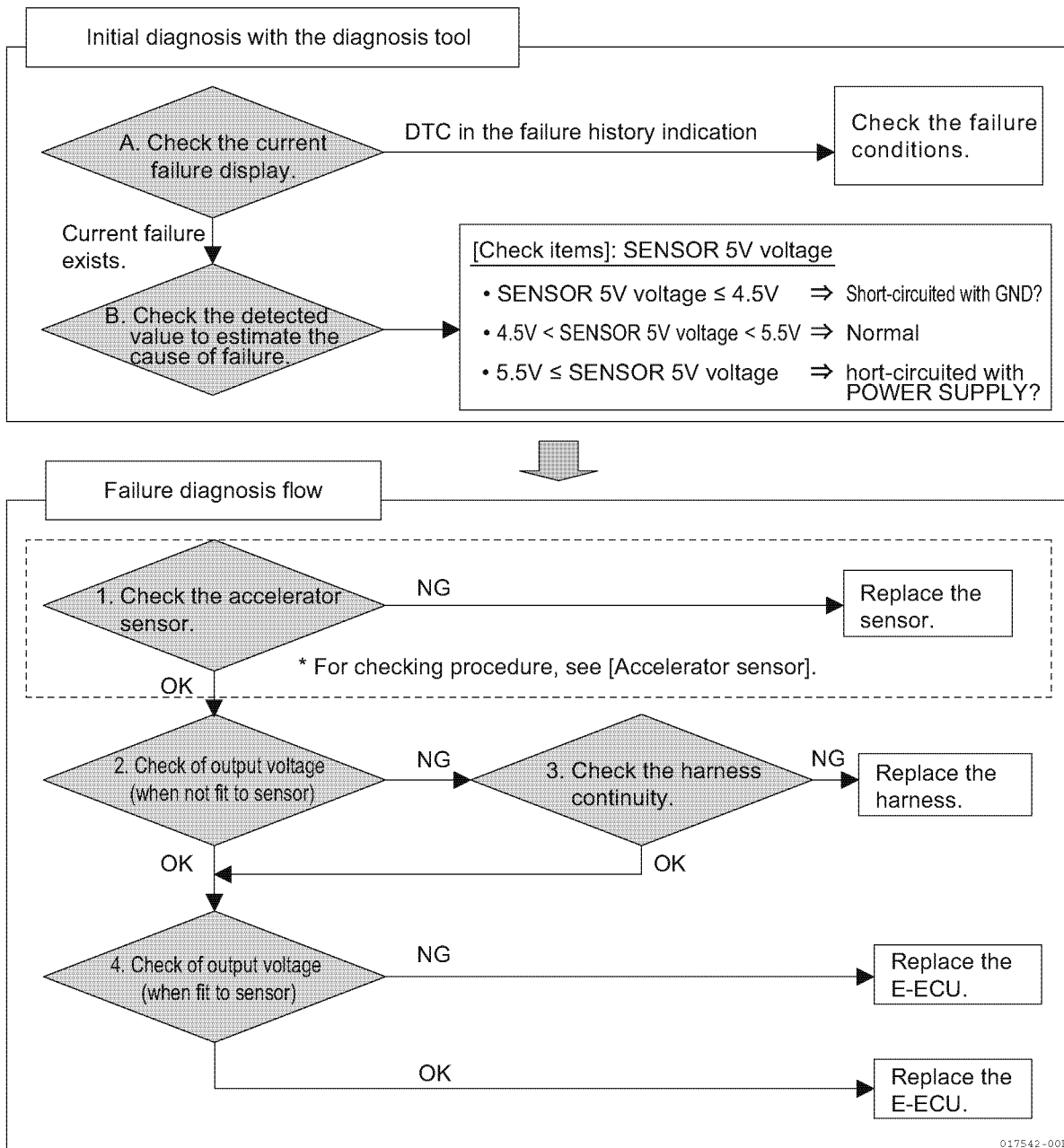

Work Description

1. Check of the accelerator sensor:
 - For details, see[Accelerator sensor] (P.1-12).
2. Check of the output voltage (not fit with sensor):
 - Remove the harness from the accelerator sensor. At this time, keep the E-ECU connector being connected to E-ECU.
 - Turn the key switch on to turn on the E-ECU power.
 - Measure the voltage between the harness side accelerator sensor connector terminals E38 and GND using a circuit tester.

Terminal	Normal value
Sensor connector E38 - GND	5V

NG	Check the harness for correct continuity. → Go to [3. Check of harness continuity:]
OK	Check the output voltage with the accelerator sensor being connected. → Go to [4. Check of the output voltage (fit with sensor):]

3. Check of harness continuity:
 - Remove the harness from the accelerator sensor and E-ECU.
 - Check the harness continuity using a circuit tester.

Terminal	Continuity	Status
Between E38 and E28/E45/E47/GND	Unavailable	OK: normal
	Available	NG: harness short-circuited with GND
Between E38 and E43/E48	Unavailable	OK: normal
	Available	NG: Harness short-circuited with power supply
Sensor GND wire E28 Between E-ECU and sensor connector	Available	OK: normal
	Unavailable	NG: harness disconnection
Between E28 and GND/E45/E47	Available	OK: normal
	Unavailable	NG: harness disconnection
Between E38/E28 and other terminals	Unavailable	OK: normal
	Available	NG: harness short-circuited with another wiring

NG	<ul style="list-style-type: none"> • Check if the harness is damaged, or if the wiring is correct. • Replace the harness.
OK	Check the output voltage with the accelerator sensor being connected. → Go to [4. Check of the output voltage (fit with sensor):]

4. Check of the output voltage (fit with sensor):

- Connect the 2G eco-checker harness between E-ECU and machine's harness (for details, see [How to use the 2G eco-checker harness] (P.1-135). And connect the all connectors (sensors, E-ECU).
- Measure the voltage between sensor signal E38 and E28 using a circuit tester.

Voltage	Status	Action
$E38 \leq 4.5[V]$	NG	<ul style="list-style-type: none"> • Replace the harness. • Replace the accelerator sensor.
$4.5[V] < E38 < 5.5[V]$	OK (Normal range)	Replace E-ECU.
$5.5[V] \leq E38$	NG	<ul style="list-style-type: none"> • Replace the harness. • Replace the accelerator sensor.

NG	<ul style="list-style-type: none"> • Check if the harness is damaged, or if the wiring is correct. • Replace the harness.
OK	Replace E-ECU.

Pulse Sensor Related Failures

Speed Sensor

Related DTC

DTC	P0340/4	Speed Sensor Error
-----	---------	--------------------

Work flow

*For details of the work, see after-mentioned "<Work Description>."For the operation of the diagnosis tool, see "Diagnosis tool Operation Manual" separately.

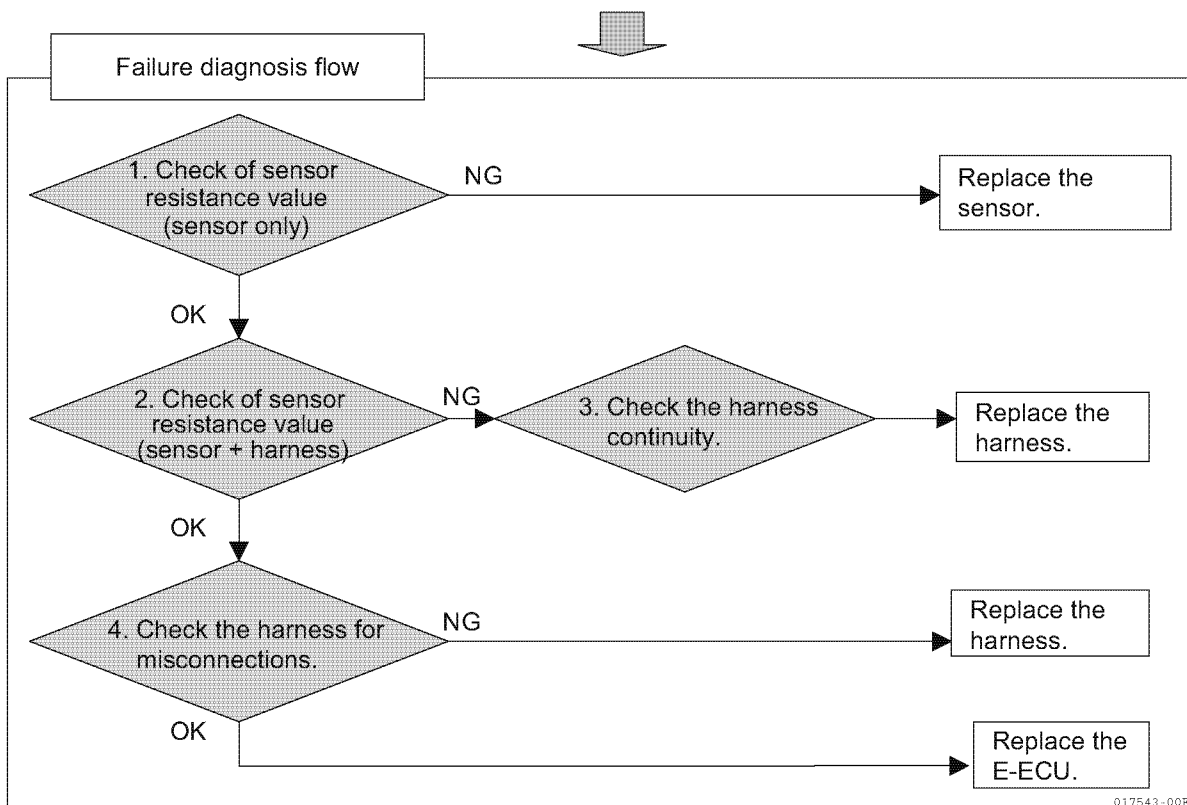
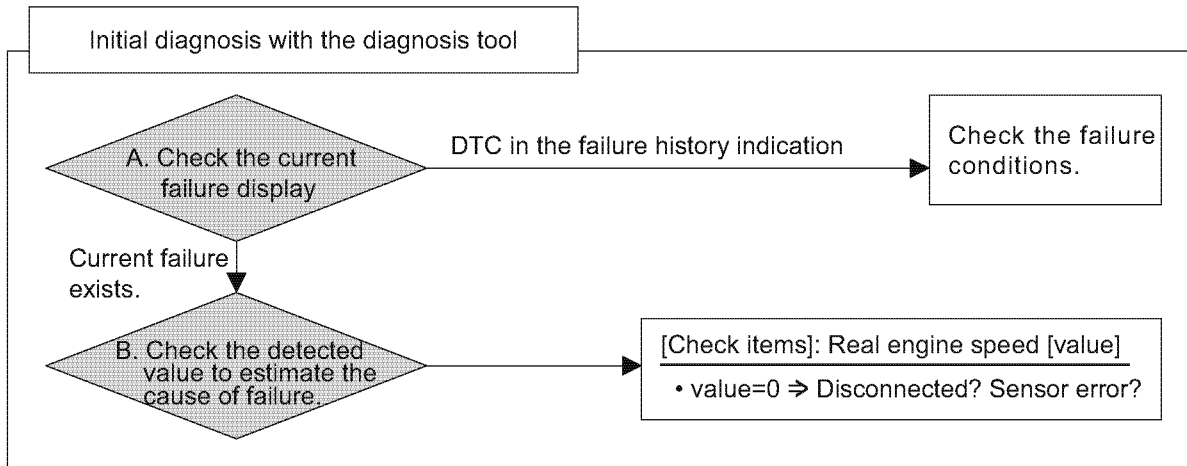

017543-00B

Wiring Diagram

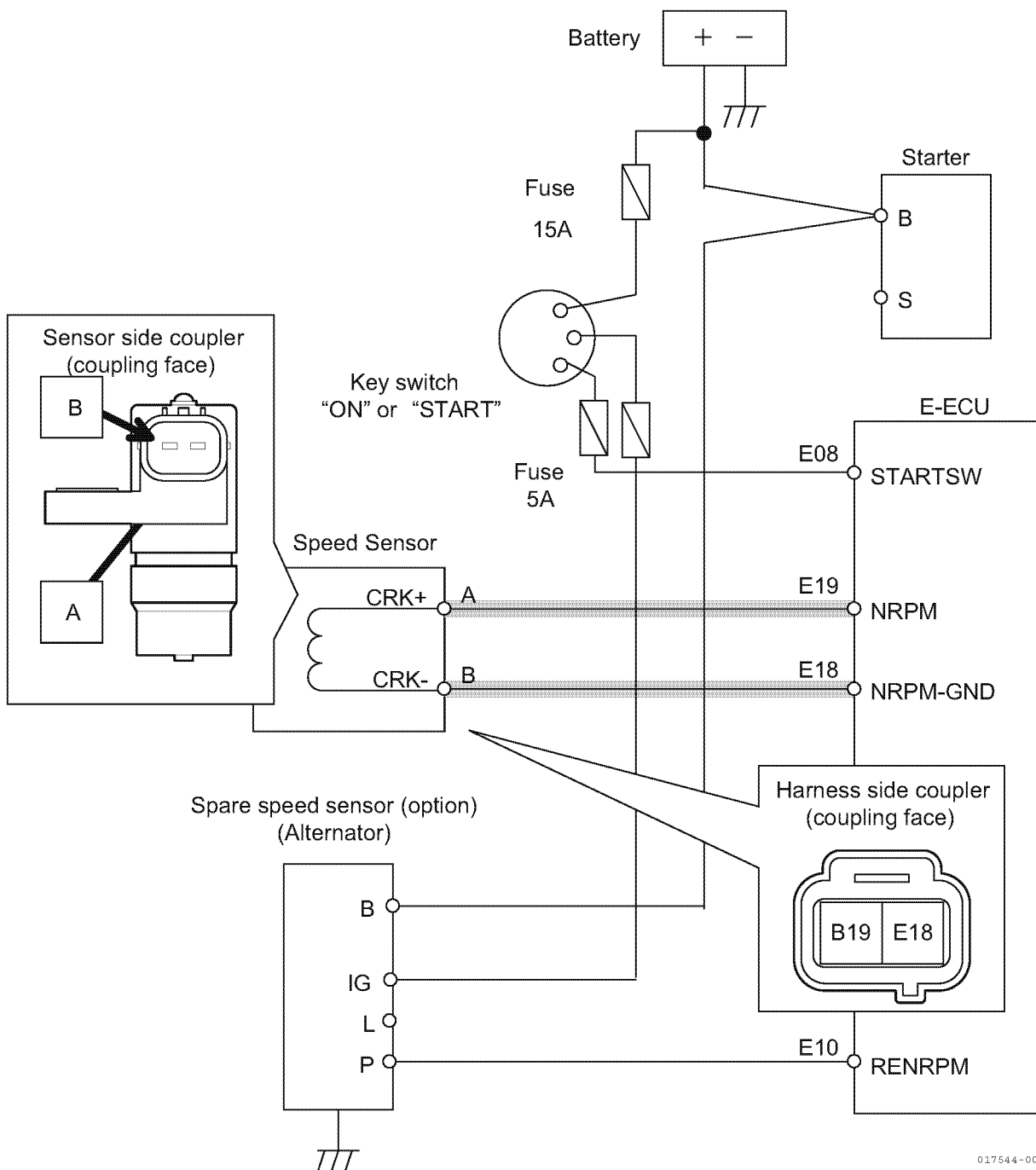
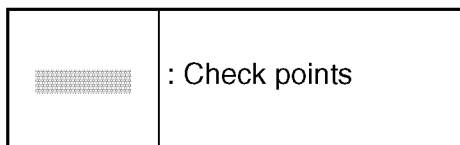

017544-00E

*For the E-ECU Pin Layout, see [E-ECU Pin Layout Diagram] (P.1-134)

Work Description

1. Check of the sensor resistance value (sensor only):

- Remove the harness from the speed sensor.
- Measure the resistance between speed sensor terminals A and B using a circuit tester.

(REF) Coil resistance value of Yanmar standard speed sensor

Terminal	Specification
Sensors A - B	500 ± 100Ω

NG	Replace the speed sensor.
OK	Check the resistance between sensor terminals A and B with the speed sensor and the harness being connected. → Go to [2. Check of the sensor resistance value (sensor + harness):]

2. Check of the sensor resistance value (sensor + harness):

- Connect the speed sensor and the harness, and remove E-ECU from the harness.
- Measure the resistance between harness side E-ECU connector terminals E19 and E18 using a circuit tester.
*See above-mentioned “(REF) Coil resistance of Yanmar standard speed sensors”.

NG	Replace the harness.
OK	Check the harness for correct continuity. → Go to [3. Check of harness continuity:]

3. Check of harness continuity:

- Remove the speed sensor and E-ECU from the harness.
- Check the harness continuity using a circuit tester.

Terminal	Continuity	Status
Sensor signal (+) wire E19 [Between E-ECU and sensor connector]	Available	OK: normal
	Unavailable	NG: harness disconnection
Sensor signal (-) wire E18 [Between E-ECU and sensor connector]	Available	OK: normal
	Unavailable	NG: harness disconnection
Between E19 and GND/E45/E47 (between E18 and GND/E45/E47)	Unavailable	OK: normal
	Available	NG: harness short-circuited with GND

NG	<ul style="list-style-type: none"> • Check if the harness is damaged, or if the wiring is correct. • Replace the harness.
OK	Replace E-ECU.

Spare speed sensor

Related DTC

DTC	P1340/4	Failure with Spare Speed Sensor
-----	---------	---------------------------------

Work flow

*For details of the work, see after-mentioned "<Work Description>." For the operation of the diagnosis tool, see "Diagnosis tool Operation Manual" separately.

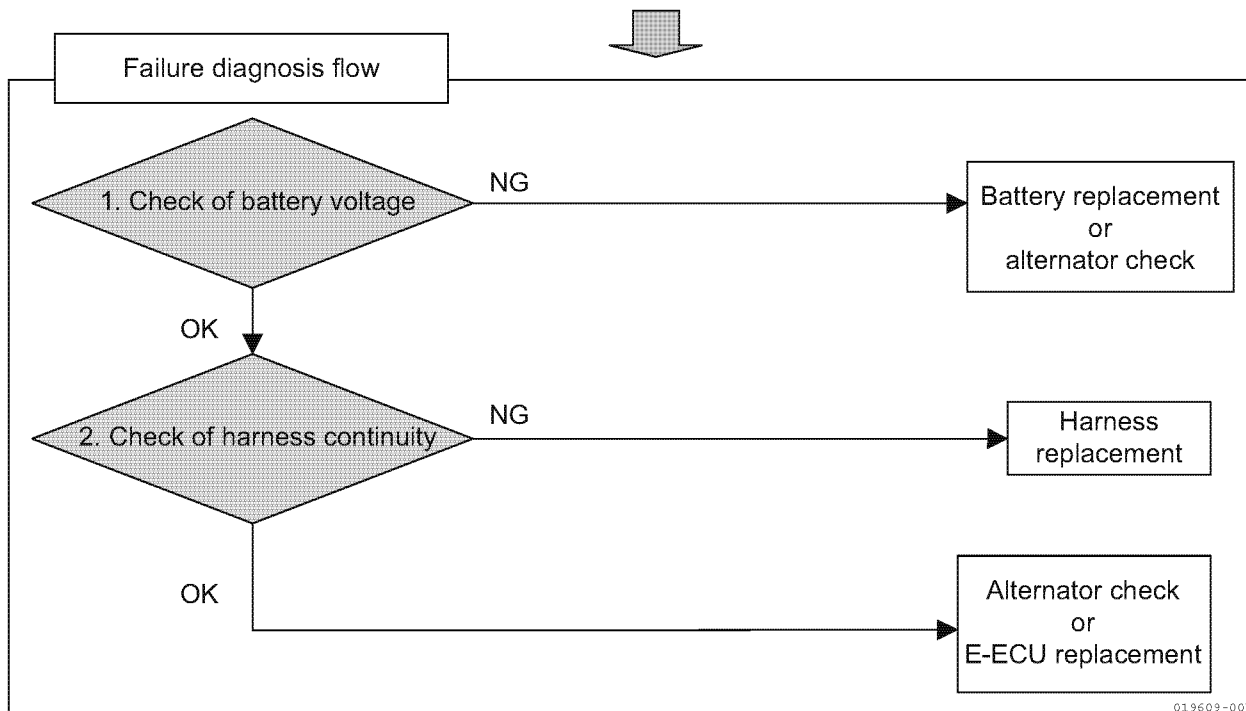
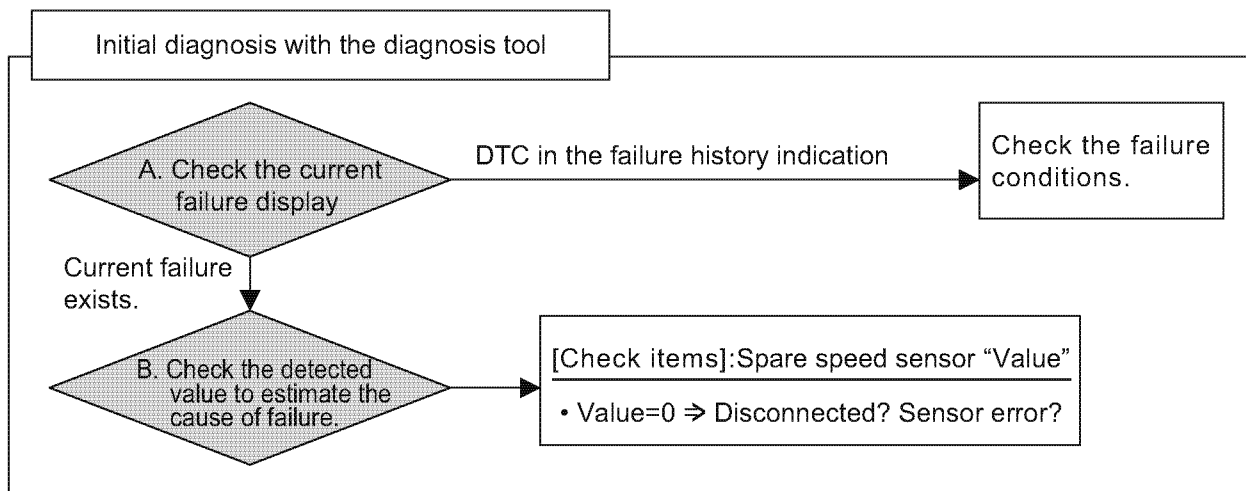

019609-00E

Wiring Diagram

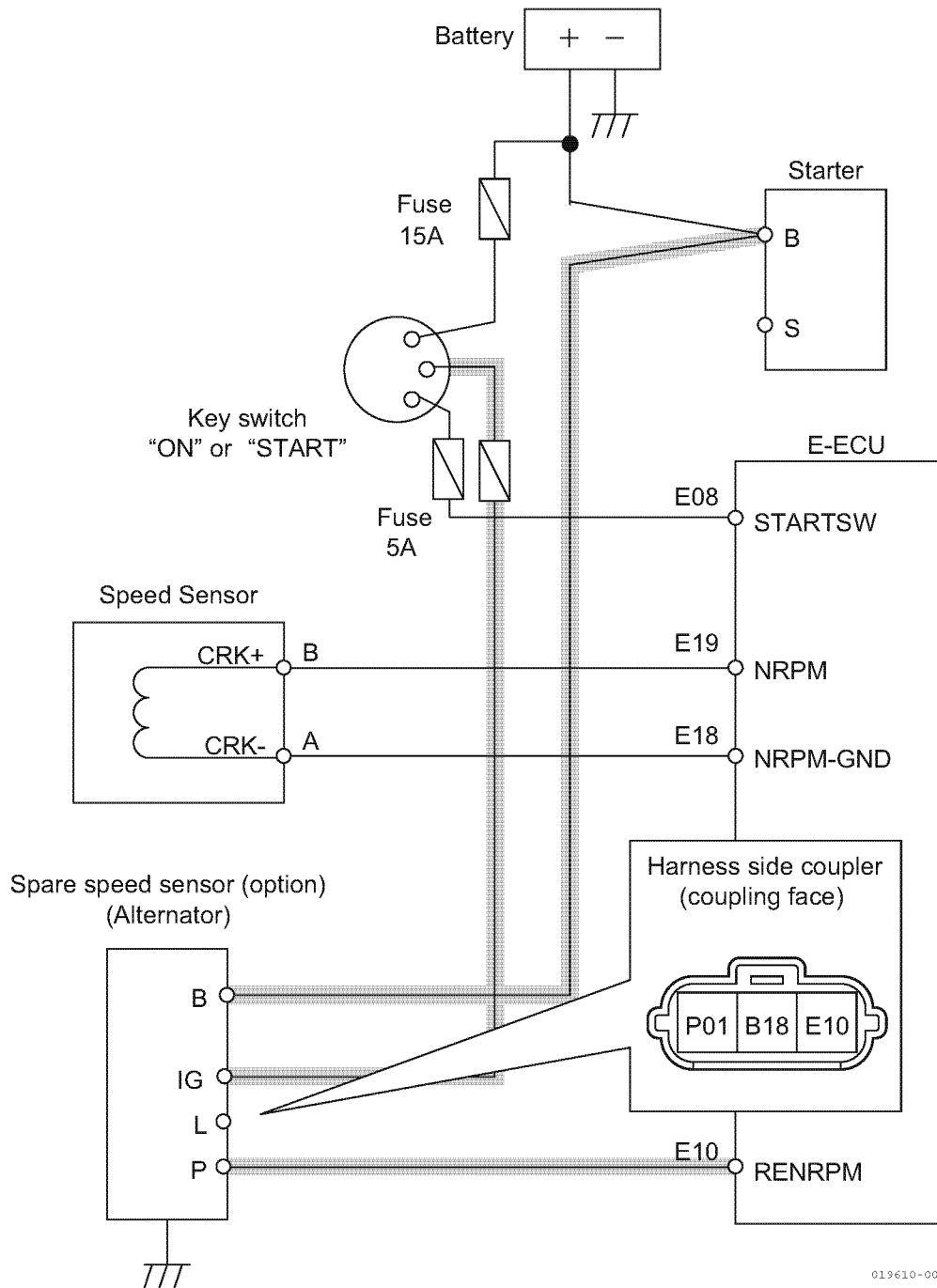
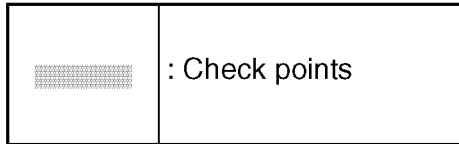

019610-00E

*For the E-ECU Pin Layout, see [E-ECU Pin Layout Diagram] (P.1-134).

Work Description

1. Battery voltage check:

- Set the accelerator at the lowest position, and operate the engine.
- Measure the battery voltage using a circuit tester.

Terminal	Specification
Battery voltage (in the normal condition)	10 to 16 [V]

NG	<ul style="list-style-type: none"> • Check the alternator. • Replace the battery.
OK	Check the harness for correct continuity. → Go to [2. Check of harness continuity:]

2. Check of harness continuity:

- Remove the connector of the spare speed sensor and E-ECU from the harness.
- Check the harness continuity using a circuit tester.

Terminal	Continuity	Status
Alternator P terminal (E10) [Between E-ECU and alternator]	Available	OK: normal
	Unavailable	NG: harness disconnection
Alternator IG terminal [Between Key switch and alternator]	Available	OK: normal
	Unavailable	NG: harness disconnection
Alternator B terminal [Between battery and alternator]	Available	OK: normal
	Unavailable	NG: harness disconnection
Between E10 and GND/E45/E47	Unavailable	OK: normal
	Available	NG: harness short-circuited with GND

NG	<ul style="list-style-type: none"> • Check if the harness is damaged, or if the wiring is correct. • Replace the harness.
OK	<ul style="list-style-type: none"> • Check the alternator. • Replace the E-ECU.

Contact Output Related Failures

RACK ACTUATOR RELAY

Related DTC

DTC	P1222/4	Failure A with Rack Actuator Relay
	P1223/3	Failure B with Rack Actuator Relay
	P1224/2	Intermittent Failure with Rack Actuator Relay

Work flow

*For details of the work, see after-mentioned "<Work Description>."For the operation of the diagnosis tool, see "Diagnosis tool Operation Manual" separately.

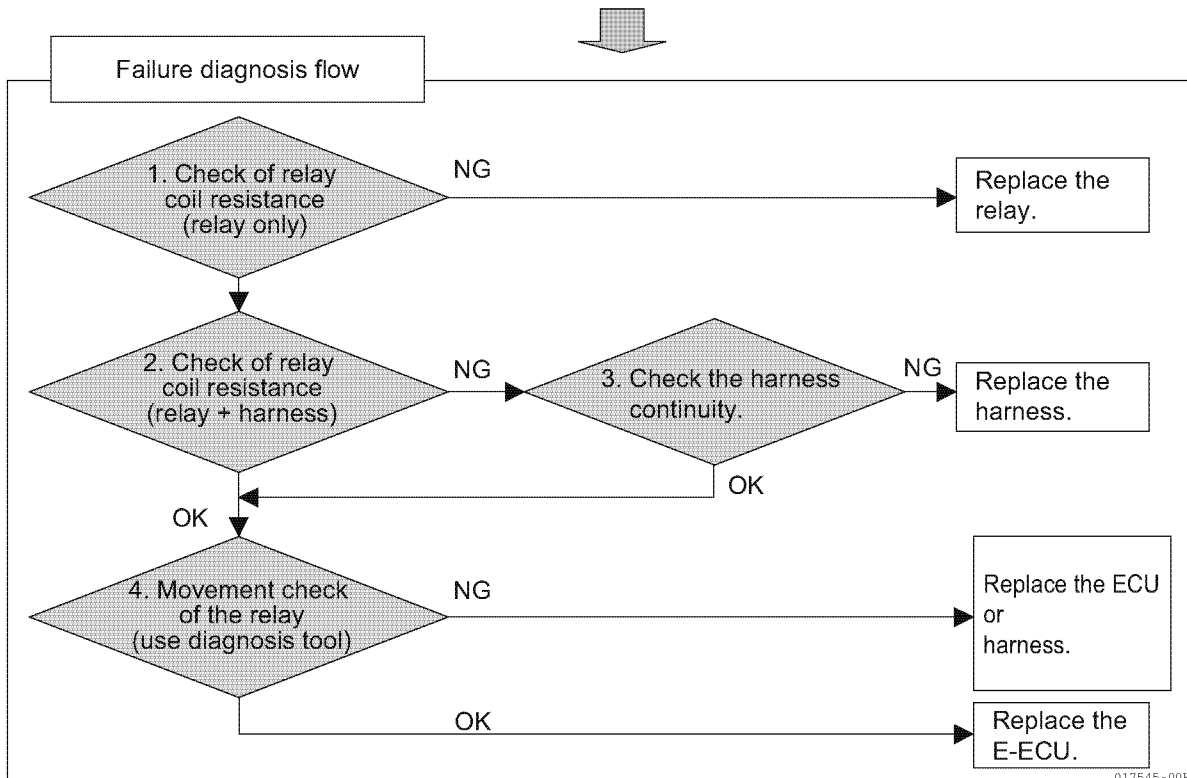
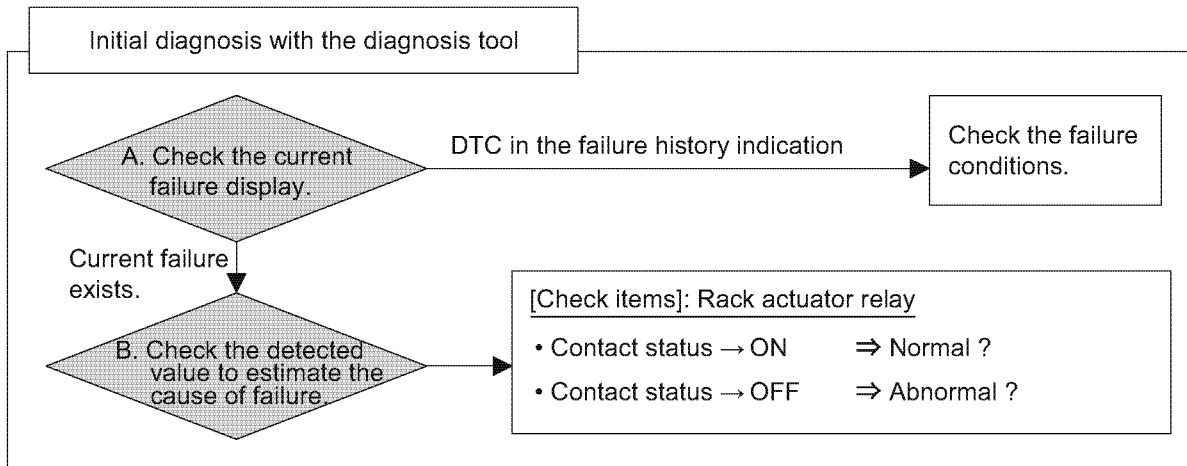

Wiring Diagram

 : Check points

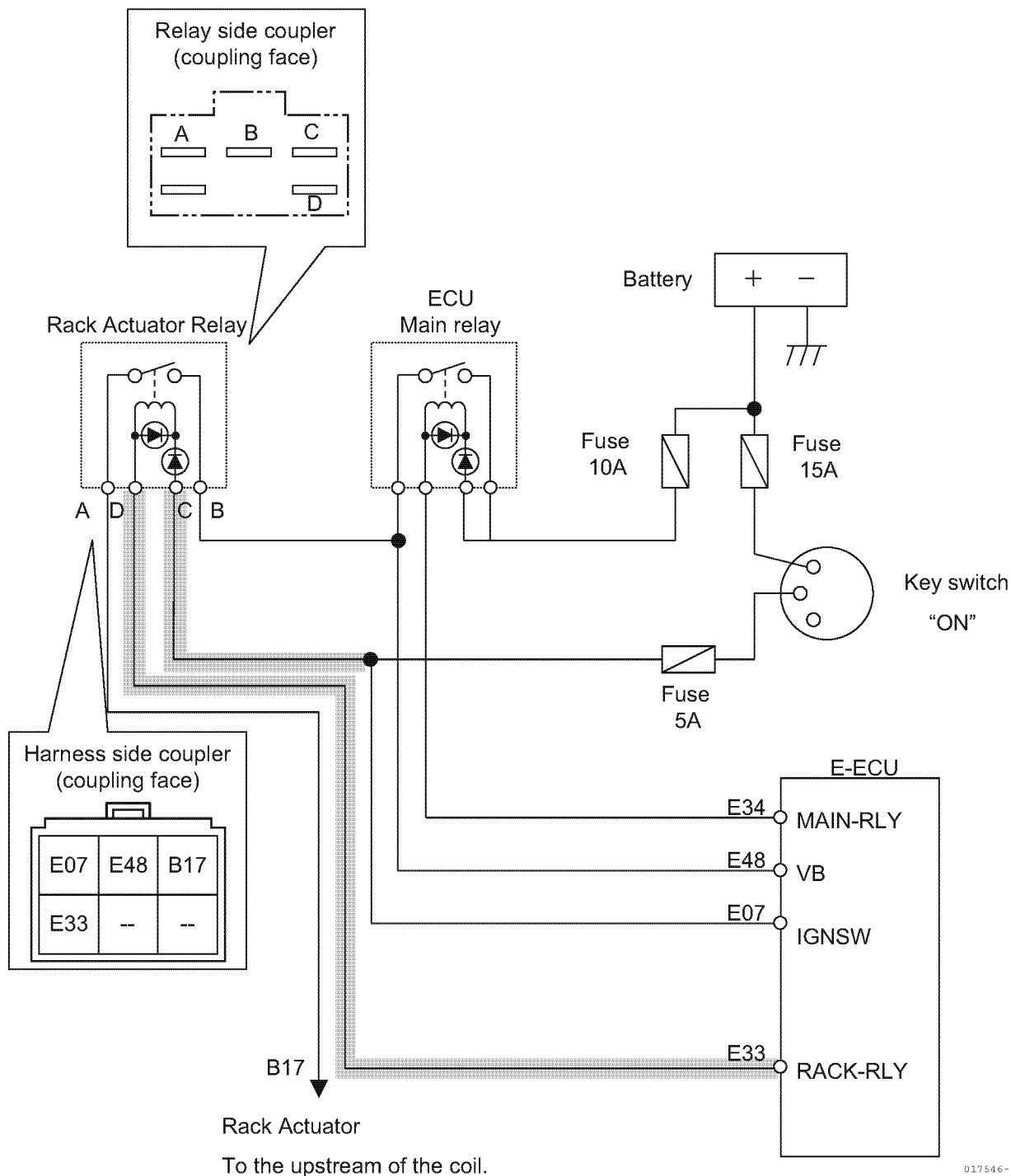

Work Description

1. Check of the relay coil resistance value (relay only):

- Remove the rack actuator relay from the harness.
- Measure the resistance between relay side terminals C and D using a circuit tester.

Measurement conditions		Measured value	Status
Tester (+) side	Tester (-) side		
Terminal C	Terminal D	Available (*)	OK when both are normal
Terminal D	Terminal C	Infinity (*)	
Terminal C	Terminal D	Infinity (*)	NG: Fault of the relay internal circuitry
Terminal D	Terminal C		

*As a reverse-biased diode is integrated, the above-mentioned checking method is applied, and the measured value varies depending on a circuit tester to be used.

NG	Replace the rack actuator relay.
OK	Check the relay coil resistance with the rack actuator relay and the harness being connected. → Go to [2. Check of the relay coil resistance value (relay + harness side):]

2. Check of the relay coil resistance value (relay + harness side):

- Install the rack actuator relay to the harness.
- Remove E-ECU from the harness.
- Measure the resistance between E-ECU connectors E07 and E33 using a circuit tester.

Measurement conditions		Measured value	Status
Tester (+) side	Tester (-) side		
E07	E33	Available (*)	OK: normal
E33	E07	Infinity (*)	
E07	E33	Infinity (*)	NG: Harness error
E33	E07		

*As a reverse-biased diode is integrated, the above-mentioned checking method is applied, and the measured value varies depending on a circuit tester to be used.

NG	Check the harness for correct continuity. → Go to [3. Check of harness continuity:]
OK	Check the movement of the rack actuator relay by the diagnosis tool. → Go to [4. Movement check of the relay:]

3. Check of harness continuity:

- Remove the rack actuator relay from the harness, and remove E-ECU from the harness.
- Check the harness continuity using a circuit tester.

Terminal	Continuity	Status
Relay coil (downstream side) E33 [Between E-ECU and sensor connector]	Available	OK: normal
	Unavailable	NG: harness disconnection
Relay coil (upstream side) E07 [Between E-ECU and sensor connector]	Available	OK: normal
	Unavailable	NG: harness disconnection
Between E33 and GND/E28/E45/E47	Unavailable	OK: normal
	Available	NG: harness short-circuited with GND
Between E33 and E43/E48	Unavailable	OK: normal
	Available	NG: Harness short-circuited with power supply

NG	<ul style="list-style-type: none"> • Check if the harness is damaged, or if the wiring is correct. • Replace the harness.
OK	Check the movement of the rack actuator relay by the diagnosis tool. → Go to [4. Movement check of the relay:]

4. Movement check of the relay:

- Connect the 2G eco-checker harness between E-ECU and machine's harness (for details, see [How to use the 2G eco-checker harness] (P.1-135). And connect the all connectors (rack actuator relay, E-ECU).
- Connect the diagnosis tool, and log in to the diagnosis tool after key switch turning-on.
- Activate the rack actuator relay by the diagnosis tool "Diagnosis Test: Active control", and measure the voltage between terminals E33 and E45.

ON/OFF setting status	Voltage	Status
ON	1.75[V] and below	OK: normal
	Over 1.75[V]	NG: Harness short-circuited with power supply or E-ECU fault
OFF	2.5[V] and above	OK: normal
	Under 2.5[V]	NG: Harness short-circuited with GND or E-ECU fault

NG	<ul style="list-style-type: none"> • Check if the harness is damaged, or if the wiring is correct. • Replace the harness.
OK	Replace the E-ECU.

START ASSIST RELAY

Related DTC

DTC	P1232/4	Failure A with Start Assist Relay
	P1233/3	Failure B with Start Assist Relay
	P1234/2	Intermittent Failure with Start Assist Relay

Work flow

*For details of the work, see after-mentioned "<Work Description>." For the operation of the diagnosis tool, see "Diagnosis tool Operation Manual" separately.

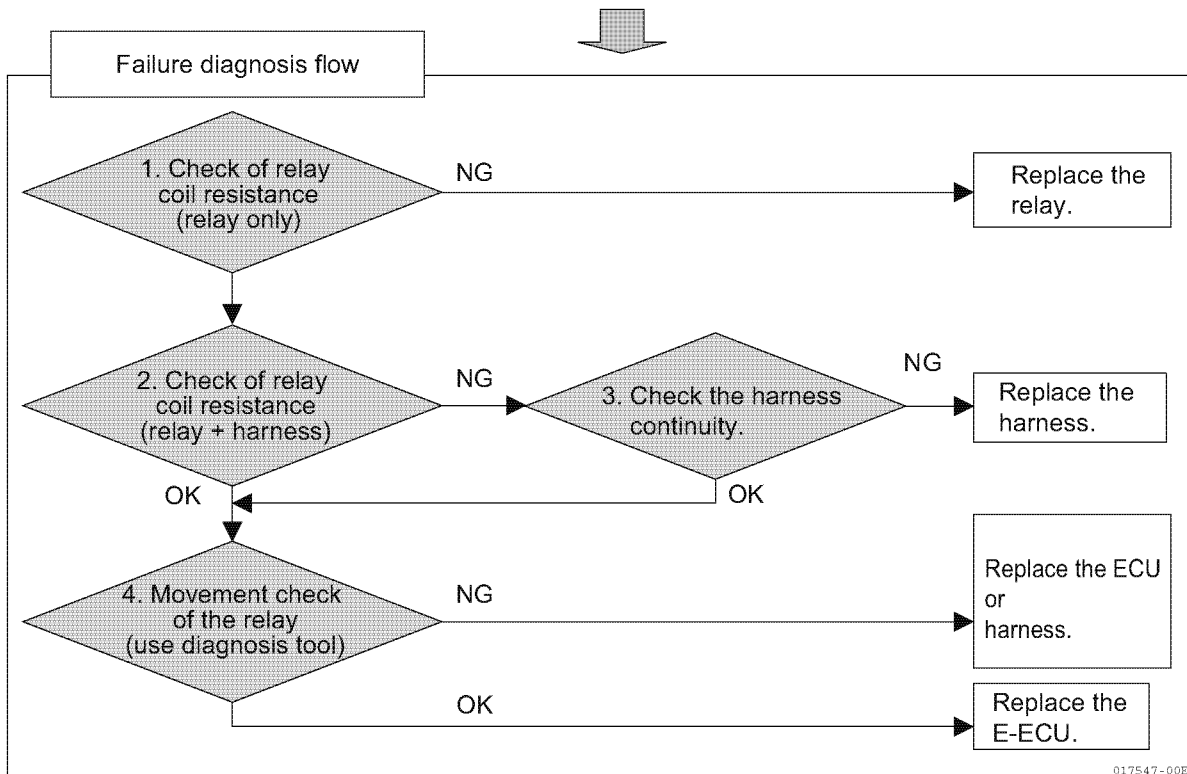
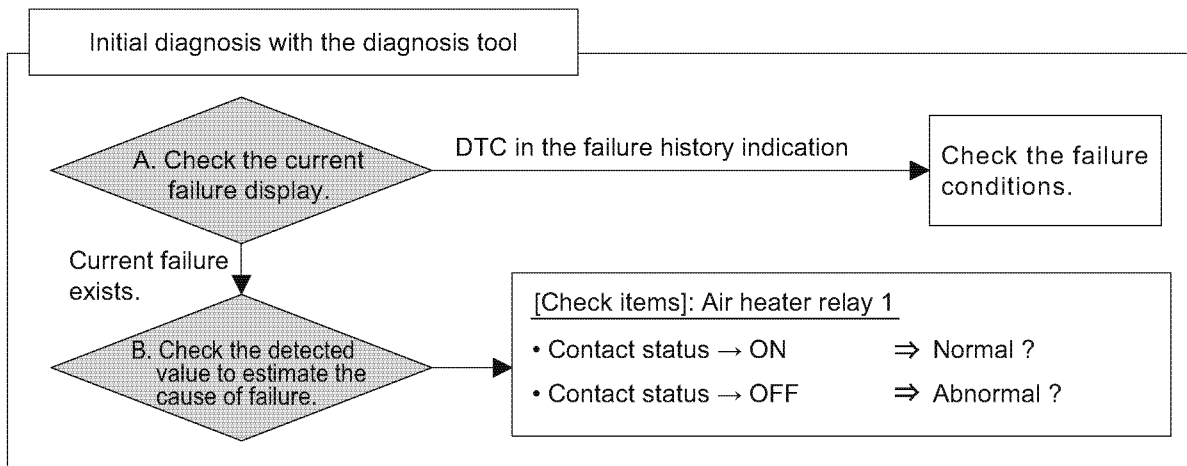

017547-00B

Wiring Diagram

 : Check points

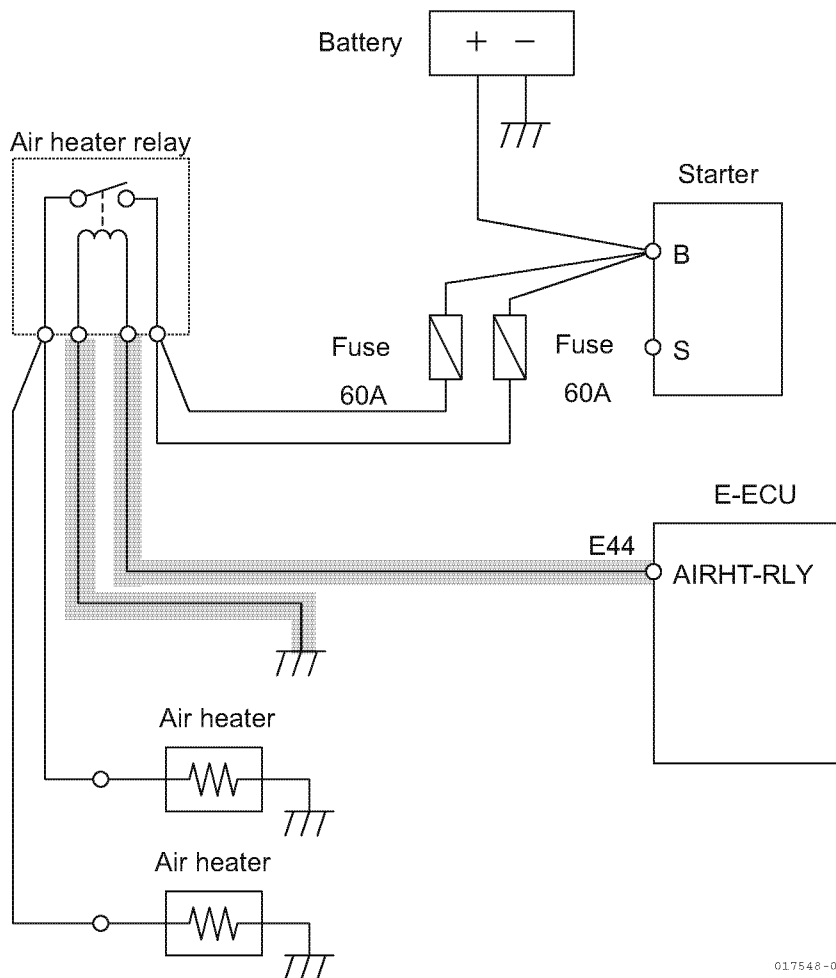

017548-00E

Harness side coupler

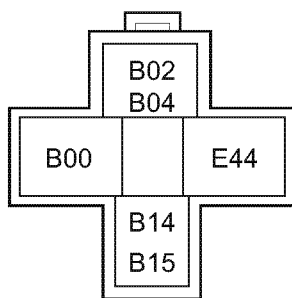

(coupling face)

017549-00E

*For the E-ECU Pin Layout, see [E-ECU Pin Layout Diagram] (P.1-134).

Work Description

1. Check of the relay coil resistance value (relay only):

- Remove the start assist relay from the harness.
- Measure the resistance between relay side terminals C and D using a circuit tester.

(REF) The resistance value of Yanmar standard start assist relay

Terminal	Specification
Relay coil side C - D (40A relay)	103Ω ± 10% (at 20°C)
Relay coil side C - D (70A relay)	103Ω ± 10% (at 20°C)
Relay coil side C - D (90A relay)	80Ω (at 20°C)

NG	Replace the start assist relay.
OK	Check the relay coil resistance with the start assist relay and the harness being connected. → Go to [2. Check of relay coil resistance value (relay + harness side):]

2. Check of relay coil resistance value (relay + harness side):

- Install the start assist relay to the harness.
- Remove E-ECU from the harness.
- Measure the resistance between E-ECU connectors E44 and B00 using a circuit tester.
*See above-mentioned “(REF) Resistance of Yanmar standard start assist relay”.

NG	Check the harness for correct continuity. → Go to [3. Check of harness continuity:]
OK	Check the movement of the start assist relay by a diagnosis tool. → Go to [4. Movement check of the relay:]

3. Check of harness continuity:

- Remove the start assist relay from the harness, and remove E-ECU from the harness.
- Check the harness continuity using a circuit tester.

Terminal	Continuity	Status
Relay coil (upstream side) E44 [Between E-ECU and sensor connector]	Available	OK: normal
	Unavailable	NG: harness disconnection
Relay coil (downstream side) B00 [Between E-ECU and sensor connector]	Available	OK: normal
	Unavailable	NG: harness disconnection
Between E33 and GND/E28/E45/E47	Unavailable	OK: normal
	Available	NG: harness short-circuited with GND
Between E44 and E43/E48	Unavailable	OK: normal
	Available	NG: Harness short-circuited with power supply

NG	<ul style="list-style-type: none"> • Check if the harness is damaged, or if the wiring is correct. • Replace the harness.
OK	Check the movement of the rack actuator relay by the diagnosis tool. → Go to [4. Movement check of the relay:]

4. Movement check of the relay:

- Connect the 2G eco-checker harness between E-ECU and machine's harness (for details, see [How to use the 2G eco-checker harness] (P.1-135). And connect the all connectors (start assistant relay, E-ECU).
- Connect the diagnosis tool, and log in to the diagnosis tool after key switch turning-on.
- Activate the start assistant relay by the diagnosis tool "Diagnosis Test: Active control", and measure the voltage between terminals E44 and E45.

ON/OFF setting status	Voltage	Status
ON	2.5[V] and above	OK: normal
	Under 2.5[V]	NG: Harness short-circuited with GND or E-ECU fault
OFF	1.75[V] and below	OK: normal
	Over 1.75[V]	NG: Harness short-circuited with power supply or E-ECU fault

NG	<ul style="list-style-type: none"> • Check if the harness is damaged, or if the wiring is correct. • Replace the harness.
OK	Replace the E-ECU.

CSD Solenoid Valve Coil

Related DTC

DTC	P1242/4	Failure A with CSD Solenoid Valve
	P1243/3	Failure B with CSD Solenoid Valve
	P1244/2	Intermittent Failure with CSD solenoid valve

Work flow

*For details of the work, see after-mentioned "<Work Description>." For the operation of the diagnosis tool, see "Diagnosis tool Operation Manual" separately.

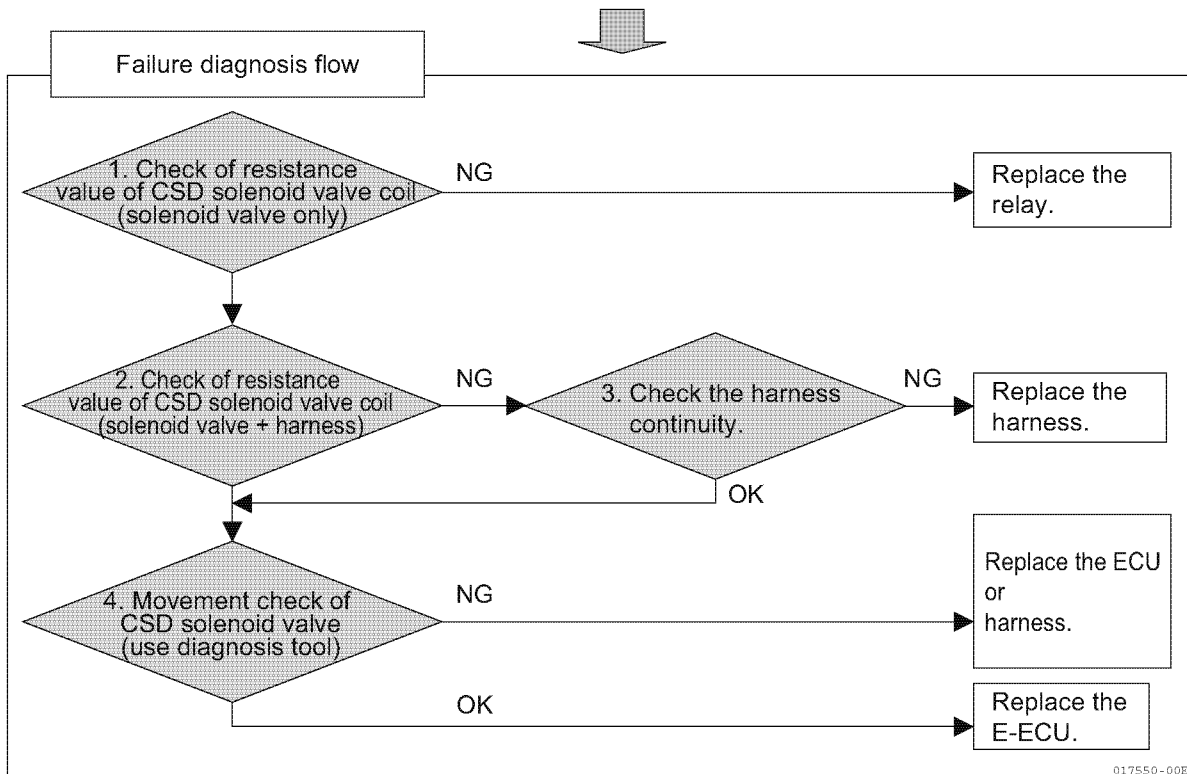
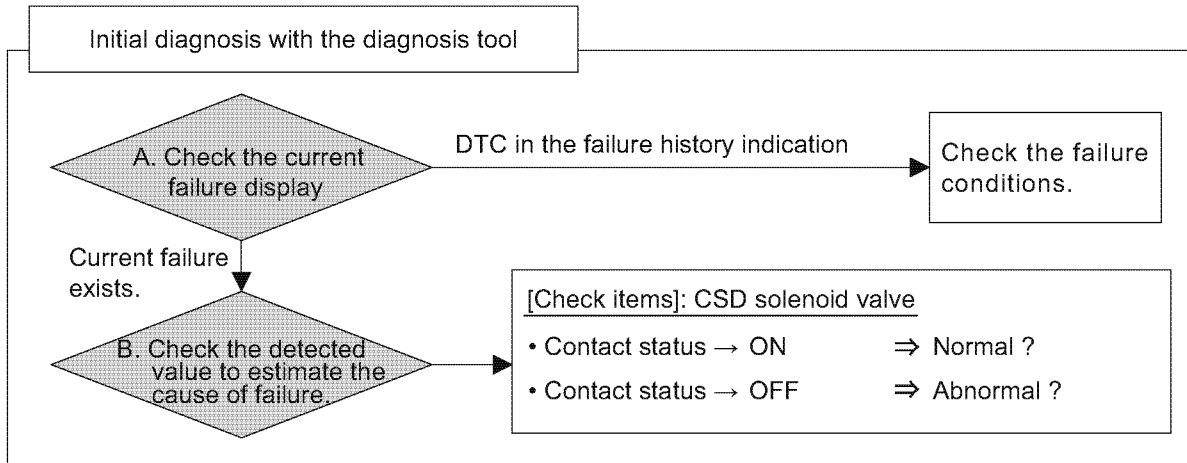

Wiring Diagram

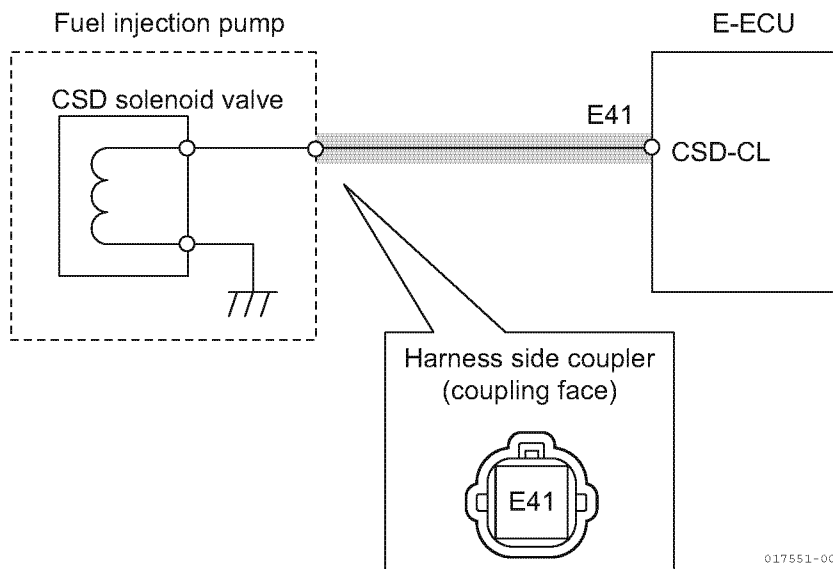
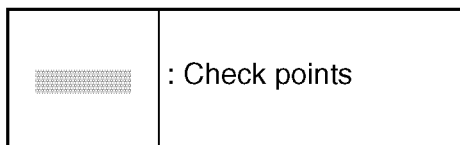

017551-00E

*For the E-ECU Pin Layout, see [E-ECU Pin Layout Diagram] (P.1-134).

Work Description

1. Check of resistance value of the CSD solenoid valve coil (solenoid valve only):

- Remove the CSD solenoid valve connector from the harness.
- Measure the resistance between CSD solenoid valve side terminals C and D using a circuit tester.

(REF) Coil resistance of the CSD solenoid valve

Terminal	Specification
CSD solenoid valve side C - D (400W)	8Ω (at 23°C)

NG	Replace the solenoid valve.
OK	Check the coil resistance of the CSD solenoid valve with the CSD solenoid valve connector and the harness being connected. → Go to [2. Check of resistance value of the CSD solenoid valve coil (solenoid valve + harness):]

2. Check of resistance value of the CSD solenoid valve coil (solenoid valve + harness):

- Connect the CSD solenoid valve and the harness.
- Remove E-ECU from the harness.
- Measure the resistance between E-ECU connectors E41 and B00 using a circuit tester.
*See above-mentioned “(REF) Coil resistance of Yanmar standard CSD solenoid valve”.

NG	Check the harness for correct continuity. → Go to [3. Check of harness continuity:]
OK	Check the movement of the CSD solenoid valve by a diagnosis tool. → Go to [4. Movement check of the CSD solenoid valve:]

3. Check of harness continuity:

- Remove the CSD solenoid valve connector from the harness, and remove E-ECU from the harness.
- Check the harness continuity using a circuit tester.

Terminal	Continuity	Status
CSD Solenoid Valve (upstream side) E41 [Between E-ECU and sensor connector]	Available	OK: normal
	Unavailable	NG: harness disconnection
Between E41 and GND/E28/E45/E47	Unavailable	OK: normal
	Available	NG: harness short-circuited with GND
Between E41 and E43/E48	Unavailable	OK: normal
	Available	NG: Harness short-circuited with power supply

NG	<ul style="list-style-type: none"> • Check if the harness is damaged, or if the wiring is correct. • Replace the harness.
OK	Check the movement of the CSD solenoid valve by a diagnosis tool. → Go to [4. Movement check of the CSD solenoid valve:]

4. Movement check of the CSD solenoid valve:

- Connect the 2G eco-checker harness between E-ECU and machine's harness (for details, see [How to use the 2G eco-checker harness] (P.1-135). And connect the all connectors (CSD solenoid valve connector, E-ECU).
- Connect the diagnosis tool, and log in to the diagnosis tool after key switch turning-on.
- Activate the start assistant relay by the diagnosis tool "Diagnosis Test: Active control", and measure the voltage between terminals E41 and E45.

ON/OFF setting status	Voltage	Status
ON	2.5[V] and above	OK: normal
	Under 2.5[V]	NG: Harness short-circuited with GND or E-ECU fault
OFF	1.75[V] and below	OK: normal
	Over 1.75[V]	NG: Harness short-circuited with power supply or E-ECU fault

NG	<ul style="list-style-type: none"> • Check if the harness is damaged, or if the wiring is correct. • Replace the harness.
OK	Replace the E-ECU.

EGR valve

Related DTC

DTC	P1402/4	Failure A with EGR valve (Step Motor A-Phase)
	P1403/3	Failure B with EGR valve (Step Motor A-Phase)
	P1412/4	Failure A with EGR valve (Step Motor B-Phase)
	P1413/3	Failure B with EGR valve (Step Motor B-Phase)
	P1422/4	Failure A with EGR valve (Step Motor C-Phase)
	P1423/3	Failure B with EGR valve (Step Motor C-Phase)
	P1432/4	Failure A with EGR valve (Step Motor D-Phase)
	P1433/3	Failure B with EGR valve (Step Motor D-Phase)

Work flow

*For details of the work, see after-mentioned "<Work Description>."For the operation of the diagnosis tool, see "Diagnosis tool Operation Manual" separately.

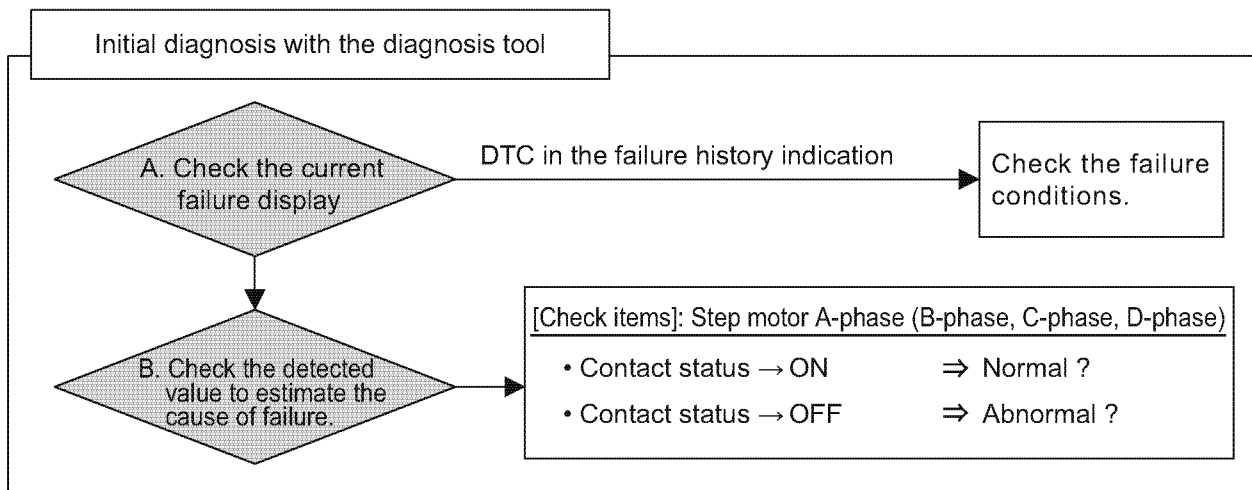

017552-00E

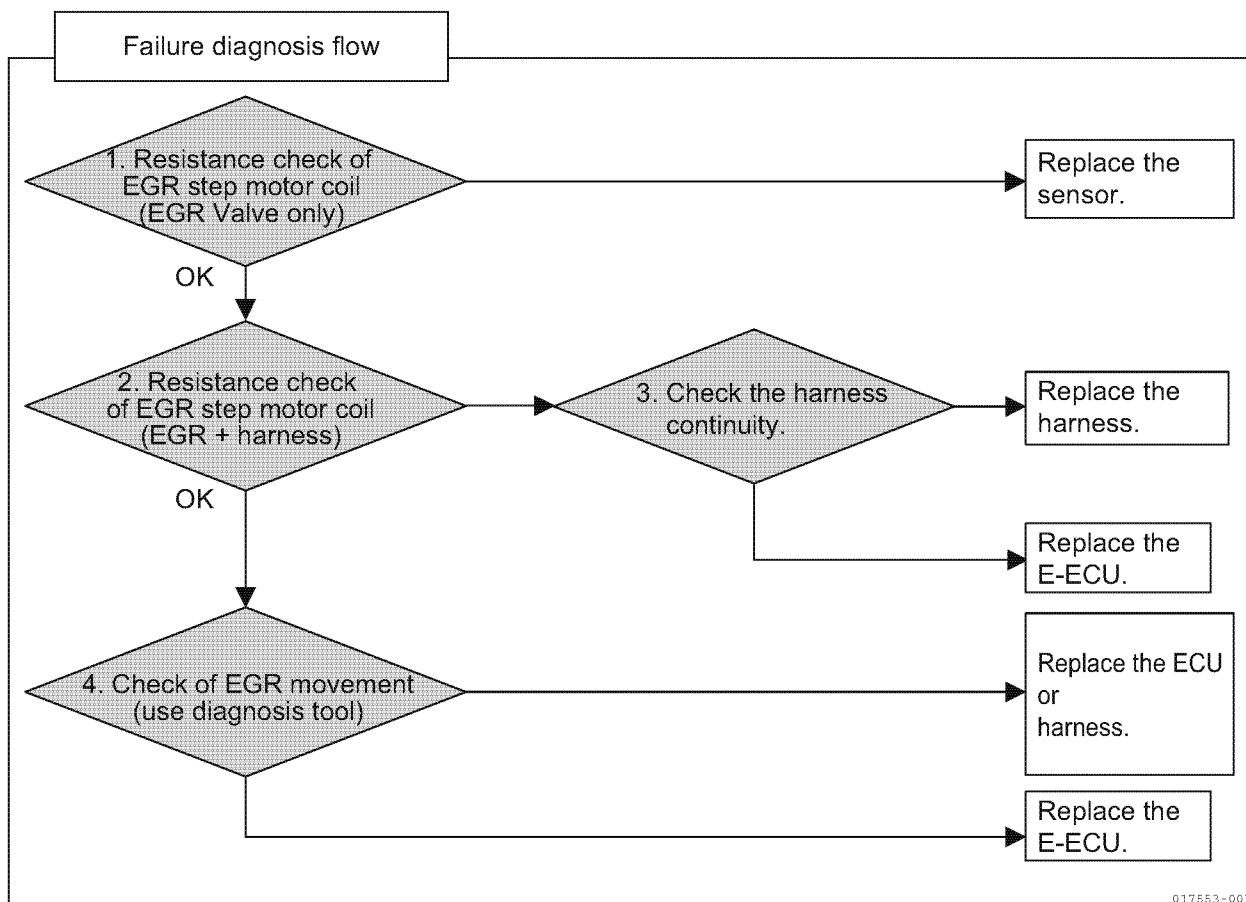

Wiring Diagram

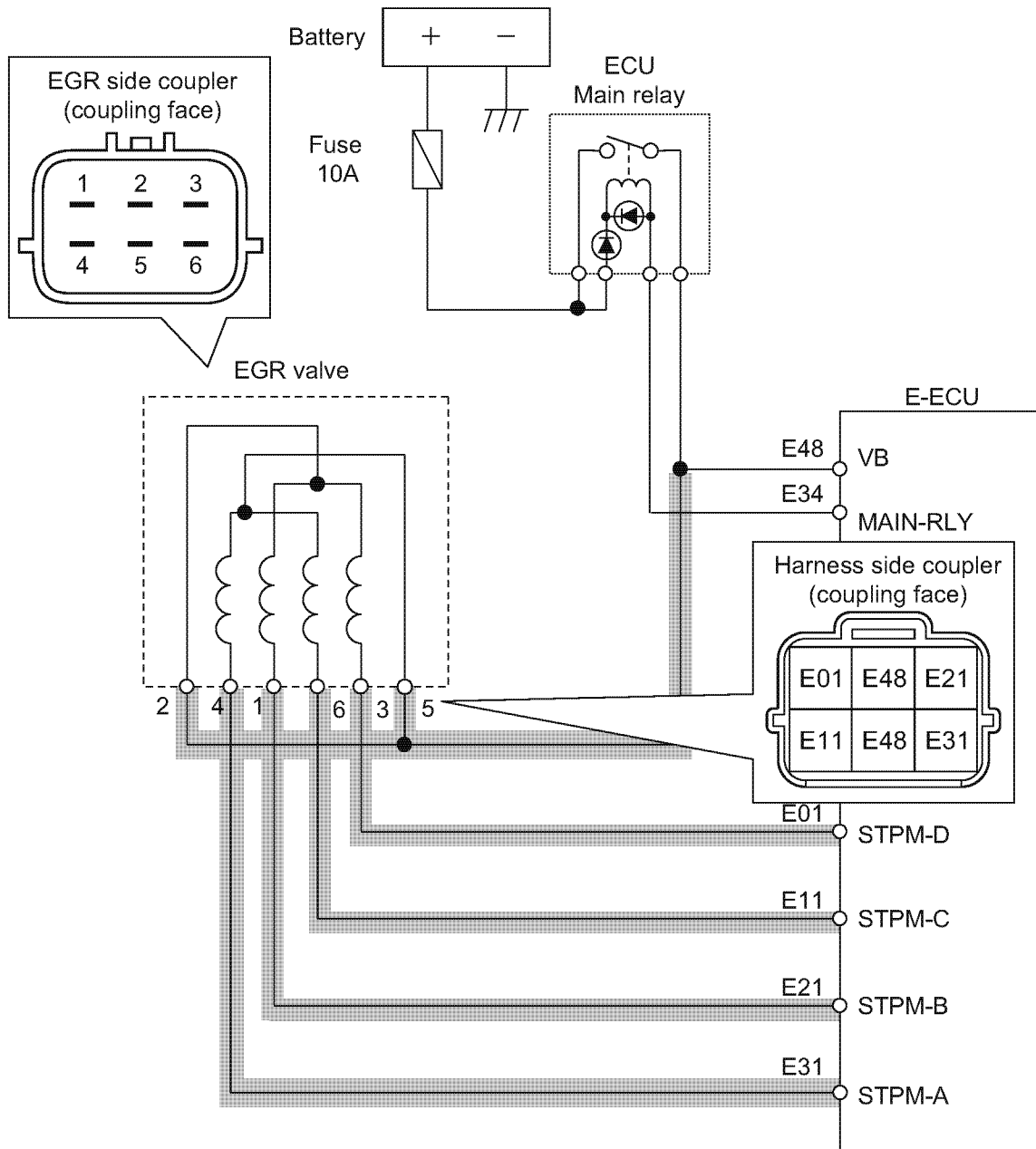
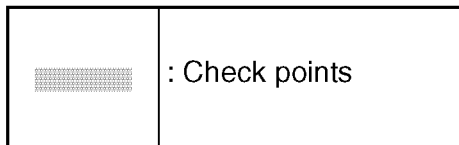

017554-00E

*For the E-ECU Pin Layout, see [E-ECU Pin Layout Diagram] (P.1-134).

Work Description

1. Check of the EGR step motor coil resistance (EGR only):

- Remove the EGR valve from the harness.
- Measure the resistance between EGR side coil terminals 4-5, (1-2, 5-6, 2-3) using a circuit tester.

(REF) Resistance value of Yanmar standard EGR step motor coil

Terminal	Specification
Coil terminal 4 - 5 (A-Phase) Coil terminal 1 - 2 (B-Phase) Coil terminal 5 - 6 (C-Phase) Coil terminal 2 - 3 (D-Phase)	15 ± 2Ω

NG	Replace the EGR valve.
OK	Check the EGR step motor coil resistance with the EGR valve and the harness being connected. → Go to [2. Check of EGR step motor coil resistance (relay + harness side):]

2. Check of EGR step motor coil resistance (relay + harness side):

- Install the EGR valve to the harness.
- Remove E-ECU from the harness.
- Measure the coil resistance at the E-ECU connector using a circuit tester.
*See above-mentioned “(REF) Resistance of Yanmar standard EGR step motor coil”.

Step motor	ECU connector terminal number
A-Phase	E31-E48
B-Phase	E21-E48
C-Phase	E11-E48
D-Phase	E01-E48

NG	Check the harness for correct continuity. → Go to [3. Check of harness continuity:]
OK	Check the movement of the EGR by the diagnosis tool. → Go to [4. Movement check of the EGR:]

3. Check of harness continuity:

- Remove the EGR valve from the harness, and remove E-ECU from the harness.
- Check the harness continuity using a circuit tester.

Terminal	Continuity	Status
Motor coil (downstream side) E31 (E21/E11/E01) [Between E-ECU and EGR connector]	Available	OK: normal
	Unavailable	NG: harness disconnection
Motor coil (upstream side) E48 [Between E-ECU and EGR connector]	Available	OK: normal
	Unavailable	NG: harness disconnection
Between E31 (E21/E11/E01) and GND/E28/E45/E47	Unavailable	OK: normal
	Available	NG: harness short-circuited with GND
Between E31 (E21/E11/E01) and E43/E48	Unavailable	OK: normal
	Available	NG: Harness short-circuited with power supply

NG	<ul style="list-style-type: none"> • Check if the harness is damaged, or if the wiring is correct. • Replace the harness.
OK	Check the movement of the EGR by the diagnosis tool. → Go to [4. Movement check of the EGR:]

4. Movement check of the EGR:

- Connect the 2G eco-checker harness between E-ECU and machine's harness (for details, see [How to use the 2G eco-checker harness] (P.1-135). And connect the all connectors (EGR valve, E-ECU).
- Connect the diagnosis tool, and log in to the diagnosis tool after key switch turning-on.
- Activate each step motor of the EGR valve by the diagnosis tool "Diagnosis Test: Active control", and measure the voltage between step motor coil terminals E31-E45, (E21-E45, E11-E45, E01-E45) respectively.

ON/OFF setting status	Voltage	Status
ON	1.75[V] and below	OK: normal
	Over 1.75[V]	NG: Harness short-circuited with power supply or E-ECU fault
OFF	2.5[V] and above	OK: normal
	Under 2.5[V]	NG: Harness short-circuited with GND or E-ECU fault

NG	<ul style="list-style-type: none"> • Check if the harness is damaged, or if the wiring is correct. • Replace the harness.
OK	Replace the E-ECU.

Contact Input Related Failures

Related DTC

DTC	P1192/4	Failure with oil pressure switch
	P1198/1	Abnormal Oil Pressure Descend
	P1562/4	Failure with Charge Switch
	P1568/1	Charge Alarm
	P1217/0	Abnormal Water Temperature
	P1101/0	Air cleaner Clogging Alarm
	P1151/0	Oil-water separator Alarm

Work flow

*For details of the work, see after-mentioned "<Work Description>." For the operation of the diagnosis tool, see "Diagnosis tool Operation Manual" separately.

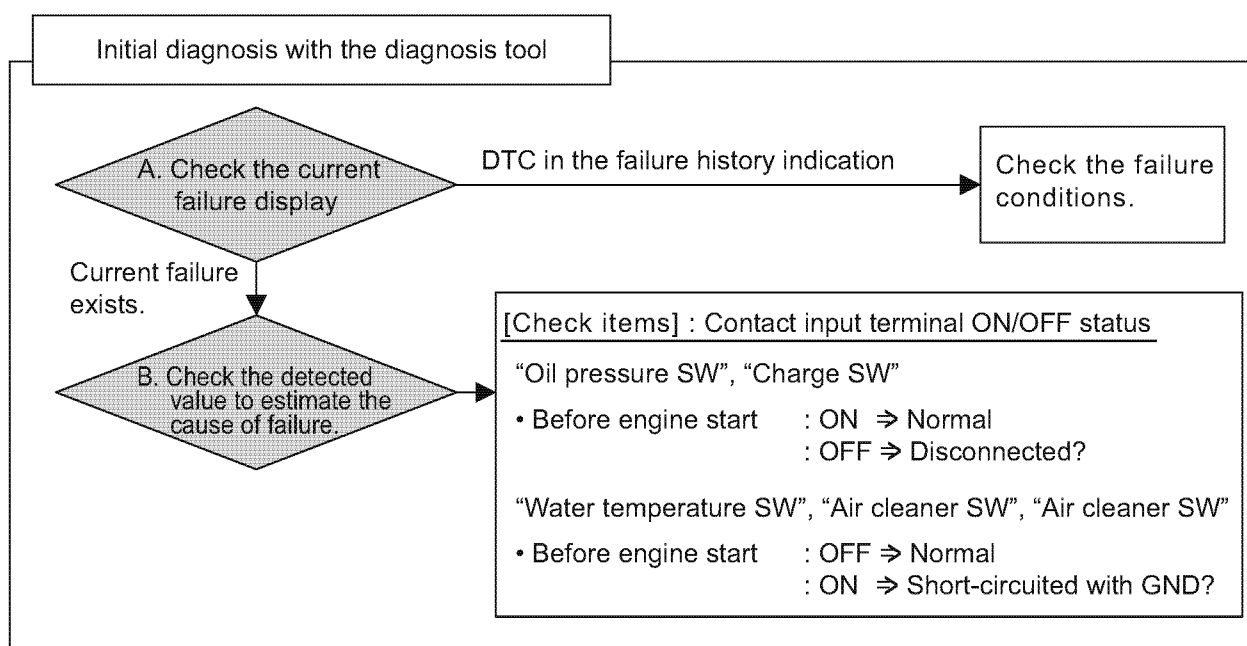

019611-00E

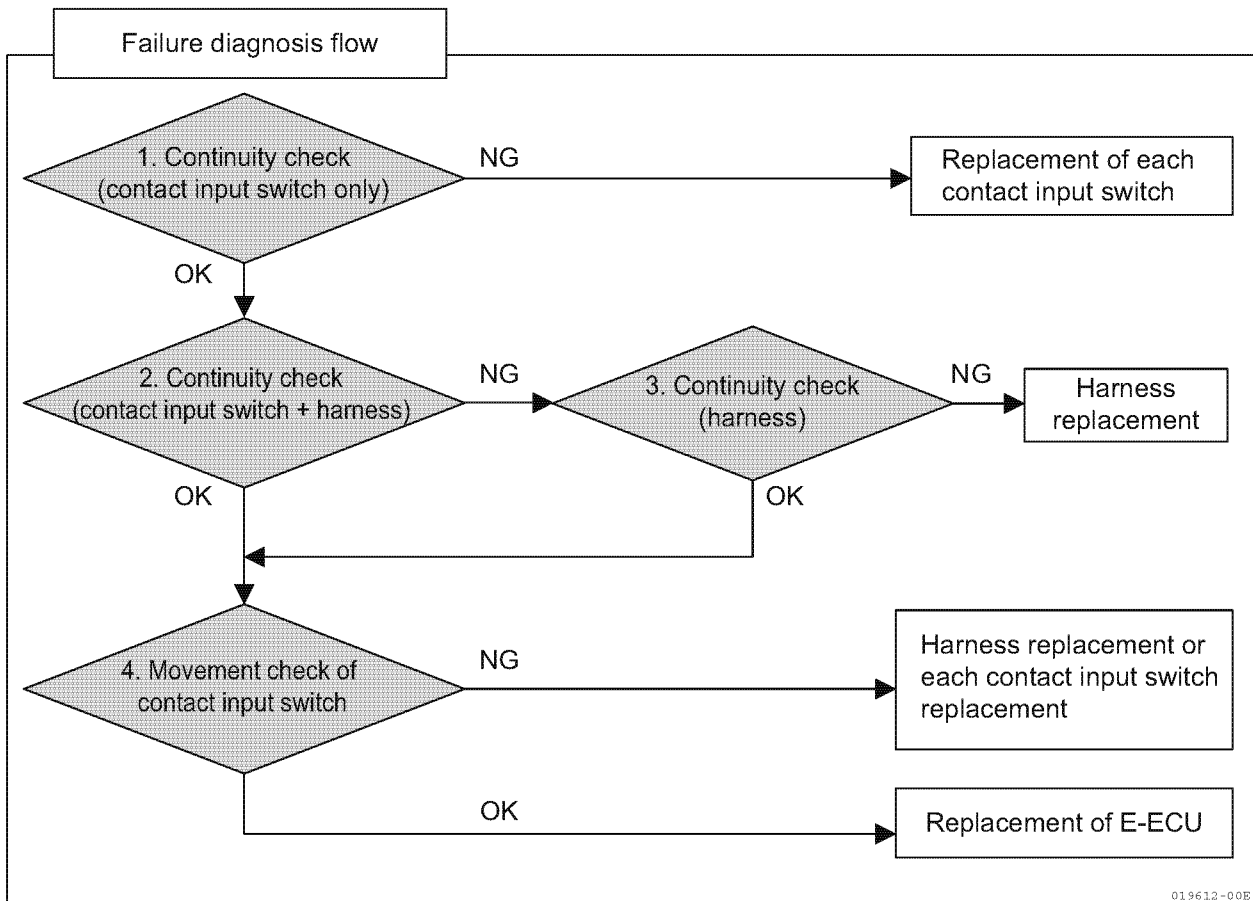

Wiring Diagram

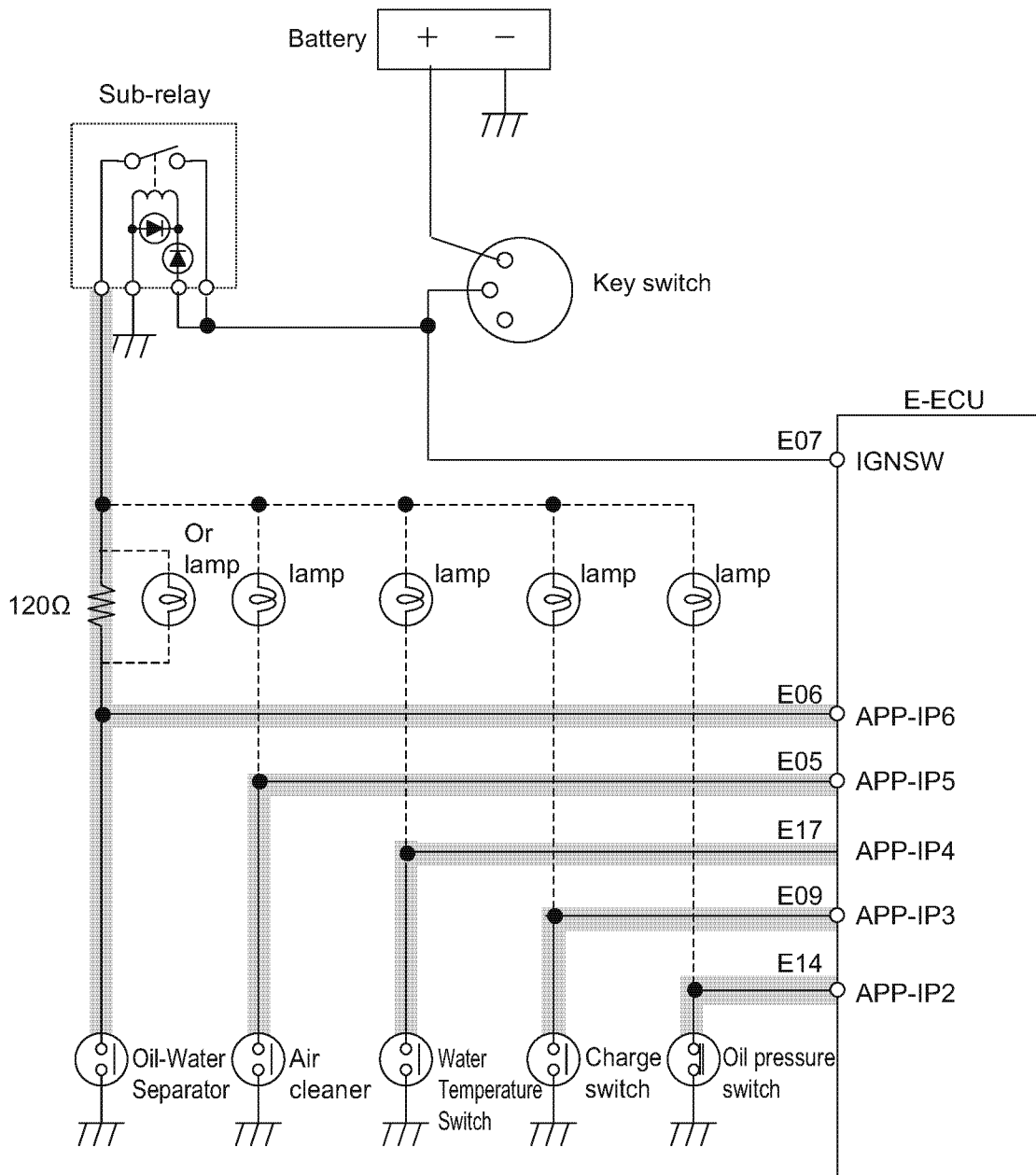
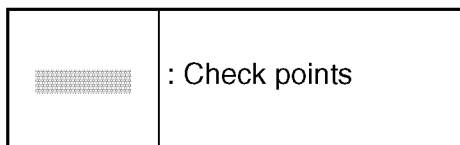

019613-00E

*For the E-ECU Pin Layout, see [E-ECU Pin Layout Diagram] (P.1-134).

Work Description

1. Continuity check (contact input switch only):

- Remove the harness from each contact input switch.
- Referring to the following table, check the continuity between contact input terminal and body frame using a circuit tester.

Item	Terminal name (Terminal No.)	Continuity [Between terminal and body frame]	Status
Oil pressure switch	APP-IP2 (E14)	Available	OK: normal
		Unavailable	NG: Internal circuitry fault
Charge Switch	APP-IP3 (E09)	Unavailable	OK: normal
		Available	NG: Internal circuitry fault
Water Temperature Switch	APP-IP4 (E17)	Unavailable	OK: normal
		Available	NG: Internal circuitry fault
Air cleaner switch	APP-IP5 (E05)	Unavailable	OK: normal
		Available	NG: Internal circuitry fault
Oil-Water Separator Switch	APP-IP6 (E06)	Unavailable	OK: normal
		Available	NG: Internal circuitry fault

NG	Replace the contact input switch.
OK	Check the continuity with the contact input switch and the harness being connected. → Go to [2. Continuity check (contact input switch + harness):]

2. Continuity check (contact input switch + harness):

- Connect the contact input switch and the harness, and remove E-ECU from the harness.
- Check the continuity between harness ECU connector terminal and body frame using a circuit tester. Then, for the terminal name to be checked, refer to above-mentioned [1. Continuity check (contact input switch only):].

NG	Check the harness for correct continuity. → Go to [3. Check of harness continuity:]
OK	Check if the movement of the contact input switch is correctly recognized with the diagnosis tool "Diagnosis Test". → Go to [4. Movement check of the contact input switch:]

3. Check of harness continuity:

- Remove the contact input switch and E-ECU from the harness.
- Check the harness continuity using a circuit tester.

Terminal	Continuity	Status
Switch signal wire E14 (*) [Between E-ECU and switch connector]	Available	OK: normal
	Unavailable	NG: harness disconnection
Between E14 (*) and E38/E43/E48 (power supply line)	Unavailable	OK: normal
	Available	NG: Harness short-circuited with power supply
Between E14 (*) and E28/E45/E47(GND line)/GND	Unavailable	OK: normal
	Available	NG: harness short-circuited with GND

*This table takes an oil pressure switch as an example. In the case of charge switch (E09), water temperature switch (E17), air cleaner switch (E05), oil-water separator switch (E06), check the continuity using the same procedure.

NG	<ul style="list-style-type: none"> • Check if the harness is damaged, or if the wiring is correct. • Replace the harness.
OK	Check if the movement of the contact input switch is correctly recognized with the diagnosis tool "Diagnosis Test". → Go to [4. Movement check of the contact input switch:]

4. Movement check of the contact input switch:

- Connect the all connectors (contact input switch, E-ECU).
- Connect the diagnosis tool, and log in to the diagnosis tool after key switch turning-on.
- With the diagnosis tool “Diagnosis Test: Digital Input etc.”, monitor each of displayed items, check the ON/OFF indication of the contact input switch under the specified conditions.

Item	Check conditions	ON/OFF indication	Status
Oil pressure switch	Before engine start	ON	OK: normal
		OFF	NG: Harness error or internal circuitry fault
	During engine running	OFF	OK: normal
		ON	NG: Harness error or internal circuitry fault
Charge Switch	Before engine start	ON	OK: normal
		OFF	NG: Harness error or internal circuitry fault
	During engine running	OFF	OK: normal
		ON	NG: Harness error or internal circuitry fault
Water Temperature Switch	Before engine start	OFF	OK: normal
		ON	NG: Harness error or internal circuitry fault
Air cleaner switch	Before engine start	OFF	OK: normal
		ON	NG: Harness error or internal circuitry fault
Oil-Water Separator Switch	Before engine start	OFF	OK: normal
		ON	NG: Harness error or internal circuitry fault

NG	<ul style="list-style-type: none"> • Check if the harness is damaged, or if the wiring is correct. • Replace the harness. • Replace the contact input switch.
OK	Replace the E-ECU.

Actuator Related Failures

Rack actuator

Related DTC

DTC	P1212/4	Failure with Rack Actuator (Low Voltage)
	P1213/3	Failure with Rack Actuator (High Voltage)
	P1211/7	Rack Actuator Mechanical Failure

Work flow

*For details of the work, see after-mentioned "<Work Description>."For the operation of the diagnosis tool, see "Diagnosis tool Operation Manual" separately.

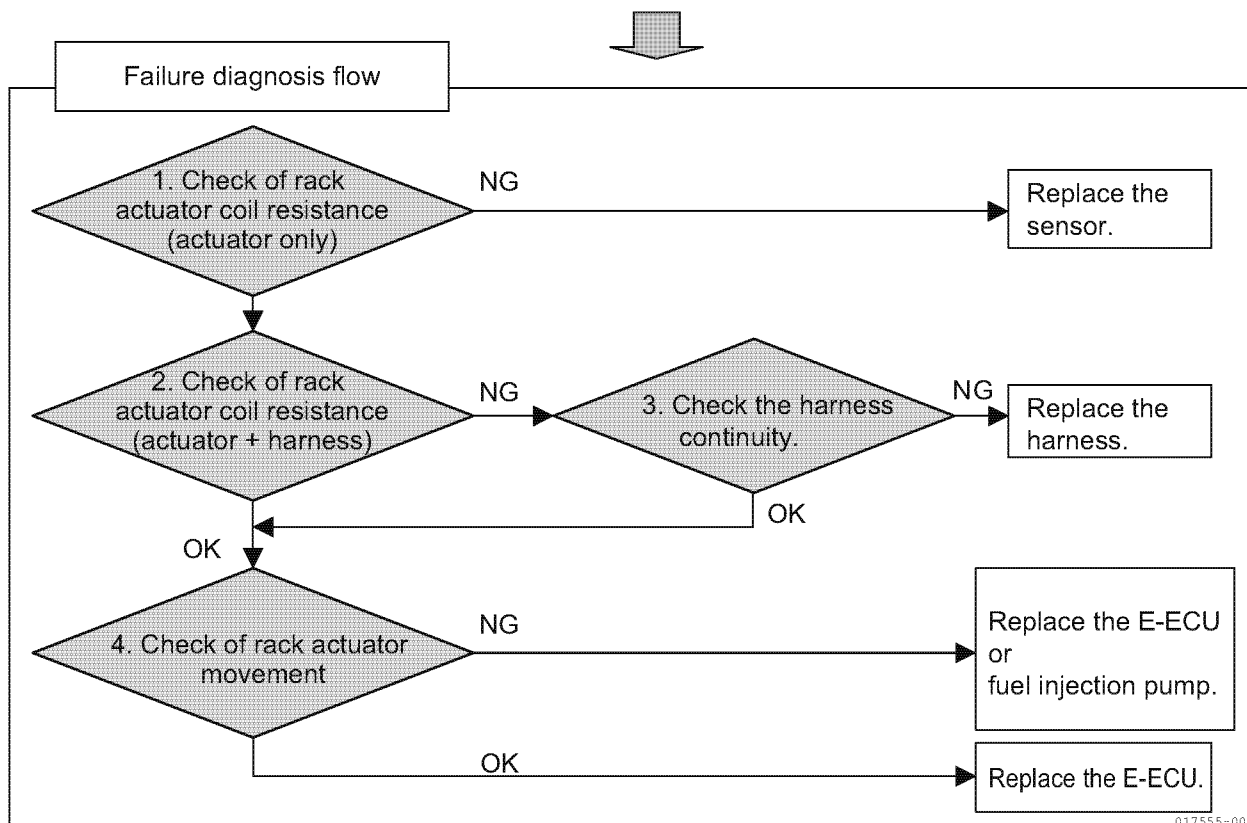
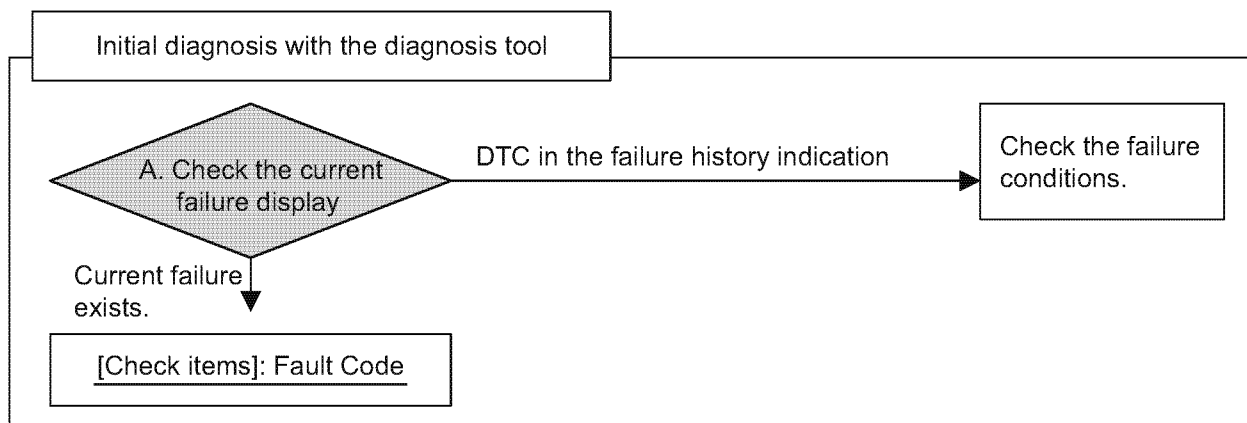

017555-00B

Wiring Diagram

 : Check points

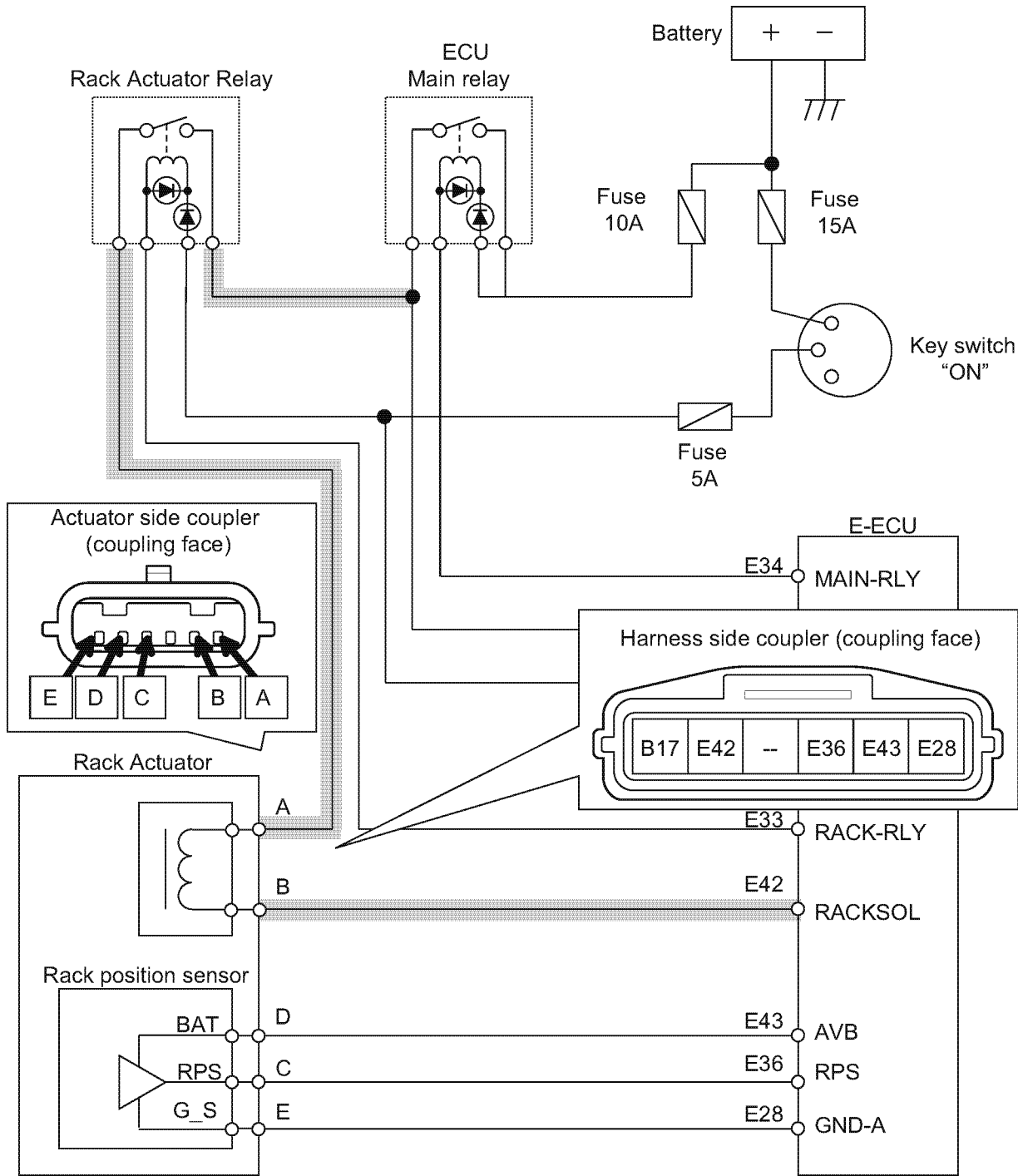

017556-00B

*For the E-ECU Pin Layout, see [E-ECU Pin Layout Diagram] (P.1-134).

Work Description

1. Check of the rack actuator coil resistance (actuator only):

- Remove the harness from the rack actuator.
- Measure the resistance between rack actuator terminals A and B using a circuit tester.

(REF) Coil resistance value of Yanmar standard rack actuator

Terminal	Specification
Coils A - B	1Ω ± 10%

NG	Replace the fuel injection pump.
OK	Check the resistance between actuator terminals A and B with the rack actuator and the harness being connected. → Go to [2. Check of the rack actuator coil resistance (harness + actuator):]

2. Check of the rack actuator coil resistance (harness + actuator):

- Connect rack actuator and harness, and remove E-ECU and rack actuator from the harness.
- Measure the resistance between harness side E-ECU connector terminal E42 and rack actuator relay contact downstream side E18 using a circuit tester.
*See above-mentioned “(REF) Coil resistance of Yanmar standard speed sensors”.

NG	Check the harness for correct continuity. → Go to [3. Check of harness continuity:]
OK	Check the movement of the actuator by the diagnosis tool. → Go to [4. Movement check of the rack actuator:]

3. Check of harness continuity:

- Remove the rack actuator and E-ECU from the harness.
- Check the harness continuity using a circuit tester.

Terminal	Continuity	Status
Actuator coil wire (downstream side) E42 [Between E-ECU and sensor connector]	Available	OK: normal
	Unavailable	NG: harness disconnection
Between actuator coil (upstream) and rack actuator relay contact (downstream)	Available	OK: normal
	Unavailable	NG: harness disconnection
Between rack actuator relay contact (downstream) and main relay contact (downstream)	Available	OK: normal
	Unavailable	NG: harness disconnection

NG	<ul style="list-style-type: none"> • Check if the harness is damaged, or if the wiring is correct. • Replace the harness.
OK	Replace the E-ECU.

4. Movement check of the rack actuator:

- Connect the all connectors (rack actuator, E-ECU).
- Connect the diagnosis tool, and log in to the diagnosis tool after key switch turning-on.
- Execute the directive rack position control with the diagnosis tool "Diagnosis Test: Active control". At this time, set the rack position arbitrarily within the settings.
- After the execution, check if the rack actuator moved to the set rack position.

NG	Replace the fuel injection pump.
OK	Replace the E-ECU.

ECU Internal and Communication Errors

ECU Internal Errors

Related DTC

DTC	P0601/12	EEPROM error (read/write error)
	P1601/2	EEPROM error (Checksum)
	P0605/12	Flash ROM error (Checksum A)
	P1605/2	Flash ROM error (Checksum B)
	P1606/2	Flash ROM error (Checksum C)
	P1610/12	Failure A with Sub-CPU
	P1611/12	Failure B with Sub-CPU
	P1612/12	Failure C with Sub-CPU
	P1620/12	Map format error

Work flow

*For details of the work, see after-mentioned "<Work Description>." For the operation of the diagnosis tool, see "Diagnosis tool Operation Manual" separately.

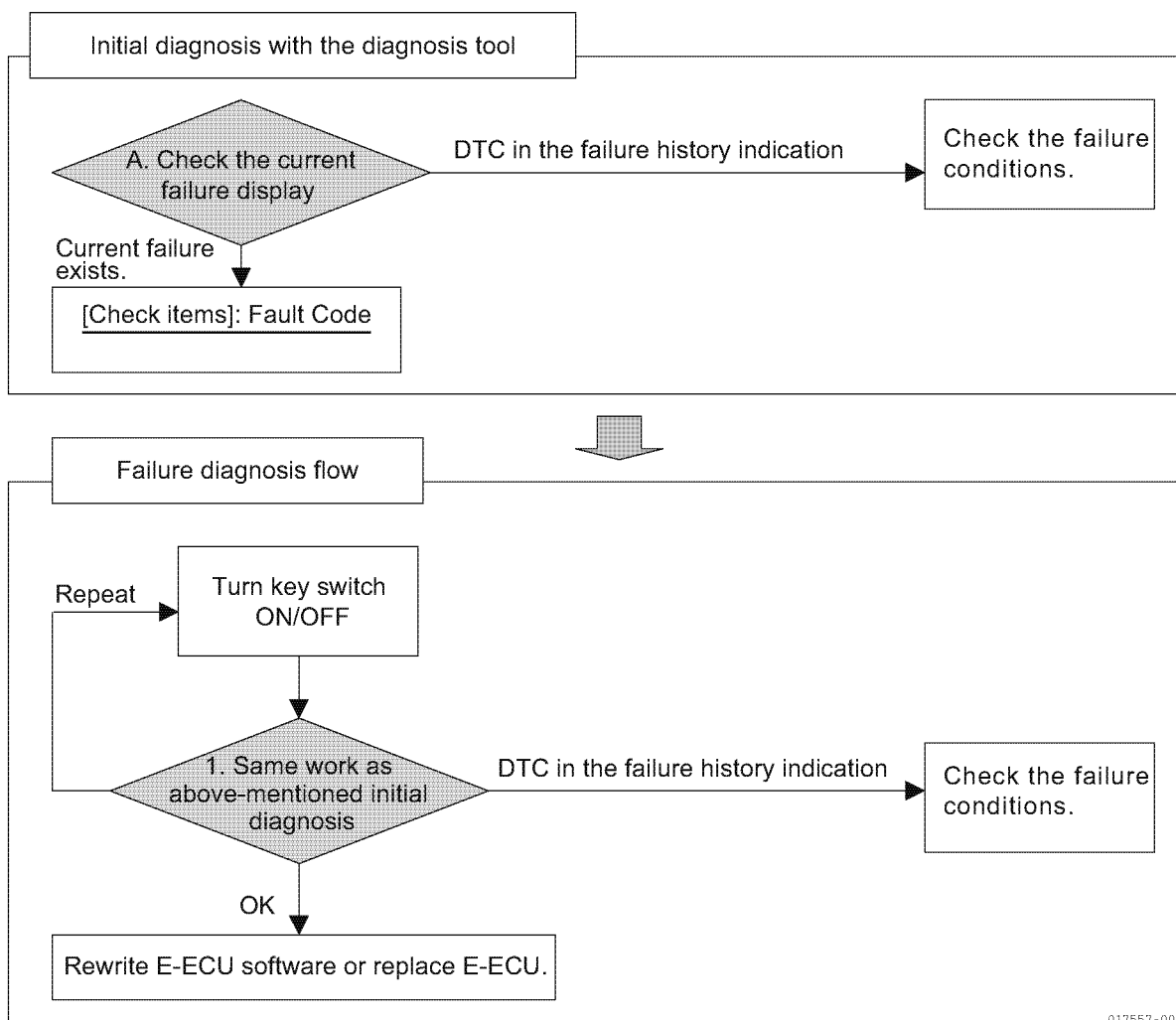

Work Description

1. Work with the diagnosis tool:

- Turn the key switch off, and turn the key switch on again.
- Connect the diagnosis tool, and check if any error is detected on the current fault indication.

Unavailable	Check the error history indication, confirm error occurrence situation if any error history is indicated.
Available	<ul style="list-style-type: none"> • Turn the key switch on/off again, and perform the work [1. Work with the diagnosis tool:]. • Rewrite the E-ECU software. • Replace the E-ECU.

Main relay

Related DTC

DTC	P0686/4	Main relay error
-----	---------	------------------

Work flow

*For details of the work, see after-mentioned "<Work Description>." For the operation of the diagnosis tool, see "Diagnosis tool Operation Manual" separately.

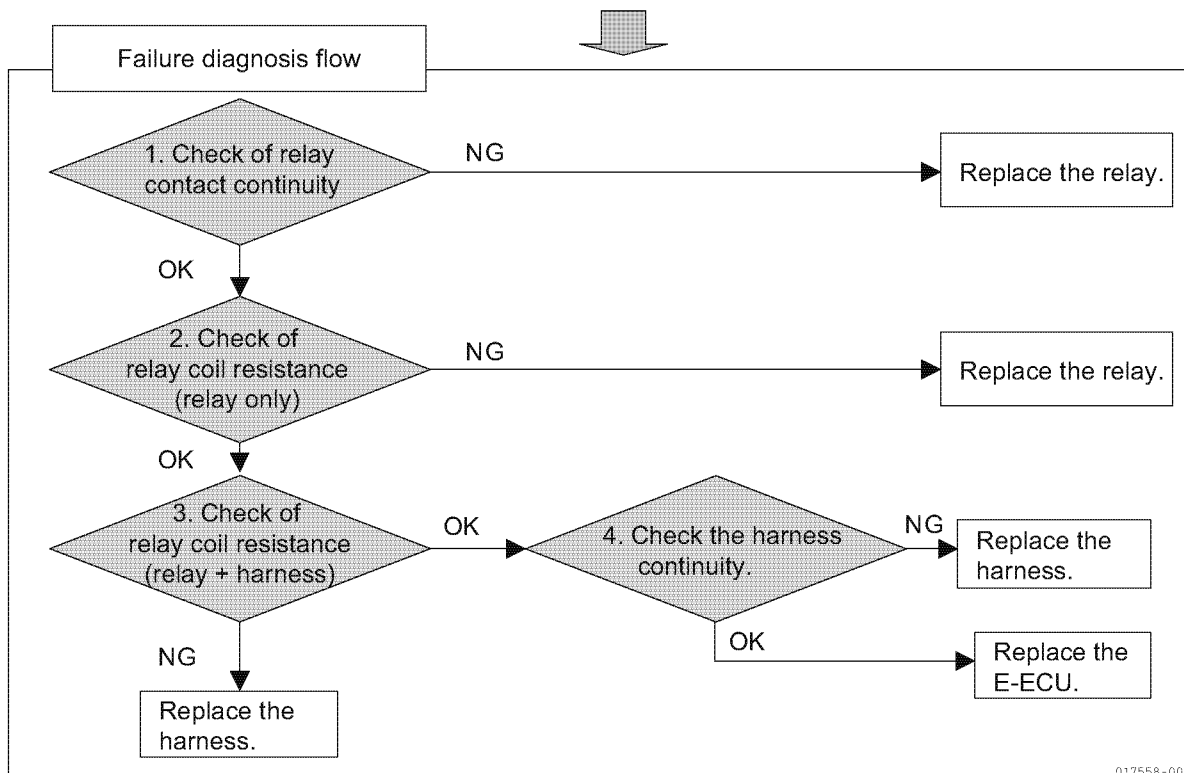
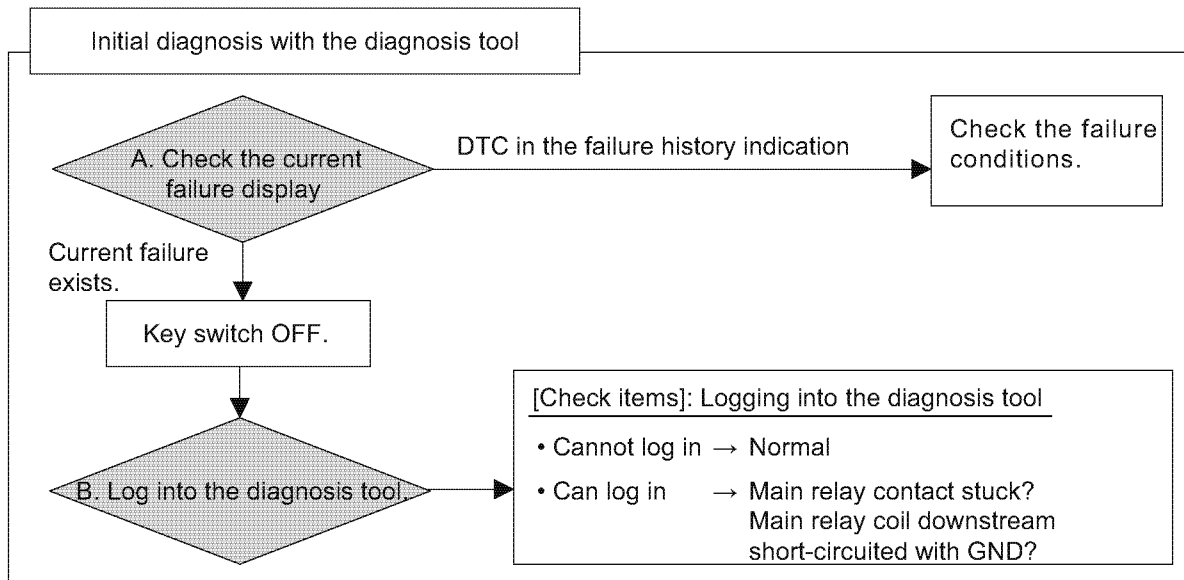

017558-00B

Wiring Diagram

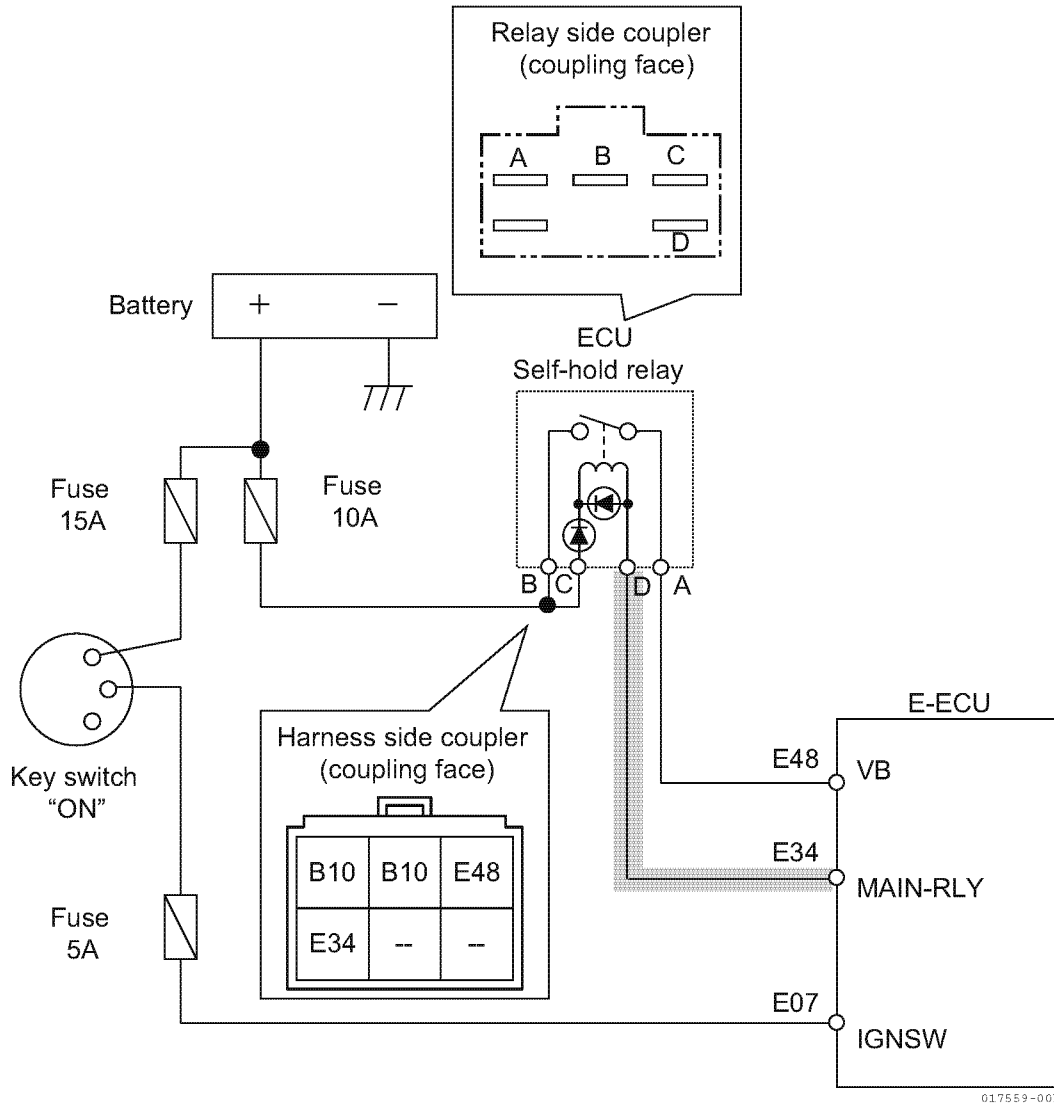
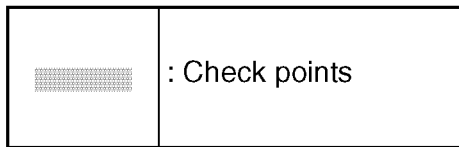

*For the E-ECU Pin Layout, see [E-ECU Pin Layout Diagram] (P.1-134).

Work Description

1. Check of the relay coil resistance value (relay only):
 - Remove the E-ECU main relay from the harness.
 - Check the continuity between relay side terminals A and B using a circuit tester.

NG	Replace the E-ECU main relay.
OK	Check the resistance of the E-ECU main relay coil. → Go to [2. Check of the relay coil resistance value (relay only):]

2. Check of the relay coil resistance value (relay only):
 - Remove the E-ECU main relay from the harness.
 - Measure the resistance between relay side terminals C and D using a circuit tester.

Measurement conditions		Measured value	Status
Tester (+) side	Tester (-) side		
Terminal C	Terminal D	Available (*)	OK when both are normal
Terminal D	Terminal C	Infinity (*)	
Terminal C	Terminal D	Infinity (*)	NG: Fault of the relay internal circuitry
Terminal D	Terminal C		

*As a reverse-biased diode is integrated, the above-mentioned checking method is applied, and the measured value varies depending on a circuit tester to be used.

NG	Replace the E-ECU main relay.
OK	Check the relay coil resistance with the E-ECU main relay and the harness being connected. → Go to [3. Check of relay coil resistance value (relay + harness side):]

3. Check of relay coil resistance value (relay + harness side):
 - Install the E-ECU main relay to the harness.
 - Remove E-ECU from the harness.
 - Measure the resistance between battery cable (+) line and harness side E-ECU connector E34.

Measurement conditions		Measured value	Status
Tester (+) side	Tester (-) side		
Battery (+) line	E34	Available (*)	OK: normal
E34	Battery (+) line	Infinity (*)	
Battery (+) line	E34	Infinity (*)	NG: Harness error
E34	Battery (+) line		

*As a reverse-biased diode is integrated, the above-mentioned checking method is applied, and the measured value varies depending on a circuit tester to be used.

NG	Replace the harness.
OK	Check the harness for correct continuity. → Go to [4. Check of harness continuity:]

4. Check of harness continuity:

- Remove the E-ECU main relay from the harness and remove the E-ECU from the harness.
- Check the harness continuity using a circuit tester.

Terminal	Continuity	Status
Between relay coil (downstream side) E34 and GND/E28/E45/E47	Unavailable	OK: normal
	Available	NG: harness short-circuited with GND
Between relay contact (downstream side) E48 and E43/battery(+)	Unavailable	OK: normal
	Available	NG: Harness short-circuited with power supply

NG	<ul style="list-style-type: none"> • Check if the harness is damaged, or if the wiring is correct. • Replace the harness.
OK	<ul style="list-style-type: none"> • Connect the all connectors (E-ECU main relay, E-ECU), and recheck that any error is detected with the diagnosis tool "Fault code: Current fault indication" again. • Replace the E-ECU.

CAN Communication

Related DTC

DTC	U0001/12	CAN Communication Error
-----	----------	-------------------------

Work flow

*For details of the work, see after-mentioned "<Work Description>." For the operation of the diagnosis tool, see "Diagnosis tool Operation Manual" separately.

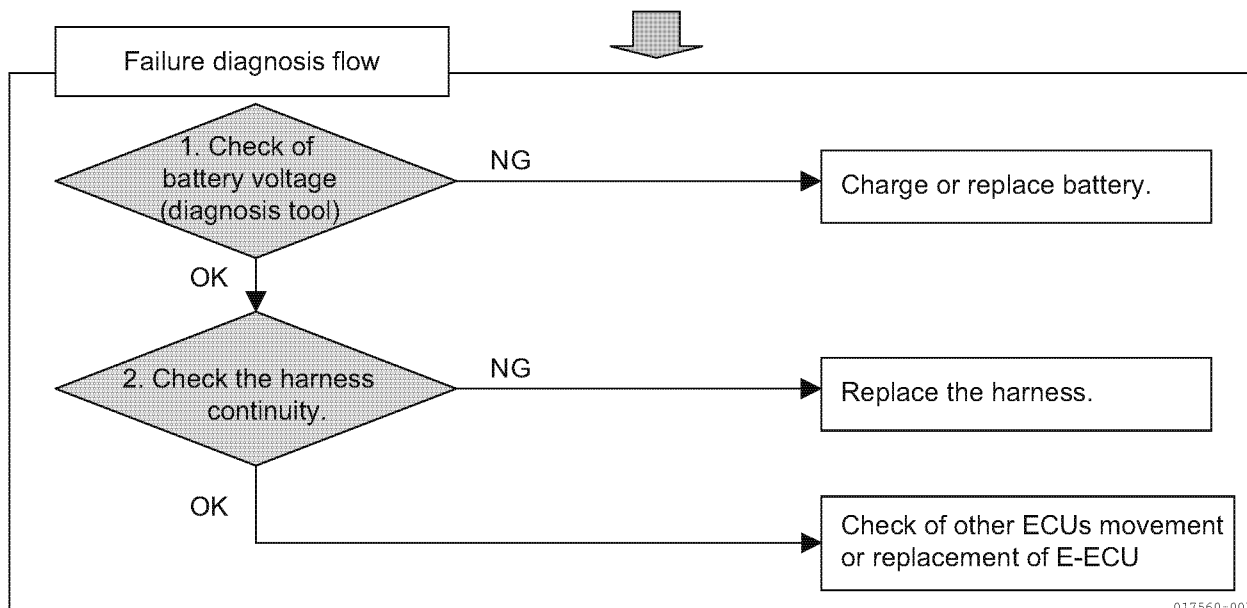
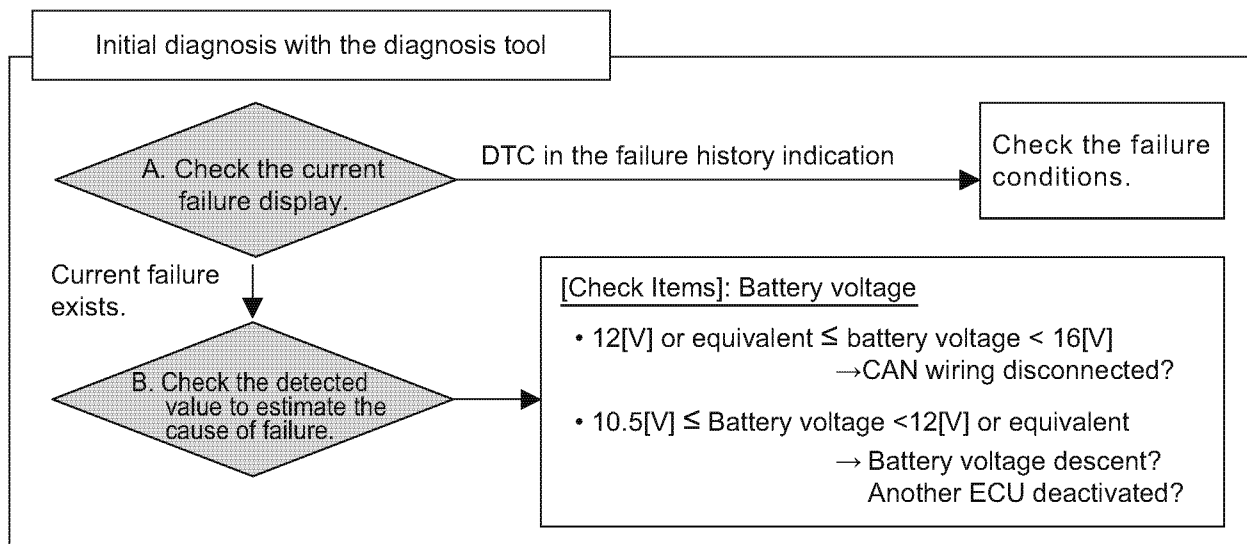

017560-00B

Work Description

1. Battery voltage check:

- During the engine running, connect the diagnosis tool and log in to the diagnosis tool.
- Check the battery voltage with the diagnosis tool “Diagnosis Test: Pulse/analog etc.”.

Voltage	Status	Action
Approx.12[V] ≤ battery voltage < 16[V]	OK (normal range)	Check the harness for correct continuity.
10.5[V] ≤ battery voltage < approx.12[V]	NG	<ul style="list-style-type: none"> • Charge or replace the battery. • Check the movement of other E-ECUs.

NG	<ul style="list-style-type: none"> • Charge or replace the battery. • Check the movement of other E-ECUs.
OK	Check the harness for correct continuity. → Go to [2. Check of harness continuity:]

2. Check of harness continuity:

- Check the harness continuity using a circuit tester.

Terminal	Continuity	Status
CAN wiring (Hi side) E40 (Between E-ECU and sensor connector)	Available	OK: normal
	Unavailable	NG: harness disconnection
CAN wiring (Low side) E39 (Between E-ECU and sensor connector)	Available	OK: normal
	Unavailable	NG: harness disconnection
Between E39/E40 and GND/E28/E45/E47	Unavailable	OK: normal
	Available	NG: harness short-circuited with GND

NG	<ul style="list-style-type: none"> • Check if the harness is damaged, or if the wiring is correct. • Replace the harness.
OK	<ul style="list-style-type: none"> • Check the movement of other E-ECUs. • Replace the E-ECU.

Immobilizer

Related DTC

DTC	U1167/8	Immobilizer Error (pulse communication)
-----	---------	---

Work flow

*For details of the work, see after-mentioned "<Work Description>." For the operation of the diagnosis tool, see "Diagnosis tool Operation Manual" separately.

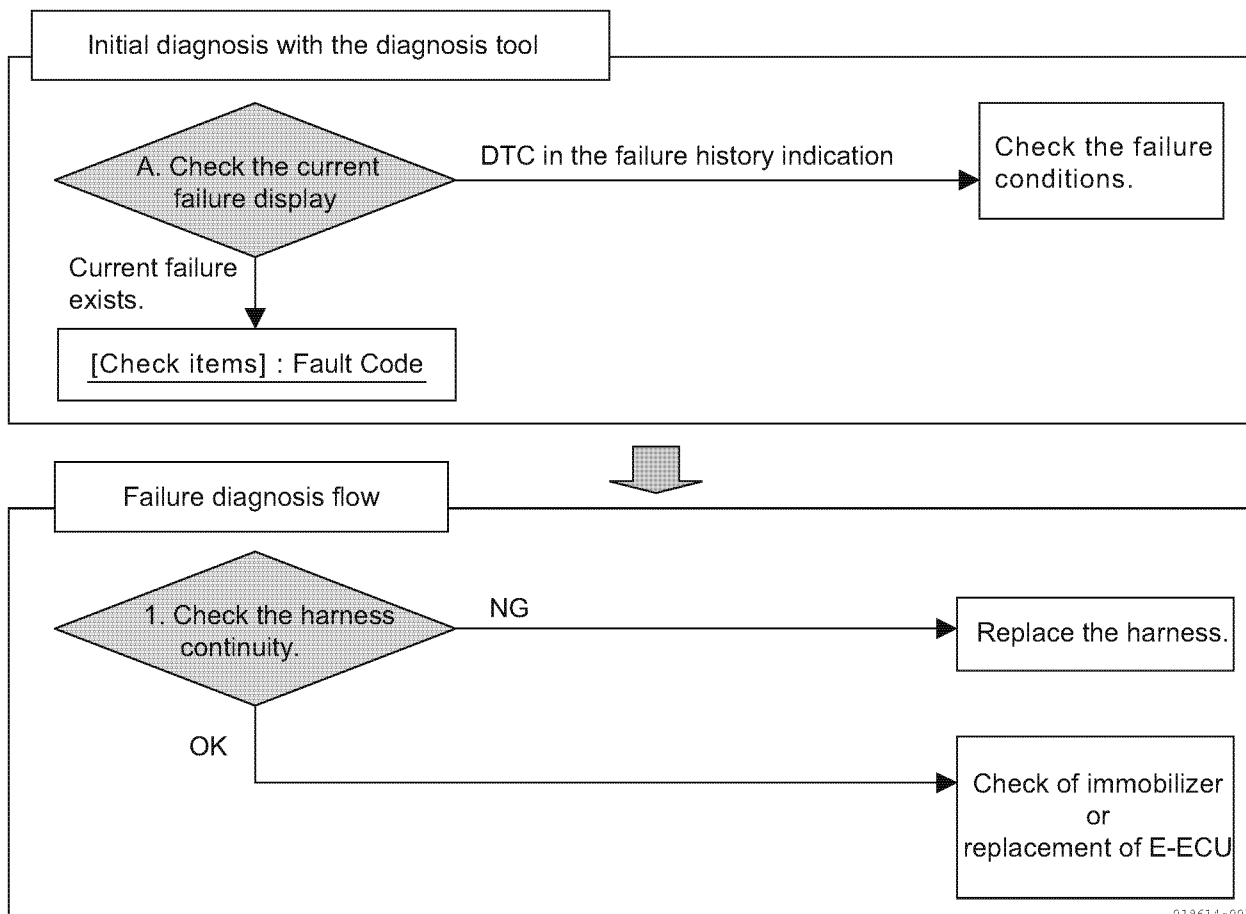

Wiring Diagram

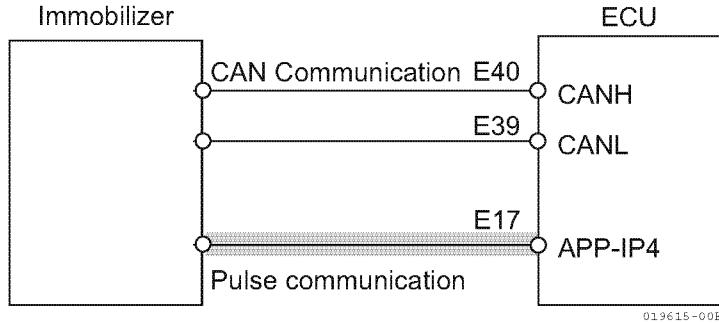
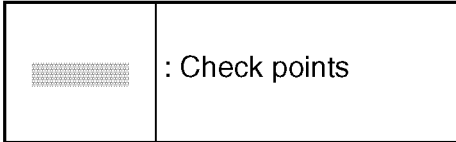

* For the E-ECU Pin Layout, see [E-ECU Pin Layout Diagram] (P.1-134).

Work Description

1. Harness continuity check:
 - Remove the immobilizer and E-ECU from the harness.
 - Check the harness continuity using a circuit tester.

Terminal	Continuity	Status
Immobilizer pulse communication line E17 [Between E-ECU and immobilizer]	Available	OK: normal
	Unavailable	NG: harness disconnection
Between E17 and E38/E43/E48(power supply line)	Unavailable	OK: normal
	Available	NG: Harness short-circuited with power supply
Between E17 and E28/E45/E47(GND line)/GND	Unavailable	OK: normal
	Available	NG: harness short-circuited with GND

NG	<ul style="list-style-type: none"> • Check if the harness is damaged, or if the wiring is correct. • Replace the harness.
OK	<ul style="list-style-type: none"> • Check the immobilizer. • Replace the E-ECU.

FAILURE INDICATOR LAMP FLASHING PATTERN

This section provides examples that demonstrate how the failure indicator flashes in a pattern specific to the DTC that occurs.

If an accelerator sensor failure is detected at power-on time, the failure indicator flashes in a pattern of 5 (five equal flashes) as shown in the first example; if an EGR valve failure is detected at power-on time, it flashes in a pattern of 13 (i.e., one long flash followed by 3 short flashes) as shown in the second example. When two or more failures occur at the same time, the failure indicator indicates all the failures one by one in the ascending order of the number of flashes.

Also, the failure indicator is always lit for 2 [s] after power-on, whether or not any failure exists.

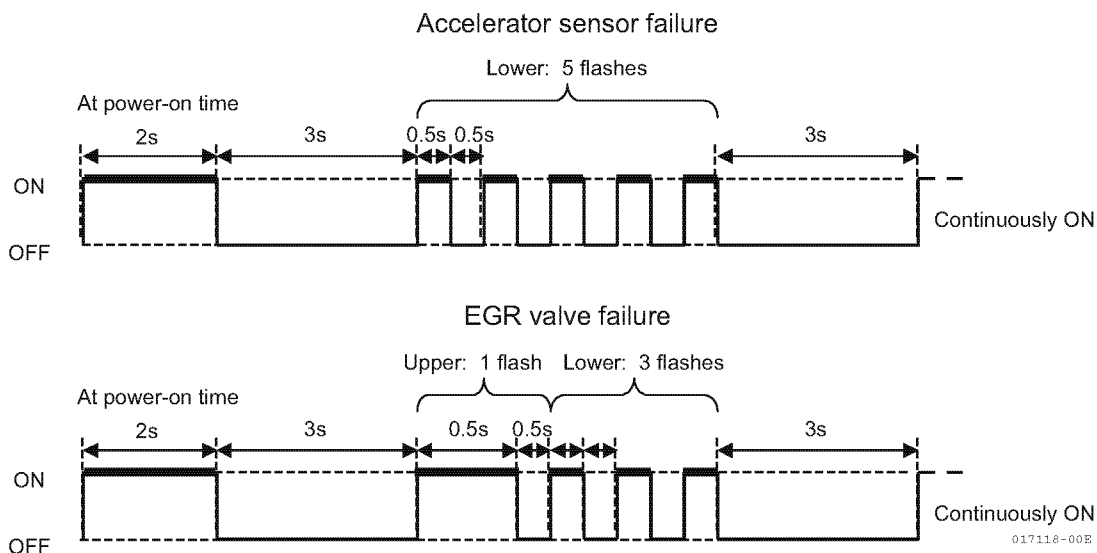

USING THE FAILURE INDICATOR FOR FAILURE DIAGNOSIS

Flashing Patterns of the Failure Indicator

Flashing Patterns of the Failure Indicator

Flashing Patterns	Error Item		DTC	Referenced page number
	Area	Status		
4	Cooling Water Temperature Sensor	Failure (low voltage)	P0117/4	P.1-45
		Failure (high voltage)	P0118/3	P.1-47
5	Accelerator Sensor	Failure (low voltage)	P0122/4	P.1-12
		Failure (high voltage)	P0123/3	P.1-14
		Intermittent failure	P0124/2	P.1-16
		Lower limit error	P1125/1	P.1-18
		Upper limit error	P1126/0	P.1-20
6	Speed Sensor	Failure (low voltage)	P0340/4	P.1-60
7	Rack Position Sensor	Failure (low voltage)	P1202/4	P.1-8
		Failure (high voltage)	P1202/3	P.1-10
8	Rack Actuator	Failure (low voltage)	P1212/4	P.1-114
		Failure (high voltage)	P1213/3	P.1-116
		Mechanical failure	P1211/7	P.1-118
9	Engine Overspeed		P0219/0	P.1-64
1-1	Spare Speed Sensor	Failure (low voltage)	P1340/4	P.1-62
1-2	CAN Communication		U0001/12	P.1-126
1-3	EGR Step Motor	A-phase failure (disconnection)	P1402/4	P.1-100
		A-phase failure (short circuit)	P1403/3	P.1-86
		B-phase failure (disconnection)	P1412/4	P.1-88
		B-phase failure (short circuit)	P1413/3	P.1-90
		C-phase failure (disconnection)	P1422/4	P.1-92
		C-phase failure (short circuit)	P1423/3	P.1-94
		D-phase failure (disconnection)	P1432/4	P.1-96
		D-phase failure (short circuit)	P1433/3	P.1-98
1-4	CSD Solenoid Valve	Failure (disconnection)	P1242/4	P.1-78
		Failure (short circuit)	P1243/3	P.1-80
		Intermittent failure	P1244/2	P.1-82
1-5	Start Assist Relay	Failure (disconnection)	P1232/4	P.1-72
		Failure (short circuit)	P1233/3	P.1-74
		Intermittent failure	P1234/2	P.1-76
1-6	Self-Hold Relay	Failure (low voltage)	P0686/4	P.1-124

Flashing Patterns	Error Item		DTC	Referenced page number	
	Area	Status			
1-7	Rack Actuator Relay	Failure (low voltage)	P1222/4	P.1-66	
		Failure (high voltage)	P1223/3	P.1-68	
		Intermittent failure	P1224/2	P.1-70	
1-8	Spare Accelerator Sensor	Failure (low voltage)	P0222/4	P.1-22	
		Failure (high voltage)	P0223/3	P.1-24	
		Intermittent failure	P0224/2	P.1-26	
		Lower limit error	P1225/1	P.1-28	
		Upper limit error	P1226/0	P.1-30	
		Communication error	P1227/8	P.1-32	
1-9	Atmospheric Pressure Sensor	Failure (low voltage)	P2228/4	P.1-34	
		Failure (high voltage)	P2229/3	P.1-36	
		Intermittent failure	P2230/2	P.1-38	
2-1	Oil Pressure Switch	Failure (disconnection)	P1192/4	P.1-100	
2-2	Charge Switch	Failure (disconnection)	P1562/4	P.1-104	
2-3	ECU Supply Voltage	Lower limit error	P0562/1	P.1-56	
		Upper limit error	P0563/0	P.1-58	
2-4	SENSOR 5V	Failure (low voltage)	P0642/4	P.1-53	
		Failure (high voltage)	P0643/3	P.1-54	
		Intermittent failure	P1644/2	P.1-55	
2-5	ECU Internal Temperature	Rise Error	P0634/0	P.1-43	
3-1	Oil Pressure	Lower limit error	P1198/1	P.1-102	
3-2	Battery Charge	Lower limit error	P1568/1	P.1-106	
3-3	Cooling Water Temperature	Error	P1217/0	P.1-108	
3-4	Air Cleaner	Mechanical failure	P1101/0	P.1-110	
3-5	Oil-Water Separator	Mechanical failure	P1151/0	P.1-112	
3-6	Cooling Water Temperature	Rise Error	P0217/0	P.1-51	
4-1	ECU Internal	Flash ROM		P0605/12	P.1-123
		EEPROM		P0601/12	P.1-122
		Sub CPU	CRC error	P1610/12	P.1-122
			Send ACK error	P1611/12	P.1-122
			Communication error	P1612/12	P.1-122
		Map format		P1620/12	P.1-123
		ECU Temperature Sensor	Failure (low voltage)	P0668/4	P.1-40
			Failure (high voltage)	P0669/3	P.1-41
			Intermittent failure	P1664/2	P.1-42

FACTOR ANALYSIS

2G-Type Eco-Governor Speed-Fluctuation Factor Analysis

No.			Check method	Relevant DTC	Remarks	
1	Engine speed fluctuation	Insufficient fuel supply	Fuel pipe clogging	Check fuel system.		
2		Engine failure	Nozzle failure etc.	Check whole engine.		
3		Working machine failure	Load fluctuation in working machine	Check whole working machine.		
4		Abnormal vibration of working machine and engine	Rack actuator hunting.	Check vibration of fuel pump.		
5		Fuel pump failure	Unstable injection due to defective rack etc.	Check fuel pump.		
6		Abnormal fluctuation of supply voltage	Battery system failure	Check error occurrence, tool data, and voltage with voltmeter.	ECU supply voltage system error: P0562/1, P0563/0	
7			Alternator system failure	Check error occurrence, tool data, and voltage with voltmeter.	Battery charging system error: P1562/4, P1568/1	
8			Fluctuation of electrical load	Check presence of failure in large-load electrical equipment such as air heater.		
9		Intermittent on/off of start-assisting heater	Wire breakage or short-circuit in harness, or connector contact failure	Check error occurrence, tool data, harness shaking, and conduction with tester.	ECU supply voltage system error: P0562/1, P0563/0	
10			Wire breakage or short-circuit in heater	Check conduction of heater.		
11			Wire breakage or short-circuit of heater relay	Check error occurrence, tool data, impact on relay, and conduction with tester.	Start-assisting relay error: P1232/4, P1233/3, P1234/2	
12			Wire breakage or short-circuit in harness, or connector contact failure	Check error occurrence, tool data, harness shaking, and conduction with tester.	Start-assisting relay error: P1232/4, P1233/3, P1234/2	

No.			Check method	Relevant DTC	Remarks
13	Intermittent on/off of CSD solenoid valve	Wire breakage or short-circuit in CSD solenoid valve	Check conduction of CSD.	CSD solenoid valve system error: P1242/4, P1243/3, P1244/2	
14		Wire breakage or short-circuit in harness, or connector contact failure	Check error occurrence, tool data, harness shaking, and conduction with tester.	CSD solenoid valve system error: P1242/4, P1243/3, P1244/2	
15	Rack actuator malfunction	Rack actuator malfunction due to excessive hysteresis etc.	Check rack actuator operation and hysteresis.	Rack actuator system error: P1212/4, P1213/3, P1211/7	
16		Wire breakage or short-circuit in harness, or connector contact failure	Check error occurrence, tool data, harness shaking, and conduction with tester.	Rack actuator system error: P1212/4, P1213/3, P1211/7	
17	Intermittent on/off of actuator relay	Contact failure of relay contact	Check error occurrence, tool data, impact on relay, and conduction with tester.	Rack actuator system error: P1212/4, P1213/3, P1211/7	
18		Wire breakage or short-circuit in relay coil	Check error occurrence, tool data, impact on relay, and conduction with tester.	Actuator relay system error: P1222/4, P1223/3, P1224/2	
19		Wire breakage or short-circuit in harness, or connector contact failure	Check error occurrence, tool data, harness shaking, and conduction with tester.	Actuator relay system error: P1222/4, P1223/3, P1224/2	
20	Rack position sensor signal failure	Wire breakage or short-circuit in sensor, or output failure	Check error occurrence, tool data, and conduction with tester.	Rack position sensor system error: P1202/4, P1203/3	
21		Wire breakage or short-circuit in harness, or connector contact failure	Check error occurrence, tool data, harness shaking, and conduction with tester.	Rack position sensor system error: P1202/4, P1203/3	
22	Speed sensor signal failure	Reversed polarity of speed sensor harness	Check polarity difference between harness drawing and actual harness.		
23		Wire breakage or short-circuit in speed sensor	Check error occurrence, tool data, and conduction with tester.	Speed sensor system error: P0340/4	
24		Wire breakage or short-circuit in harness, or connector contact failure	Check error occurrence, tool data, harness shaking, and conduction with tester.	Speed sensor system error: P0340/4	
25	Intermittent fluctuation of accelerator sensor signal	Wire breakage or short-circuit in accelerator sensor	Check error occurrence, tool data, and conduction with tester.	Accelerator sensor system error: P0222/4, P0223/3, P0224/2	
26		Wire breakage or short-circuit in harness, or contact failure in connector	Check error occurrence, tool data, harness shaking, and conduction with tester.	Sensor 5V system error in addition to above: P0642/4, P0643/3, P1644/2	

No.			Check method	Relevant DTC	Remarks
27	Intermittent fluctuation of cooling-water temperature sensor signal	Wire breakage or short-circuit in cooling-water temperature sensor	Check error occurrence, tool data, and conduction with tester.	Cooling-water temperature sensor system error: P0117/4, P0118/3, P0119/2	
28		Wire breakage or short-circuit in harness, or connector contact failure	Check error occurrence, tool data, and conduction with tester.	Cooling-water temperature sensor system error: P0117/4, P0118/3, P0119/2	
29	Intermittent fluctuation of atmospheric-pressure sensor system	Wire breakage or short-circuit in atmospheric-pressure sensor	Check error occurrence, tool data, and conduction with tester.	Atmospheric-pressure sensor system error: P2228/4, P2229/3, P2230/2	
30		Wire breakage or short-circuit in harness, or connector contact failure	Check error occurrence, tool data, and conduction with tester.	Atmospheric-pressure sensor system error: P2228/4, P2229/3, P2230/2	
31	Intermittent on/off of contact input signal from working machine	Working machine controller failure	Check presence of failure in working machine controller.		
32		Wire breakage or short-circuit in harness, or connector contact failure	Check tool data and conduction with tester.		
33	CAN communication system failure	Communication circuit failure in controller for working machine, Eco-Governor, etc.	Check error occurrence, tool data, and communication status with measuring instrument.	CAN communication error: U0001/12	
34		Wire breakage or short-circuit in harness, or connector contact failure	Check error occurrence, tool data, and conduction with tester.	CAN communication error: U0001/12	
35	Controller system failure	Contact failure of controller connector	Check error occurrence, tool data, harness shaking, and conduction with tester.		
36		Temporary failure in controller input/output circuit	Check occurrence of error.		
37		Program or map data failure	Check program and map data.		
38	Unexpected strong noise or surge	Control system affected by conductive noise	Check presence of conductive noise.		
39		Control system affected by radioactive noise	Check presence of radioactive noise.		

2G-Type Eco-Governor Engine Stalling/Start-Up Inability Factor Analysis

No.				Check method	Relevant DTC	Remarks	
1	Engine stalling/start-up inability	Engine failure	Nozzle failure etc.	Check whole engine.			
2		Working machine failure	Excessive load on working machine	Check whole working machine.			
3		Fuel pump failure	Unstable injection due to defective rack etc.	Check fuel pump.			
4		Dropped supply voltage	Battery system failure		Check error occurrence, tool data, and voltage with voltmeter.	ECU supply voltage system error: P0562/1, P0563/0	
5			Alternator system failure		Check error occurrence, tool data, and voltage with voltmeter.	Battery charging system error: P1562/4, P1568/1	
6			Wire breakage or short-circuit in harness, or connector contact failure		Check error occurrence, tool data, harness shaking, and conduction with tester.	ECU supply voltage system error: P0562/1, P0563/0	
7		Start-assisting heater system failure	Wire breakage or short-circuit in heater		Check conduction of heater.		Occurs only at low temperatures.
8			Wire breakage or short-circuit of heater relay		Check error occurrence, tool data, impact on relay, and conduction with tester.	Start-assisting relay error: P1232/4, P1233/3, P1234/2	
9			Wire breakage or short-circuit in harness, or connector contact failure		Check error occurrence, tool data, harness shaking, and conduction with tester.	Start-assisting relay error: P1232/4, P1233/3, P1234/2	
10		CSD solenoid valve system failure	Wire breakage or short-circuit in CSD solenoid valve		Check conduction of CSD.	CSD solenoid valve system error: P1242/4, P1243/3, P1244/2	
11			Wire breakage or short-circuit in harness, or connector contact failure		Check error occurrence, tool data, harness shaking, and conduction with tester.	CSD solenoid valve system error: P1242/4, P1243/3, P1244/2	
12		EGR step motor system failure	Wire breakage or short-circuit in ECR step motor		Check conduction of ECR step motor.	ECR step motor system error: P1402/4, P1403/3, other phase errors	
13			Wire breakage or short-circuit in harness, or connector contact failure		Check error occurrence, tool data, harness shaking, and conduction with tester.	ECR step motor system error: P1402/4, P1403/3, other phase errors	

No.			Check method	Relevant DTC	Remarks
14	Rack actuator system failure	Rack actuator malfunction due to excessive hysteresis etc.	Check rack actuator operation and hysteresis.	Rack actuator system error: P1212/4, P1213/3, P1211/7	
15		Wire breakage or short-circuit in harness, or connector contact failure	Check error occurrence, tool data, harness shaking, and conduction with tester.	Rack actuator system error: P1212/4, P1213/3, P1211/7	
16	Actuator relay system failure	Contact failure of relay contact	Check error occurrence, tool data, impact on relay, and conduction with tester.	Rack actuator system error: P1212/4, P1213/3, P1211/7	
17		Wire breakage or short-circuit in relay coil	Check error occurrence, tool data, impact on relay, and conduction with tester.	Actuator relay system error: P1222/4, P1223/3, P1224/2	
18		Wire breakage or short-circuit in harness, or connector contact failure	Check error occurrence, tool data, harness shaking, and conduction with tester.	Actuator relay system error: P1222/4, P1223/3, P1224/2	
19	Speed sensor system failure	Reversed polarity of speed sensor harness	Check polarity difference between harness drawing and actual harness.		
20		Wire breakage or short-circuit in speed sensor	Check error occurrence, tool data, and conduction with tester.	Speed sensor system error: P0340/4	
21		Wire breakage or short-circuit in harness, or connector contact failure	Check error occurrence, tool data, harness shaking, and conduction with tester.	Speed sensor system error: P0340/4	
22	Cooling-water temperature sensor system failure	Wire breakage or short-circuit in cooling-water temperature sensor	Check error occurrence, tool data, and conduction with tester.	Cooling-water temperature sensor system error: P0117/4, P0118/3, P0119/2	Occurs only at low temperatures.
23		Wire breakage or short-circuit in harness, or connector contact failure	Check error occurrence, tool data, and conduction with tester.	Cooling-water temperature sensor system error: P0117/4, P0118/3, P0119/2	
24	Atmospheric-pressure sensor system failure	Wire breakage or short-circuit in atmospheric-pressure sensor	Check error occurrence, tool data, and conduction with tester.	Atmospheric-pressure sensor system error: P2228/4, P2229/3, P2230/2	
25		Wire breakage or short-circuit in harness, or connector contact failure	Check error occurrence, tool data, and conduction with tester.	Atmospheric-pressure sensor system error: P2228/4, P2229/3, P2230/2	
26	Invalid contact input signal from working machine	Working machine controller failure	Check presence of failure in working machine controller.		
27		Wire breakage or short-circuit in harness, or connector contact failure	Check tool data and conduction with tester.		

No.			Check method	Relevant DTC	Remarks
28	CAN communication system failure	Communication circuit failure in controller for working machine, Eco-Governor, etc.	Check error occurrence, tool data, and communication status with measuring instrument.	CAN communication error: U0001/12	
29		Wire breakage or short-circuit in harness, or connector contact failure	Check error occurrence, tool data, and conduction with tester.	CAN communication error: U0001/12	
30	Controller system failure	Contact failure of controller connector	Check error occurrence, tool data, harness shaking, and conduction with tester.		
31		Temporary failure in controller input/output circuit	Check occurrence of error.		
32		Program or map data failure	Check program and map data.		
33	Unexpected strong noise or surge	Control system affected by conductive noise	Check presence of conductive noise.		
34		Control system affected by radioactive noise	Check presence of radioactive noise.		

2G-Type Eco-Governor Black Smoke Factor Analysis

No.				Check method	Relevant DTC	Remarks
1	Black-smoke emission from engine	Insufficient fuel supply	Fuel pipe clogging	Check fuel system.		
2		Engine failure	Nozzle failure etc.	Check whole engine.		
3		Working machine failure	Load fluctuation in working machine	Check whole working machine.		
4		Fuel pump failure	Unstable injection due to defective rack etc.	Check fuel pump.		
5		CSD solenoid valve system failure	Wire breakage or short-circuit in CSD solenoid valve	Check conduction of CSD.	CSD solenoid valve system error: P1242/4, P1243/3, P1244/2	
6			Wire breakage or short-circuit in harness, or connector contact failure	Check error occurrence, tool data, harness shaking, and conduction with tester.	CSD solenoid valve system error: P1242/4, P1243/3, P1244/2	
7		EGR step motor system failure	Wire breakage or short-circuit in ECR step motor	Check conduction of ECR step motor.	ECR step motor system error: P1402/4, P1403/3, other phase errors	
8			Wire breakage or short-circuit in harness, or connector contact failure	Check error occurrence, tool data, harness shaking, and conduction with tester.	ECR step motor system error: P1402/4, P1403/3, other phase errors	
9		Rack actuator system failure	Rack actuator malfunction due to excessive hysteresis etc.	Check rack actuator operation and hysteresis.	Rack actuator system error: P1212/4, P1213/3, P1211/7	
10			Wire breakage or short-circuit in harness, or connector contact failure	Check error occurrence, tool data, harness shaking, and conduction with tester.	Rack actuator system error: P1212/4, P1213/3, P1211/7	
11		Atmospheric-pressure sensor system failure	Wire breakage or short-circuit in atmospheric-pressure sensor	Check error occurrence, tool data, and conduction with tester.	Atmospheric-pressure sensor system error: P2228/4, P2229/3, P2230/2	
12			Wire breakage or short-circuit in harness, or connector contact failure	Check error occurrence, tool data, and conduction with tester.	Atmospheric-pressure sensor system error: P2228/4, P2229/3, P2230/2	

No.			Check method	Relevant DTC	Remarks
13	Controller system failure	Temporary failure in controller input/output circuit	Check occurrence of error.		
14		Program or map data failure	Check program and map data.		
15	Unexpected strong noise or surge	Control system affected by conductive noise	Check presence of conductive noise.		
16		Control system affected by radioactive noise	Check presence of radioactive noise.		

This Page Intentionally Left Blank

YANMAR®

**Head Office:
Yanmar Co., Ltd.**

1-32 Chayamachi, Kita-ku, Osaka 530-8311, Japan
<http://www.yanmar.co.jp>

Yanmar America Corporation

951 Corporate Grove Drive
Buffalo Grove, IL 60089-4508, U.S.A.
TEL: 1-847-541-1900 FAX: 1-847-541-2161
<http://www.yanmar.com>

Yanmar Europe B.V.

Brugplein11, 1332 BS Almere -de Vaart,
The Netherlands.
TEL: 31-36-5493200 FAX: 31-36-5493209
<http://www.yanmar.nl>

Yanmar Asia (Singapore) Corporation Pte. Ltd.

4 Tuas Lane, Singapore 638613
TEL: 65-68615077 FAX: 65-68611509
<http://www.yanmar.co.jp/yasc/>

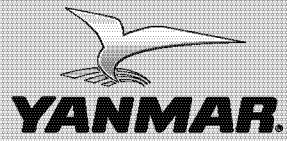

YANMAR CO., LTD.