

Toro®

TITAN TINES

2012 Catalog



Count on it.

Toro[®]

TITAN[®] TINES

2012 Catalog



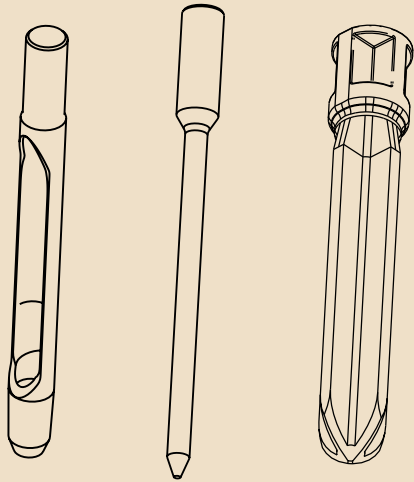

Toro®
TITAN®
TINES
 2012 Catalog

Table of Contents

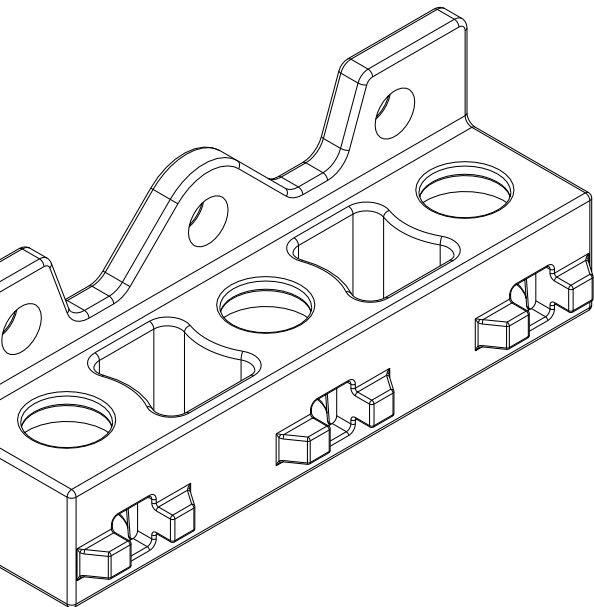
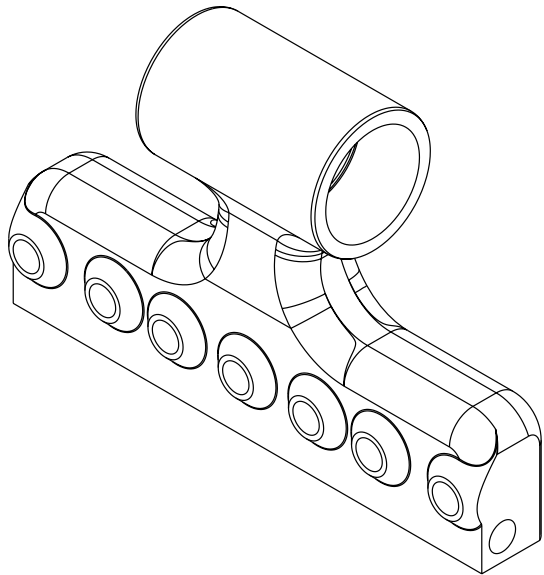

AERATION IMPROVES TURF CONDITIONS 1
A TINE TO FIT EVERY APPLICATION 2
MEASUREMENT GUIDE 3
TINE HEAD IDENTIFICATION GUIDE 4
AERATION EVALUATION GUIDE 5-6
PROCORE® 648 7-13
PROCORE® 864/1298 15-21
PROCORE® 440/660/880 23-27
TURF AERATOR 686/687 28
GREENS AERATOR 29-32
FAIRWAY AERATOR 33-36
PROCORE® SR SERIES 37-49
 SR48 38-39
 SR54 40
 SR54-S 41-42
 SR70 43
 SR70-S 44-45
 SR72 46-47
 SR75 48-49
TITAN® TINE CONVERSION SLEEVES 50
TITAN® TINES FOR COMPETITIVE MODELS 50-54
INDEX 55-57

Aeration Improves Turf

CONDITIONS



Aeration keeps your turf looking great. It's important to aerate often, especially when it comes to high traffic areas, and with **TITAN® TINES** on your team you'll know you have the best equipment to meet all of your aeration needs successfully.

A Tine To Fit Every Application

Toro® has about every possible tine you can imagine for the changing seasons and your most demanding turf conditions. TITAN® Tines offer superior quality to provide your grounds the best possible care.

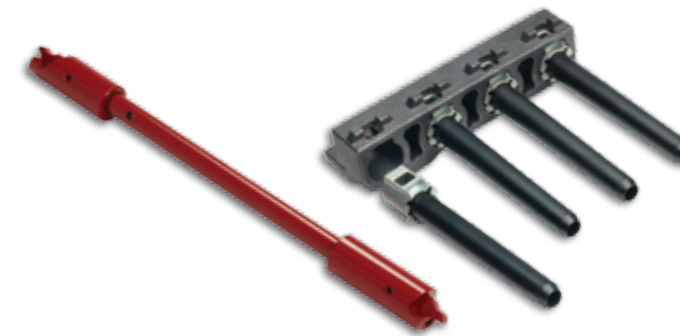

Jump-start your productivity with the TITAN QuickChange™ tine head. The patent-pending taper-lock design makes changing tines a snap. In fact, many users have reduced set-up time by up to 75%. TITAN QuickChange will help you get your aeration done FAST!

Toro TITAN Tines Offer

- Over 150 tines, providing multiple aeration choices
- A wide variety of types meeting your exact aeration requirements
- Higher Productivity: TITAN Max designed with long lasting tungsten carbide blend tip
- Better Performance: TITAN tines last approximately 3-4 times longer than standard tines
- An optimized core, removing more thatch for maximum topdressing
- A superior hole, improving recovery time and maintaining playability
- A tough design, maintaining consistent aeration depth and reducing costly change outs
- 4130/4140 strong alloy combined with unique heat treat process, maximizing strength and resistance to wear
- Durable brazed tip joints for strong bond and resistance to separation and breakage (TITAN Max)

Toro's Family Of Tines Are Designed To Meet Your Exact Aeration Need

TINE	TIP	LONGEVITY	APPLICATION	WALL THICKNESS
Toro Classic	Standard durable heat treated tip	Good	Good quality in most turf conditions	Thin wall delivers durability and exceptional performance
TITAN	Sharp heat treated tip for improved hole quality and life	Better	Provides superior performance and long lasting wear in most turf conditions	Thin wall delivers durability and exceptional performance
TITAN Max	Sharp carbide tip for excellent hole quality and life	Best	Provides superior performance and long lasting wear in most conditions	Thin wall delivers durability and exceptional performance
TITAN Fairway	Standard heat treated fairway tip for consistent core removal	Better	Provides quality performance in natural soil conditions	Thicker wall provides good hole quality and maximum strength
TITAN HD Fairway	Enhanced hardened tip for 75% longer life than TITAN Fairway	Best	Provides excellent performance and wear in extreme conditions	Thicker wall provides good hole quality and maximum strength

CORING TINES



SOLID TINES







Measurement Guide

SELECTION & MEASUREMENT



GENUINE TORO PARTS

U.S. Standard Sizes

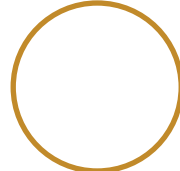
- 1/4" (.25") 
- 3/8" (.375") 
- 1/2" (.5") 
- 5/8" (.625") 
- 3/4" (.75") 
- 7/8" (.875") 

TITAN® TINES fit all current and late model Toro® aerators. Standard mount size fits most competitor equipment. Check mounting size to ensure compatibility. Prices subject to change without notice.

Tine Head Identification Guide

ProCore 648/864/1298 (See pages 7-13, 15-21)

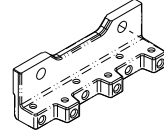
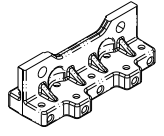
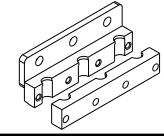
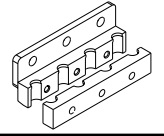
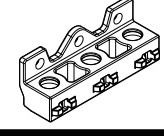
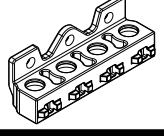
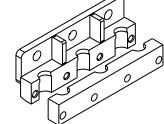
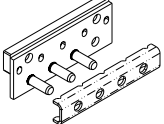
	QUAD TINE HEAD (1x6) Tine Mount: 3/8" Qty. of Tines: 6		QUAD TINE HEAD (2x5) Tine Mount: 3/8" Qty. of Tines: 10
	3/4" 3-TINE HEAD Tine Mount: 3/4" Qty. of Tines: 3		3/4" 4-TINE HEAD Tine Mount: 3/4" Qty. of Tines: 4
	QUICKCHANGE 3-TINE HEAD Tine Mount: 3/4" or 7/8" Qty. of Tines: 3		QUICKCHANGE 4-TINE HEAD Tine Mount: 3/4" or 7/8" Qty. of Tines: 4
	7/8" 3-TINE HD HEAD Tine Mount: 7/8" Qty. of Tines: 3		NEEDLE TINE HEAD Tine Mount: Needle Qty. of Tines: 5

ProCore 440/660/880 (See pages 23-27)

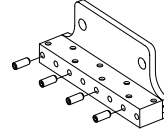
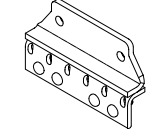
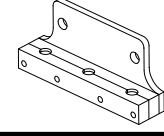
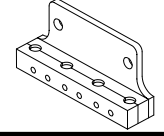
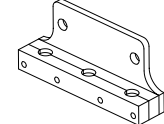
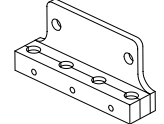
	QUAD TINE HEAD (1x6) Tine Mount: 3/8" Qty. of Tines: 8		NEEDLE TINE HEAD Tine Mount: Needle Qty. of Tines: 6
	3/4" 3-TINE HEAD Tine Mount: 3/4" Qty. of Tines: 3		3/4" 4-TINE HEAD Tine Mount: 3/4" Qty. of Tines: 4
	7/8" 3-TINE HEAD Tine Mount: 7/8" Qty. of Tines: 3		7/8" 4-TINE HEAD Tine Mount: 7/8" Qty. of Tines: 4

ProCore SR Series (See pages 40-51)

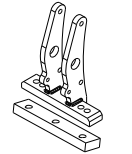
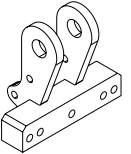
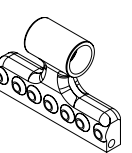
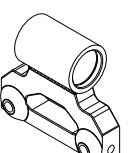
	SR54-S / SR70-S Tine Mount: 5/16" or 12mm Qty. of Tines: 3		SR54 / SR70 Tine Mount: 5/16" or 12mm Qty. of Tines: 2 or 3
	SR48 / SR72 Tine Mount: 12mm or 18mm Qty. of Tines: 3 or 4		SR75 Tine Mount: 7/8" or 18mm Qty. of Tines: 2

Aeration Evaluation Guide

DETERMINE the total surface area affected and amount of material removed.

STEP ONE

The first step is to find holes per square foot. If you know your lateral and forward spacing, find holes per square foot on the **Holes Per Square Foot** table.

Example:

- **Lateral Spacing = 2.00**
- **Forward Spacing = 2.00**
- **Holes Per Square Foot = 36.00**

If you are not sure of your forward and lateral spacing, but know your aerator model number go to the **Pick A Model** table and pick your spacing options. This table will also help you determine the proper turf holder based on your tine configuration.

* Tine depth can vary based on machine set-up.

STEP TWO

To determine the total surface area affected and volume of soil removed when aerating, reference the **Percent Surface Area Affected/Volume Removed** table. All you need to know is holes per square foot, core diameter (ID), and the depth* at which you are aerating.

Example:

- **Holes Per Square Feet = 36.00**
- **Core Diameter = .300"**
- **Depth = 3.0**
- **Percent Surface Area Affected = 1.77%**
- **Volume Removed = 4.42 cu-ft per 1,000 sq/ft**



Helping Golf Course Superintendents and Groundskeepers Excel.

When you're looking to keep your golf course and grounds in top shape, you need a system that helps you quickly choose the right treatment for your turf needs.

Aeration is the key and the tine selection chart offers you fast answers that convey exactly what you need to do to keep your turf looking great.

The tine selection guide makes it easy to choose and understand the right solution for your golf course and ground needs!

The benefits of using the tine selection chart include:

- Speed and ease of use
- Selection of proper turf guard based on aerator and tine configuration needs.
- Quickly identify the amount of soil removed and the percentage of surface area affected



ProCore® 648

FEATURES & BENEFITS

- 48 inch wide aeration swath
- TrueCore™ ground following system
- Inside wheel placement
- Precision balanced head drive
- RotaLink™ tine guide mechanism
- Series/Parallel 3-wheel drive



The **ProCore 648** is an innovative walking aerator from Toro. The rear wheels are within the 48" aeration swath of the machine so the tines are not running over freshly aerated turf. This eliminates the problem of smashing the cores into the holes, preventing topdressing from filling the holes. And easier cleanup produces a savings of time and labor.

TINE HEADS		TINES REQ'D	TURF GUARDS			
Description	Part No.		Part No.	Qty.	Part No.	Qty.
Needle Tine Head	09739	30				
Quad Tine 3/8" Mount Head, 2 rows of 5	09736	60	120-1047	2	120-1052	1
Quad Tine 3/8" Mount Head, 1 row of 6	09737	36	110-4369	2	110-4370	1
3 Tine, 3/4" Mount Head	09794	18	120-1044	2	110-4358	1
4 Tine, 3/4" Mount Head	09796	24	110-4361	2	110-4362	1
3 Tine HD, 7/8" Mount Head	09797	18	120-1044	2	110-4358	1
3 Tine, Titan 3/4" or 7/8" Mount QuickChange Head	09711	18	120-1044	2	110-4358	1
4 Tine, Titan 3/4" or 7/8" Mount QuickChange Head	09719	24	110-4361	2	110-4362	1

ProCore 648
3/8 Mounting Size **TITAN® MAX**

	Length	Core Dia. (ID)	OD	Wall Thickness	Part Number	Price	Part Number	Core Dia. (ID)	Price	
TITAN QUAD							QUAD MAX			
	4.50"	.25"	.36"	.052"	108-9104	\$6.34	108-9112	.23"	\$11.62	
	4.50"	.32"	.46"	.063"	108-9105	\$7.66	108-9114	.28"	\$12.03	
	4.50"	.41"	.55"	.063"	108-9106	\$8.17	108-9116	.38"	\$12.13	
	4.50"	.48"	.58"	.063"	108-9293	\$8.07				
	5.00"	.25"	.36"	.052"	108-9108	\$6.34	108-9120	.23"	\$11.57	
	5.00"	.32"	.46"	.063"	108-9109	\$7.66	108-9122	.28"	\$12.03	
	5.00"	.41"	.55"	.063"	108-9110	\$8.17	108-9124	.38"	\$11.98	
	5.00"	.48"	.58"	.063"	108-9294	\$8.32				
	5.50"	.41"	.55"	.063"	108-9290	\$9.19				

	Length	Core Dia. (ID)	OD	Wall Thickness	Part Number	Price				
TITAN SOLID ROUND										
	4.50"	-	.20"	-	108-9230	\$4.31				
	4.50"	-	.25"	-	108-9231	\$4.36				
	4.50"	-	.30"	-	108-9232	\$4.36				
	4.50"	-	.38"	-	108-9233	\$4.42				
	5.50"	-	.20"	-	108-9234	\$4.57				
	5.50"	-	.25"	-	108-9235	\$4.62				
	5.50"	-	.30"	-	108-9236	\$4.62				
	5.50"	-	.38"	-	108-9237	\$4.64				

	Length	Core Dia. (ID)	OD	Wall Thickness	Part Number	Price				
TITAN SOLID SLICING										
	5.00"	-	.63"	-	108-9238	\$11.17				

	Length	Core Dia. (ID)	OD	Wall Thickness	Part Number	Price	Part Number	Core Dia. (ID)	Price	
TITAN CROSS							CROSS MAX			
	4.50"	-	.38"	-	108-9215	\$7.76				
	4.50"	-	.50"	-	108-9216	\$8.07	112-1310	-	\$14.36	
	4.50"	-	.62"	-	108-9217	\$8.37				
	5.50"	-	.38"	-	108-9218	\$9.29				
	5.50"	-	.50"	-	108-9219	\$9.64	112-1311	-	\$14.67	
	5.50"	-	.62"	-	108-9220	\$10.00				

ProCore 648

3/4 Mounting Size

TITAN® MAX

Length	Core Dia. (ID)	OD	Wall Thickness	Part Number	Price	Part Number	Core Dia. (ID)	Price
TITAN HOLLOW						HOLLOW MAX		
4.75"	.28"	.46"	.058"	108-9128	\$4.31	108-9139	.28"	\$10.20
4.75"	.41"	.56"	.058"	108-9129	\$4.47	108-9141	.38"	\$10.40
4.75"	.53"	.66"	.058"	108-9130	\$4.31	108-9143	.48"	\$10.20
5.75"	.28"	.46"	.058"	108-9132	\$4.67	108-9145	.28"	\$10.76
5.75"	.41"	.56"	.058"	108-9133	\$4.57	108-9147	.38"	\$10.76
5.75"	.53"	.66"	.058"	108-9134	\$4.57	108-9149	.48"	\$11.57
6.50"	.28"	.46"	.058"	108-9138	\$4.82	108-9135	.28"	\$11.67
6.50"	.41"	.56"	.058"	108-9136	\$4.87	108-9151	.38"	\$10.81
6.50"	.53"	.66"	.058"	108-9137	\$4.87	108-9153	.48"	\$11.47

TITAN HOLLOW - EXTENDED TAPER

EXTENDED TAPER MAX

5.75"	.53"	.66"	.058"	114-0551	\$4.52	114-0553	.47"	\$10.76
6.50"	.53"	.66"	.058"	114-0550	\$4.82	114-0561	.47"	\$10.91

TITAN SIDE EJECT

TITAN SIDE EJECT MAX

4.75"	.28"	.46"	.055"	108-9159	\$5.53	108-9170	.28"	\$13.04
4.75"	.41"	.56"	.058"	108-9160	\$5.63	108-9172	.38"	\$13.04
4.75"	.53"	.66"	.058"	108-9161	\$5.63	108-9174	.48"	\$13.04
5.75"	.28"	.46"	.055"	108-9163	\$5.73	108-9176	.28"	\$13.45
5.75"	.41"	.56"	.058"	108-9164	\$5.73	108-9178	.38"	\$13.55
5.75"	.53"	.66"	.058"	108-9165	\$5.94	108-9180	.48"	\$13.60
6.50"	.28"	.46"	.055"	108-9162	\$6.34	108-9166	.28"	\$14.41
6.50"	.41"	.56"	.058"	108-9167	\$6.45	108-9182	.38"	\$14.67
6.50"	.53"	.66"	.058"	108-9168	\$6.45	108-9184	.48"	\$14.51

TITAN SIDE EJECT - EXTENDED TAPER

EXTENDED TAPER MAX

5.75"	.53"	.66"	.058"	114-0555	\$5.73	114-0557	.47"	\$13.55
6.50"	.53"	.66"	.058"	114-0558	\$6.34	114-0560	.47"	\$14.46

TITAN SPLIT TINE

5.75"	.51"	.88"	.120"	112-5122	\$7.87
-------	------	------	-------	----------	--------

ProCore 648

3/4 Mounting Size (cont.)

TITAN® MAX



Length	Core Dia. (ID)	OD	Wall Thickness	Part Number	Price	Part Number	Core Dia. (ID)	Price
TITAN HD FAIRWAY								
5.75"	.51"	.70"	.122"	108-9260	\$6.80			
5.75"	.51"	.80"	.122"	108-9261	\$7.21			
TITAN FAIRWAY								
5.75"	.51"	.77"	.120"	104-9876	\$4.16			
5.75"	.51"	.88"	.120"	104-9875	\$4.16			
CLASSIC								
4.75"	.30"	.44"	.035"	59-3690	\$1.57			
4.75"	.40"	.50"	.049"	66-9140	\$1.57			
4.75"	.50"	.63"	.049"	59-3670	\$1.80			
5.75"	.51"	.63"	.058"	104-0984	\$2.94			
6.50"	.51"	.63"	.058"	106-8943	\$2.54			
6.50"	.57"	.66"	.058"	105-1180	\$2.74			
TITAN SOLID ROUND								
4.50"	-	.25"	-	108-9198	\$4.77			
4.50"	-	.30"	-	108-9199	\$4.77			
4.50"	-	.35"	-	108-9200	\$4.87			
4.50"	-	.40"	-	108-9201	\$4.77			
4.50"	-	.50"	-	108-9202	\$4.77			
4.50"	-	.60"	-	108-9203	\$4.77			
5.50"	-	.25"	-	108-9204	\$4.97			
5.50"	-	.30"	-	108-9205	\$4.87			
5.50"	-	.35"	-	108-9206	\$4.82			
5.50"	-	.40"	-	108-9207	\$4.87			
5.50"	-	.50"	-	108-9208	\$4.87			
5.50"	-	.60"	-	108-9209	\$4.97			
5.50"	-	.75"	-	108-9244	\$4.77			

ProCore® 648 3/4 Mounting Size TITAN Solid Round continued on the next page. >

ProCore 648

3/4 Mounting Size (cont.)

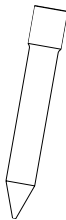

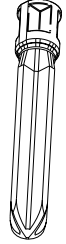

TITAN® MAX

Length	Core Dia. (ID)	OD	Wall Thickness	Part Number	Price	Part Number	Core Dia. (ID)	Price
TITAN SOLID ROUND (cont.)								
	6.50"	-	.30"	-	108-9210	\$5.53		
	6.50"	-	.35"	-	108-9211	\$5.38		
	6.50"	-	.40"	-	108-9212	\$5.53		
	6.50"	-	.50"	-	108-9213	\$5.53		
	6.50"	-	.60"	-	108-9214	\$5.53		
	6.50"	-	.75"	-	108-9245	\$4.87		
TITAN SOLID SLICING								
	4.50"	-	.75"	-	108-9239	\$10.61		
	5.50"	-	.75"	-	108-9240	\$10.91		
	6.50"	-	.75"	-	108-9241	\$11.47		
TITAN CROSS								
	4.50"	-	.50"	-	108-9221	\$8.63	112-1312	\$15.48
	4.50"	-	.63"	-	108-9222	\$8.93		
	4.50"	-	.75"	-	108-9223	\$9.24		
	5.50"	-	.50"	-	108-9224	\$8.88	112-1313	\$15.48
	5.50"	-	.63"	-	108-9225	\$9.19		
	5.50"	-	.75"	-	108-9226	\$9.54		
	6.50"	-	.50"	-	108-9227	\$9.14	112-1314	\$15.38
	6.50"	-	.62"	-	108-9228	\$9.54		
	6.50"	-	.75"	-	108-9229	\$9.85		

ProCore 648

7/8 Mounting Size

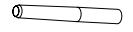
TITAN® MAX





Length	Core Dia. (ID)	OD	Wall Thickness	Part Number	Price	Part Number	Core Dia. (ID)	Price
TITAN HOLLOW								
	4.75"	.51"	.66"	.058"	108-9190	\$4.42	108-9155	\$10.91
	4.75"	.63"	.76"	.058"	108-9191	\$4.42		
	5.75"	.51"	.66"	.058"	108-9192	\$4.77	108-9157	\$11.37
	5.75"	.63"	.76"	.058"	108-9193	\$4.87		
TITAN SIDE EJECT								
	4.75"	.51"	.66"	.058"	108-9194	\$5.63	108-9186	\$13.35
	4.75"	.63"	.76"	.058"	108-9195	\$5.63		
	5.75"	.51"	.66"	.058"	108-9196	\$6.14	108-9188	\$14.11
	5.75"	.63"	.76"	.058"	108-9197	\$5.94		
TITAN SPLIT								
	5.75"	.64"	.88"	.120"	112-5121	\$7.11		
	5.75"	.64"	.92"	.120"	112-5123	\$7.41		
CLASSIC								
	4.75"	.60"	.75"	.065"	62-4600	\$2.18		
	5.75"	.60"	.75"	.065"	86-9720	\$2.84		
TITAN FAIRWAY HD								
	5.75"	.64"	.80"	.122"	108-9264	\$8.27		
	5.75"	.64"	.92"	.122"	108-9265	\$7.92		
TITAN FAIRWAY								
	4.75"	.64"	.80"	.122"	92-7941	\$3.35		
	5.75"	.64"	.80"	.122"	92-7900	\$4.87		
	5.75"	.64"	.92"	.120"	104-9877	\$4.31		

ProCore® 648

ProCore 648

7/8 Mounting Size (cont.)

TITAN® MAX

	Length	Core Dia. (ID)	OD	Wall Thickness	Part Number	Price	Part Number	Core Dia. (ID)	Price
TITAN SOLID ROUND									
	5.50"	-	.75"	-	108-9246	\$7.05			
	5.50"	-	.88"	-	108-9247	\$8.12			
	6.50"	-	.75"	-	108-9248	\$9.49			
	6.50"	-	.88"	-	108-9249	\$9.74			
TITAN SOLID SLICING									
	5.50"	-	.75"	-	108-9242	\$11.72			
	6.50"	-	.75"	-	108-9243	\$13.09			
TITAN CROSS									
	5.50"	-	.88"	-	108-9259	\$12.08			
NEEDLE TINE									
	6.43"	-	5mm	-	100-3620	\$4.01			Requires Needle Tine Head
	7.38"	-	8mm	-	100-3621	\$4.11			Requires Needle Tine Head

TLC™

Toro Loyalty Counts PARTS REWARD PROGRAM



Toro Loyalty Counts Parts Rewards Program was developed specifically to reward **you—our customer**. Earn points based on your parts purchases of tires, tines, bedknives, bearings, belts and filters.

We Made A Good Thing Great.

New benefits for the program include a new web site, new rewards, and bigger earnings.



Many more options available than what is shown.

**Enroll and start earning reward points immediately.
Rewards are available for as few as 100 points!**

For more information, contact your local Toro distributor at **1 (800) 803-8676** or visit **www.toro.com/tlc**



Count on it.

ProCore®

864/1298



FEATURES & BENEFITS

- Precision-balanced coring heads
- RotaLink™ tine guide system
- Efficient aeration
- Smooth, quiet, powerful operation
- Impact resistance system

The same ground-breaking technology that allowed the ProCore 648 to revolutionize greens aeration is now available for large-area applications in the new **ProCore 864** and **1298**. Aerate fairways and sports fields in efficient 64" (162.9cm) and 98" (248.9cm) swaths with smooth operation and precision performance you demand.

GENUINE TORO PARTS

ProCore® 864/1298

ProCore 864/1298

3/8 Mounting Size

TITAN® MAX

Length	Core Dia. (ID)	OD	Wall Thickness	Part Number	Price	Part Number	Core Dia. (ID)	Price
TITAN QUAD						QUAD MAX		
4.50"	.25"	.36"	.052"	108-9104	\$6.34	108-9112	.23"	\$11.62
4.50"	.32"	.46"	.063"	108-9105	\$7.66	108-9114	.28"	\$12.03
4.50"	.41"	.55"	.063"	108-9106	\$8.17	108-9116	.38"	\$12.13
4.50"	.48"	.58"	.063"	108-9293	\$8.07			
5.00"	.25"	.36"	.052"	108-9108	\$6.34	108-9120	.23"	\$11.57
5.00"	.32"	.46"	.063"	108-9109	\$7.66	108-9122	.28"	\$12.03
5.00"	.41"	.55"	.063"	108-9110	\$8.17	108-9124	.38"	\$11.98
5.00"	.48"	.58"	.063"	108-9294	\$8.32			
5.50"	.41"	.55"	.063"	108-9290	\$9.19			



TITAN SOLID ROUND

4.50"	-	.20"	-	108-9230	\$4.31			
4.50"	-	.25"	-	108-9231	\$4.36			
4.50"	-	.30"	-	108-9232	\$4.36			
4.50"	-	.38"	-	108-9233	\$4.42			
5.50"	-	.20"	-	108-9234	\$4.57			
5.50"	-	.25"	-	108-9235	\$4.62			
5.50"	-	.30"	-	108-9236	\$4.62			
5.50"	-	.38"	-	108-9237	\$4.64			



TITAN SOLID SLICING

5.00"	-	.63"	-	108-9238	\$11.17			
-------	---	------	---	----------	---------	--	--	--



TITAN CROSS

4.50"	-	.38"	-	108-9215	\$7.76			
4.50"	-	.50"	-	108-9216	\$8.07	112-1310	-	\$14.36
4.50"	-	.62"	-	108-9217	\$8.37			
5.50"	-	.38"	-	108-9218	\$9.29			
5.50"	-	.50"	-	108-9219	\$9.64	112-1311	-	\$14.67
5.50"	-	.62"	-	108-9220	\$10.00			



TINE HEADS		TINES REQ'D		TURF GUARDS		
Description	Part No.	Qty. 864	Qty. 1298	Part No.	Qty. 864	Qty. 1298
Quad Tine Head, 2 rows of 5 3/8" Mount	09736	80	120	120-1047 120-1052 110-4367 110-4368	2 - 1 1	4 2 - -
Quad Tine Head, 1 row of 6 3/8" Mount	09737	48	72	110-4369 110-4370 115-2801 115-2802	2 - 1 1	4 2 - -
4 Tine TITAN QuickChange 3/4" or 7/8" Sleeve	09719	32	48	120-1045 120-1046 110-4363 110-4364	2 - 1 1	4 2 - -
3 Tine TITAN QuickChange 3/4" or 7/8" Sleeve	09711	24	36	120-1044 110-4358 110-4359 110-4360	2 - 1 1	4 2 - -

TINE HEADS		TINES REQ'D		TURF GUARDS		
Description	Part No.	Qty. 864	Qty. 1298	Part No.	Qty. 864	Qty. 1298
Needle Tine Head	09739	40	60	120-1047 120-1052 110-4367 110-4368	2 - 1 1	4 2 - -
3 Tine Head 3/4" Mount	09794	24	36	120-1044 110-4358 115-4359 115-4360	2 - 1 1	4 2 - -
4 Tine Head 3/4" Mount	09796	32	48	120-1045 120-1046 110-4363 110-4364	2 - 1 1	4 2 - -
3 Tine Head HD 7/8" Mount	09797	24	36	120-1044 110-4358 110-4359 110-4360	2 - 1 1	4 2 - -

ProCore 864/1298
3/4 Mounting Size **TITAN® MAX**

Length	Core Dia. (ID)	OD	Wall Thickness	Part Number	Price	Part Number	Core Dia. (ID)	Price
TITAN HOLLOW						HOLLOW MAX		
4.75"	.28"	.46"	.058"	108-9128	\$4.31	108-9139	.28"	\$10.20
4.75"	.41"	.56"	.058"	108-9129	\$4.47	108-9141	.38"	\$10.40
4.75"	.53"	.66"	.058"	108-9130	\$4.31	108-9143	.48"	\$10.20
5.75"	.28"	.46"	.058"	108-9132	\$4.67	108-9145	.28"	\$10.76
5.75"	.41"	.56"	.058"	108-9133	\$4.57	108-9147	.38"	\$10.76
5.75"	.53"	.66"	.058"	108-9134	\$4.57	108-9149	.48"	\$11.57
6.50"	.28"	.46"	.058"	108-9138	\$4.82	108-9135	.28"	\$11.67
6.50"	.41"	.56"	.058"	108-9136	\$4.87	108-9151	.38"	\$10.81
6.50"	.53"	.66"	.058"	108-9137	\$4.87	108-9153	.48"	\$11.47



Length	Core Dia. (ID)	OD	Wall Thickness	Part Number	Price	Part Number	Core Dia. (ID)	Price
TITAN HOLLOW EXT. TAPER						HOLLOW EXT. TAPER MAX		
5.75"	.53"	.66"	.058"	114-0551	\$4.52	114-0553	.47"	\$10.76
6.50"	.53"	.66"	.058"	114-0550	\$4.82	114-0561	.47"	\$10.91



Length	Core Dia. (ID)	OD	Wall Thickness	Part Number	Price	Part Number	Core Dia. (ID)	Price
TITAN SIDE EJECT						SIDE EJECT MAX		
4.75"	.28"	.46"	.055"	108-9159	\$5.53	108-9170	.28"	\$13.04
4.75"	.41"	.56"	.058"	108-9160	\$5.63	108-9172	.38"	\$13.04
4.75"	.53"	.66"	.058"	108-9161	\$5.63	108-9174	.48"	\$13.04
5.75"	.28"	.46"	.055"	108-9163	\$5.73	108-9176	.28"	\$13.45
5.75"	.41"	.56"	.058"	108-9164	\$5.73	108-9178	.38"	\$13.55
5.75"	.53"	.66"	.058"	108-9165	\$5.94	108-9180	.48"	\$13.60
6.50"	.28"	.46"	.055"	108-9162	\$6.34	108-9166	.28"	\$14.41
6.50"	.41"	.56"	.058"	108-9167	\$6.45	108-9182	.38"	\$14.67
6.50"	.53"	.66"	.058"	108-9168	\$6.45	108-9184	.48"	\$14.51



Length	Core Dia. (ID)	OD	Wall Thickness	Part Number	Price	Part Number	Core Dia. (ID)	Price
TITAN SIDE EJECT EXT. TAPER						SIDE EJECT EXT. TAPER MAX		
5.75"	.53"	.66"	.058"	114-0555	\$5.73	114-0557	.47"	\$13.55
6.50"	.53"	.66"	.058"	114-0558	\$6.34	114-0560	.47"	\$14.46



Length	Core Dia. (ID)	OD	Wall Thickness	Part Number	Price
TITAN SPLIT					
5.75"	.51"	.88"	.120"	112-5122	\$7.87



ProCore 864/1298
3/4 Mounting Size (cont.) **TITAN® MAX**

Length	Core Dia. (ID)	OD	Wall Thickness	Part Number	Price	Part Number	Core Dia. (ID)	Price
TITAN FAIRWAY HD								
5.75"	.51"	.70"	.122"	108-9260	\$6.80			
5.75"	.51"	.80"	.122"	108-9261	\$7.21			
TITAN FAIRWAY								
5.75"	.51"	.77"	.120"	104-9876	\$4.16			
5.75"	.51"	.88"	.120"	104-9875	\$4.16			
CLASSIC								
4.75"	.30"	.44"	.035"	59-3690	\$1.57			
4.75"	.40"	.50"	.049"	66-9140	\$1.57			
4.75"	.50"	.63"	.049"	59-3670	\$1.80			
5.75"	.51"	.63"	.058"	104-0984	\$2.94			
6.50"	.51"	.63"	.058"	106-8943	\$2.54			
6.50"	.57"	.66"	.058"	105-1180	\$2.74			
TITAN SOLID ROUND								
4.50"	-	.25"	-	108-9198	\$4.77			
4.50"	-	.30"	-	108-9199	\$4.77			
4.50"	-	.35"	-	108-9200	\$4.87			
4.50"	-	.40"	-	108-9201	\$4.77			
4.50"	-	.50"	-	108-9202	\$4.77			
4.50"	-	.60"	-	108-9203	\$4.77			
5.50"	-	.25"	-	108-9204	\$4.97			
5.50"	-	.30"	-	108-9205	\$4.87			
5.50"	-	.35"	-	108-9206	\$4.82			
5.50"	-	.40"	-	108-9207	\$4.87			
5.50"	-	.50"	-	108-9208	\$4.87			
5.50"	-	.60"	-	108-9209	\$4.97			
5.50"	-	.75"	-	108-9244	\$4.77			

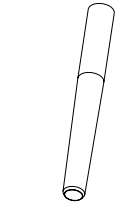

ProCore® 864/1298 3/4 Mounting Size TITAN Solid Round continued on the next page. >

ProCore 864/1298

3/4 Mounting Size (cont.) **TITAN® MAX**

Length	Core Dia. (ID)	OD	Wall Thickness	Part Number	Price	Part Number	Core Dia. (ID)	Price
--------	----------------	----	----------------	-------------	-------	-------------	----------------	-------

TITAN SOLID ROUND (cont.)

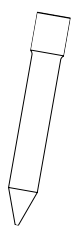

6.50"	-	.30"	-	108-9210	\$5.53			
6.50"	-	.35"	-	108-9211	\$5.38			
6.50"	-	.40"	-	108-9212	\$5.53			
6.50"	-	.50"	-	108-9213	\$5.53			
6.50"	-	.60"	-	108-9214	\$5.53			
6.50"	-	.75"	-	108-9245	\$4.87			

TITAN SOLID SLICING

4.50"	-	.75"	-	108-9239	\$10.61			
5.50"	-	.75"	-	108-9240	\$10.91			
6.50"	-	.75"	-	108-9241	\$11.47			

TITAN CROSS **CROSS MAX**

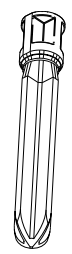

4.50"	-	.50"	-	108-9221	\$8.63	112-1312	-	\$15.48
4.50"	-	.63"	-	108-9222	\$8.93			
4.50"	-	.75"	-	108-9223	\$9.24			
5.50"	-	.50"	-	108-9224	\$8.88	112-1313	-	\$15.48
5.50"	-	.63"	-	108-9225	\$9.19			
5.50"	-	.75"	-	108-9226	\$9.54			
6.50"	-	.50"	-	108-9227	\$9.14	112-1314	-	\$15.38
6.50"	-	.62"	-	108-9228	\$9.54			
6.50"	-	.75"	-	108-9229	\$9.85			

ProCore 864/1298

7/8 Mounting Size **TITAN® MAX**

Length	Core Dia. (ID)	OD	Wall Thickness	Part Number	Price	Part Number	Core Dia. (ID)	Price
--------	----------------	----	----------------	-------------	-------	-------------	----------------	-------

TITAN HOLLOW **HOLLOW MAX**



4.75"	.51"	.66"	.058"	108-9190	\$4.42	108-9155	.48"	\$10.91
4.75"	.63"	.76"	.058"	108-9191	\$4.42			
5.75"	.51"	.66"	.058"	108-9192	\$4.77	108-9157	.48"	\$11.37
5.75"	.63"	.76"	.058"	108-9193	\$4.87			

TITAN SIDE EJECT **SIDE EJECT MAX**



4.75"	.51"	.66"	.058"	108-9194	\$5.63	108-9186	.48"	\$13.35
4.75"	.63"	.76"	.058"	108-9195	\$5.63			
5.75"	.51"	.66"	.058"	108-9196	\$6.14	108-9188	.48"	\$14.11
5.75"	.63"	.76"	.058"	108-9197	\$5.94			

TITAN SPLIT



5.75"	.64"	.88"	.120"	112-5121	\$7.11			
5.75"	.64"	.92"	.120"	112-5123	\$7.41			

TITAN FAIRWAY HD



5.75"	.64"	.80"	.122"	108-9264	\$8.27			
5.75"	.64"	.92"	.122"	108-9265	\$7.92			

TITAN FAIRWAY



4.75"	.64"	.80"	.122"	92-7941	\$3.35			
5.75"	.64"	.80"	.122"	92-7900	\$4.87			
5.75"	.64"	.92"	.120"	104-9877	\$4.31			

CLASSIC



4.75"	.60"	.75"	.065"	62-4600	\$2.18			
5.75"	.60"	.75"	.065"	86-9720	\$2.84			





ProCore® 864/1298

ProCore® 864/1298

ProCore 864/1298

7/8 Mounting Size (cont.)

TITAN® MAX

	Length	Core Dia. (ID)	OD	Wall Thickness	Part Number	Price	Part Number	Core Dia. (ID)	Price
TITAN SOLID ROUND									
	5.50"	-	.75"	-	108-9246	\$7.05			
	5.50"	-	.88"	-	108-9247	\$8.12			
	6.50"	-	.75"	-	108-9248	\$9.49			
	6.50"	-	.88"	-	108-9249	\$9.74			
TITAN SOLID SLICING									
	5.50"	-	.75"	-	108-9242	\$11.72			
	6.50"	-	.75"	-	108-9243	\$13.09			
TITAN CROSS									
	5.50"	-	.88"	-	108-9259	\$12.08			
NEEDLE TINE									
	6.43"	-	5mm	-	100-3620	\$4.01	Requires Needle Tine Head		
	7.38"	-	8mm	-	100-3621	\$4.11	Requires Needle Tine Head		



TITAN® Split™ Tine

For Faster Return To Playability.

- Design splits cores into smaller pieces
- Divided cores dry quicker for faster processing
- Smaller pieces disintegrate and virtually disappear into turf canopy



Toro® TITAN® Tines made in USA.
© 2012 The Toro Company.

Part Number	Mount	Tip Size	Length	Core Dia. (ID)	OD	Wall Thickness	Price
112-5121	7/8"	3/4"	5.75"	.64"	.88"	.120	\$7.00
112-5122	3/4"	3/4"	5.75"	.51"	.88"	.120	\$7.75
112-5123	7/8"	7/8"	5.75"	.64"	.92"	.120	\$7.30

TITAN® tines fit all current and late model Toro® aerators. Standard mount size fits most competitor equipment. Check mounting size to ensure compatibility. Prices subject to change without notice.



ProCore® 440/660/880



The **ProCore 440/660/880** was built for cost-effective aeration during any season. Each model offers performance through the unique Rotalink™ system ensuring proper tine positioning during aeration for consistent and exceptional hole quality. Sizes range from 40" to 80" and can accommodate multiple tine spacing configurations for precise aeration making these models extremely versatile.

TINE HEADS		TINES REQ'D		TURF GUARDS					
Description	Part No.	Qty. 660	Qty. 880	Part No.	Qty. 660	Qty. 880	Part No.	Qty. 660	Qty. 880
Needle Tine Head 660/880	09720	48	64	100-5418	6	-	100-5415	1	-
				100-5419	-	7			
Quad Tine Head, 3/8" Mount	09721	60	80	100-5420	1	5	100-5421	8	4
3 Tine Head, 3/4" Mount	09722	18	24	100-5414	2	5	100-5415	3	-
4 Tine Head, 3/4" Mount	09723	24	32	100-5416	5	1	100-5417	-	4
3 Tine Head, 7/8" Mount	09733	18	24	100-5414	2	5	100-5415	3	-
4 Tine Head, 7/8" Mount	09734	24	32	100-5416	5	1	100-5417	-	4

ProCore 440/660/880

3/8 Mounting Size

TITAN® MAX

Length	Core Dia. (ID)	OD	Wall Thickness	Part Number	Price	Part Number	Core Dia. (ID)	Price
TITAN QUAD						QUAD MAX		
4.50"	.25"	.36"	.052"	108-9104	\$6.34	108-9112	.23"	\$11.62
4.50"	.32"	.46"	.063"	108-9105	\$7.66	108-9114	.28"	\$12.03
4.50"	.41"	.55"	.063"	108-9106	\$8.17	108-9116	.38"	\$12.13
4.50"	.48"	.58"	.063"	108-9293	\$8.07			
5.00"	.25"	.36"	.052"	108-9108	\$6.34	108-9120	.23"	\$11.57
5.00"	.32"	.46"	.063"	108-9109	\$7.66	108-9122	.28"	\$12.03
5.00"	.41"	.55"	.063"	108-9110	\$8.17	108-9124	.38"	\$11.98
5.00"	.48"	.58"	.063"	108-9294	\$8.32			
5.50"	.41"	.55"	.063"	108-9290	\$9.19			



TITAN SOLID ROUND

4.50"	-	.20"	-	108-9230	\$4.31			
4.50"	-	.25"	-	108-9231	\$4.36			
4.50"	-	.30"	-	108-9232	\$4.36			
4.50"	-	.38"	-	108-9233	\$4.42			
5.50"	-	.20"	-	108-9234	\$4.57			
5.50"	-	.25"	-	108-9235	\$4.62			
5.50"	-	.30"	-	108-9236	\$4.62			
5.50"	-	.38"	-	108-9237	\$4.64			



TITAN SOLID SLICING

5.00"	-	.63"	-	108-9238	\$11.17			
-------	---	------	---	----------	---------	--	--	--



TITAN CROSS

4.50"	-	.38"	-	108-9215	\$7.76			
4.50"	-	.50"	-	108-9216	\$8.07	112-1310	-	\$14.36
4.50"	-	.62"	-	108-9217	\$8.37			
5.50"	-	.38"	-	108-9218	\$9.29			
5.50"	-	.50"	-	108-9219	\$9.64	112-1311	-	\$14.67
5.50"	-	.62"	-	108-9220	\$10.00			



ProCore® 440/660/880

ProCore® 440/660/880

ProCore 440/660/880

3/4 Mounting Size **TITAN® MAX**

Length	Core Dia. (ID)	OD	Wall Thickness	Part Number	Price	Part Number	Core Dia. (ID)	Price
--------	----------------	----	----------------	-------------	-------	-------------	----------------	-------

TITAN HOLLOW **HOLLOW MAX**

	4.75"	.28"	.46"	.058"	108-9128	\$4.31	108-9139	.28"	\$10.20
	4.75"	.41"	.56"	.058"	108-9129	\$4.47	108-9141	.38"	\$10.40
	4.75"	.53"	.66"	.058"	108-9130	\$4.31	108-9143	.48"	\$10.20
	5.75"	.28"	.46"	.058"	108-9132	\$4.67	108-9145	.28"	\$10.76
	5.75"	.41"	.56"	.058"	108-9133	\$4.57	108-9147	.38"	\$10.76
	5.75"	.53"	.66"	.058"	108-9134	\$4.57	108-9149	.48"	\$11.57

TITAN HOLLOW EXT. TAPER **HOLLOW EXT. TAPER MAX**

	5.75"	.53"	.66"	.058"	114-0551	\$4.52	114-0553	.47"	\$10.76
---	-------	------	------	-------	----------	--------	----------	------	---------

TITAN SIDE EJECT **SIDE EJECT MAX**

	4.75"	.28"	.46"	.055"	108-9159	\$5.53	108-9170	.28"	\$13.04
	4.75"	.41"	.56"	.058"	108-9160	\$5.63	108-9172	.38"	\$13.04
	4.75"	.53"	.66"	.058"	108-9161	\$5.63	108-9174	.48"	\$13.04
	5.75"	.28"	.46"	.055"	108-9163	\$5.73	108-9176	.28"	\$13.45
	5.75"	.41"	.56"	.058"	108-9164	\$5.73	108-9178	.38"	\$13.55
	5.75"	.53"	.66"	.058"	108-9165	\$5.94	108-9180	.48"	\$13.60

TITAN SIDE EJECT EXT. TAPER **SIDE EJECT EXT. TAPER MAX**

	5.75"	.53"	.66"	.058"	114-0555	\$5.73	114-0557	.47"	\$13.55
---	-------	------	------	-------	----------	--------	----------	------	---------

TITAN SPLIT

	5.75"	.51"	.88"	.120"	112-5122	\$7.87			
---	-------	------	------	-------	----------	--------	--	--	--

TITAN FAIRWAY HD

	5.75"	.51"	.70"	.122"	108-9260	\$6.80			
	5.75"	.51"	.80"	.122"	108-9261	\$7.21			

TITAN FAIRWAY

	5.75"	.51"	.77"	.120"	104-9876	\$4.16			
	5.75"	.51"	.88"	.120"	104-9875	\$4.16			

ProCore 440/660/880

3/4 Mounting Size (cont.) **TITAN® MAX**

Length	Core Dia. (ID)	OD	Wall Thickness	Part Number	Price	Part Number	Core Dia. (ID)	Price
--------	----------------	----	----------------	-------------	-------	-------------	----------------	-------

CLASSIC

	4.75"	.30"	.44"	.035"	59-3690	\$1.57		
	4.75"	.40"	.50"	.049"	66-9140	\$1.57		
	4.75"	.50"	.63"	.049"	59-3670	\$1.80		
	5.75"	.51"	.63"	.058"	104-0984	\$2.94		

TITAN SOLID ROUND

	4.50"	-	.25"	-	108-9198	\$4.77		
	4.50"	-	.30"	-	108-9199	\$4.77		
	4.50"	-	.35"	-	108-9200	\$4.87		
	4.50"	-	.40"	-	108-9201	\$4.77		
	4.50"	-	.50"	-	108-9202	\$4.77		
	4.50"	-	.60"	-	108-9203	\$4.77		
	5.50"	-	.25"	-	108-9204	\$4.97		
	5.50"	-	.30"	-	108-9205	\$4.87		
	5.50"	-	.35"	-	108-9206	\$4.82		
	5.50"	-	.40"	-	108-9207	\$4.87		
	5.50"	-	.50"	-	108-9208	\$4.87		
	5.50"	-	.60"	-	108-9209	\$4.97		
	5.50"	-	.75"	-	108-9244	\$4.77		

TITAN SOLID SLICING

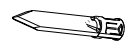
	4.50"	-	.75"	-	108-9239	\$10.61		
	5.50"	-	.75"	-	108-9240	\$10.91		



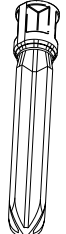





TITAN CROSS **CROSS MAX**

	4.50"	-	.50"	-	108-9221	\$8.63	112-1312	-	\$15.48
	4.50"	-	.63"	-	108-9222	\$8.93			
	4.50"	-	.75"	-	108-9223	\$9.24			
	5.50"	-	.50"	-	108-9224	\$8.88	112-1313	-	\$15.48
	5.50"	-	.63"	-	108-9225	\$9.19			
	5.50"	-	.75"	-	108-9226	\$9.54			

ProCore 440/660/880

7/8 Mounting Size

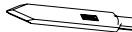
TITAN® MAX

	Length	Core Dia. (ID)	OD	Wall Thickness	Part Number	Price	Part Number	Core Dia. (ID)	Price	
TITAN HOLLOW							HOLLOW MAX			
	4.75"	.51"	.66"	.058"	108-9190	\$4.42	108-9155	.48"	\$10.91	
	4.75"	.63"	.76"	.058"	108-9191	\$4.42				
	5.75"	.51"	.66"	.058"	108-9192	\$4.77	108-9157	.48"	\$11.37	
	5.75"	.63"	.76"	.058"	108-9193	\$4.87				
TITAN SIDE EJECT							SIDE EJECT MAX			
	4.75"	.51"	.66"	.058"	108-9194	\$5.63	108-9186	.48"	\$13.35	
	4.75"	.63"	.76"	.058"	108-9195	\$5.63				
	5.75"	.51"	.66"	.058"	108-9196	\$6.14	108-9188	.48"	\$14.11	
	5.75"	.63"	.76"	.058"	108-9197	\$5.94				
TITAN SPLIT										
	5.75"	.64"	.88"	.120"	112-5121	\$7.11				
	5.75"	.64"	.92"	.120"	112-5123	\$7.41				
TITAN FAIRWAY HD										
	5.75"	.64"	.80"	.122"	108-9264	\$8.27				
	5.75"	.64"	.92"	.122"	108-9265	\$7.92				
TITAN FAIRWAY										
	4.75"	.64"	.80"	.122"	92-7941	\$3.35				
	5.75"	.64"	.80"	.122"	92-7900	\$4.87				
	5.75"	.64"	.92"	.120"	104-9877	\$4.31				
CLASSIC										
	4.75"	.60"	.75"	.065"	62-4600	\$2.18				
	5.75"	.60"	.75"	.065"	86-9720	\$2.84				
TITAN SOLID ROUND										
	5.50"	-	.75"	-	108-9246	\$7.05				
	5.50"	-	.88"	-	108-9247	\$8.12				
TITAN SOLID SLICING										
	5.50"	-	.75"	-	108-9242	\$11.72				
TITAN CROSS										
	5.50"	-	.88"	-	108-9259	\$12.08				
NEEDLE TINE										
	6.43"	-	5mm	-	100-3620	\$4.01	Requires Needle Tine Head			
	7.38"	-	8mm	-	100-3621	\$4.11	Requires Needle Tine Head			



Turf Aerator

686/687



The **686** and **687 Turf Aerators** give excellent depth and performance and follow ground contours, vertically and horizontally, like no other available.

ProCore 686/687

	Part Number	Price	Qty. Req'd
SPOON-OPEN			
	108-9296 (1/2")	\$4.67	96
SPOON-CLOSED			
	108-9297 (1/2")	\$4.87	96
	108-9299 (3/4")	\$4.57	96

Greens

AERATOR



If there was a Hall of Fame for aerators, the Toro® **Greens Aerator** would definitely be inducted. This powerful and efficient greens aerator was produced for 17 solid years following its introduction in 1986. Although it's officially in retirement, there are many of them around the world still aerating greens as well as they did brand new.



Tine Heads and Turf Guards

TINE HEADS		TINES REQ'D	TURF GUARDS	
Description	Part No.		Part No.	Qty. Req'd
Needle Tine Head	94-3421	12		
3/8" Tine Head	94-3420	12	72-4660 (RH)	1
			72-4680 (Ctr)	1
3/4" Tine Head	59-2500	12	72-4640 (LH)	1
7/8" Tine Head	62-4610	12		

Greens Aerator

3/8 Mounting Size

TITAN® MAX

	Length	Core Dia. (ID)	OD	Wall Thickness	Part Number	Price	Part Number	Core Dia. (ID)	Price
TITAN QUAD							QUAD MAX		
	4.50"	.25"	.36"	.052"	108-9104	\$6.34	108-9112	.23"	\$11.62
	4.50"	.32"	.46"	.063"	108-9105	\$7.66	108-9114	.28"	\$12.03
	4.50"	.41"	.55"	.063"	108-9106	\$8.17	108-9116	.38"	\$12.13
	4.50"	.48"	.58"	.063"	108-9293	\$8.07			
TITAN SOLID ROUND									
	4.50"	-	.20"	-	108-9230	\$4.31			
	4.50"	-	.25"	-	108-9231	\$4.36			
	4.50"	-	.30"	-	108-9232	\$4.36			
	4.50"	-	.38"	-	108-9233	\$4.42			
TITAN HOLLOW							HOLLOW MAX		
	4.50"	-	.38"	-	108-9215	\$7.76			
	4.50"	-	.50"	-	108-9216	\$8.07	112-1310	-	\$14.36
	4.50"	-	.62"	-	108-9217	\$8.37			

Greens Aerator

Greens Aerator





GENUINE TORO PARTS

Greens Aerator

Greens Aerator

3/4 Mounting Size

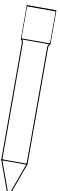



TITAN® MAX

	Length	Core Dia. (ID)	OD	Wall Thickness	Part Number	Price	Part Number	Core Dia. (ID)	Price
TITAN HOLLOW							HOLLOW MAX		
	4.75"	.28"	.46"	.058"	108-9128	\$4.31	108-9139	.28"	\$10.20
	4.75"	.41"	.56"	.058"	108-9129	\$4.47	108-9141	.38"	\$10.40
	4.75"	.53"	.66"	.058"	108-9130	\$4.31	108-9143	.48"	\$10.20
TITAN SIDE EJECT							SIDE EJECT MAX		
	4.75"	.28"	.46"	.055"	108-9159	\$5.53	108-9170	.28"	\$13.04
	4.75"	.41"	.56"	.058"	108-9160	\$5.63	108-9172	.38"	\$13.04
	4.75"	.53"	.66"	.058"	108-9161	\$5.63	108-9174	.48"	\$13.04
CLASSIC									
	4.75"	.30"	.44"	.035"	59-3690	\$1.57			
	4.75"	.40"	.50"	.049"	66-9140	\$1.57			
	4.75"	.50"	.63"	.049"	59-3670	\$1.80			
TITAN SOLID ROUND							SOLID ROUND MAX		
	4.50"	-	.25"	-	108-9198	\$4.77			
	4.50"	-	.30"	-	108-9199	\$4.77			
	4.50"	-	.35"	-	108-9200	\$4.87			
	4.50"	-	.40"	-	108-9201	\$4.77			
	4.50"	-	.50"	-	108-9202	\$4.77			
	4.50"	-	.60"	-	108-9203	\$4.77			
TITAN SOLID SLICING									
	4.50"	-	.75"	-	108-9239	\$10.61			
TITAN CROSS							CROSS MAX		
	4.50"	-	.50"	-	108-9221	\$8.63	112-1312	-	\$15.48
	4.50"	-	.63"	-	108-9222	\$8.93			
	4.50"	-	.75"	-	108-9223	\$9.24			

Greens Aerator

7/8 Mounting Size

TITAN® MAX

	Length	Core Dia. (ID)	OD	Wall Thickness	Part Number	Price	Part Number	Core Dia. (ID)	Price
TITAN HOLLOW							HOLLOW MAX		
	4.75"	.51"	.66"	.058"	108-9190	\$4.42	108-9155	.48"	\$10.91
	4.75"	.63"	.76"	.058"	108-9191	\$4.42			
TITAN SIDE EJECT							SIDE EJECT MAX		
	4.75"	.51"	.66"	.058"	108-9194	\$5.63	108-9186	.48"	\$13.35
	4.75"	.63"	.76"	.058"	108-9195	\$5.63			
CLASSIC									
	4.75"	.60"	.75"	.065"	62-4600	\$2.18			
TITAN FAIRWAY									
	4.75"	.64"	.80"	.122"	92-7941	\$3.35			
NEEDLE TINE									
	6.43"	-	5mm	-	100-3620	\$4.01			Requires Needle Tine Head

Fairway

AERATOR

The **Fairway Aerator** is a legend. Based on the name, one might assume its sole purpose is fairways. However, this tough aerator performs exceptionally well on sports fields and other turf. Although production ended in 1996, there is still many Fairway Aerators working today that we've added their tine offering back into the catalog.









Tine Heads and Turf Guards

TINE HEADS		TINES REQ'D	TURF GUARDS	
Description	Part No.		Part No.	Qty. Req'd
6-Tine, 3/4" Block		36	70-9430 70-9440	3
Outer	95-3103			
Bridging	95-3104			
Inner	95-3105			
6-Tine, 7/8" Block		12		
Outer	70-9380			
Bridging	70-9390			
Inner	70-9400			

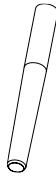
Fairway Aerator

3/4 Mounting Size

TITAN® MAX

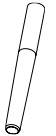
	Length	Core Dia. (ID)	OD	Wall Thickness	Part Number	Price	Part Number	Core Dia. (ID)	Price
TITAN HOLLOW							HOLLOW MAX		
	4.75"	.28"	.46"	.058"	108-9128	\$4.31	108-9139	.28"	\$10.20
	4.75"	.41"	.56"	.058"	108-9129	\$4.47	108-9141	.38"	\$10.40
	4.75"	.53"	.66"	.058"	108-9130	\$4.31	108-9143	.48"	\$10.20
	5.75"	.28"	.46"	.058"	108-9132	\$4.67	108-9145	.28"	\$10.76
	5.75"	.41"	.56"	.058"	108-9133	\$4.57	108-9147	.38"	\$10.76
	5.75"	.53"	.66"	.058"	108-9134	\$4.57	108-9149	.48"	\$11.57
TITAN HOLLOW EXT. TAPER							HOLLOW EXT. TAPER MAX		
	5.75"	.53"	.66"	.058"	114-0551	\$4.52	114-0553	.47"	\$10.76
TITAN SIDE EJECT							SIDE EJECT MAX		
	4.75"	.28"	.46"	.055"	108-9159	\$5.53	108-9170	.28"	\$13.04
	4.75"	.41"	.56"	.058"	108-9160	\$5.63	108-9172	.38"	\$13.04
	4.75"	.53"	.66"	.058"	108-9161	\$5.63	108-9174	.48"	\$13.04
	5.75"	.28"	.46"	.055"	108-9163	\$5.73	108-9176	.28"	\$13.45
	5.75"	.41"	.56"	.058"	108-9164	\$5.73	108-9178	.38"	\$13.55
	5.75"	.53"	.66"	.058"	108-9165	\$5.94	108-9180	.48"	\$13.60
TITAN SIDE EJECT EXT. TAPER							SIDE EJECT EXT. TAPER MAX		
	5.75"	.53"	.66"	.058"	114-0555	\$5.73	114-0557	.47"	\$13.55
TITAN SPLIT									
	5.75"	.64"	.88"	.120"	112-5121	\$7.11			
TITAN FAIRWAY HD									
	5.75"	.51"	.70"	.122"	108-9260	\$6.80			
	5.75"	.51"	.80"	.122"	108-9261	\$7.21			
TITAN FAIRWAY									
	5.75"	.51"	.77"	.120"	104-9876	\$4.16			
	5.75"	.51"	.88"	.120"	104-9875	\$4.16			
CLASSIC									
	4.75"	.30"	.44"	.035"	59-3690	\$1.57			
	4.75"	.40"	.50"	.049"	66-9140	\$1.57			
	4.75"	.50"	.63"	.049"	59-3670	\$1.80			
	5.75"	.51"	.63"	.058"	104-0984	\$2.94			

Fairway Aerator

Fairway Aerator

GENUINE TORO PARTS

Fairway Aerator

Fairway Aerator

3/4 Mounting Size (cont.)

TITAN® MAX

Length	Core Dia. (ID)	OD	Wall Thickness	Part Number	Price	Part Number	Core Dia. (ID)	Price
TITAN SOLID ROUND								
4.50"	-	.25"	-	108-9198	\$4.77			
4.50"	-	.30"	-	108-9199	\$4.77			
4.50"	-	.35"	-	108-9200	\$4.87			
4.50"	-	.40"	-	108-9201	\$4.77			
4.50"	-	.50"	-	108-9202	\$4.77			
4.50"	-	.60"	-	108-9203	\$4.77			
5.50"	-	.25"	-	108-9204	\$4.97			
5.50"	-	.30"	-	108-9205	\$4.87			
5.50"	-	.35"	-	108-9206	\$4.82			
5.50"	-	.40"	-	108-9207	\$4.87			
5.50"	-	.50"	-	108-9208	\$4.87			
5.50"	-	.60"	-	108-9209	\$4.97			
5.50"	-	.75"	-	108-9244	\$4.77			
4.50"	-	.75"	-	108-9239	\$10.61			
5.50"	-	.75"	-	108-9240	\$10.91			

TITAN CROSS

HOLLOW MAX

4.50"	-	.50"	-	108-9221	\$8.63	112-1312	-	\$15.48
4.50"	-	.63"	-	108-9222	\$8.93			
4.50"	-	.75"	-	108-9223	\$9.24			
5.50"	-	.50"	-	108-9224	\$8.88	112-1313	-	\$15.48
5.50"	-	.63"	-	108-9225	\$9.19			
5.50"	-	.75"	-	108-9226	\$9.54			

7/8" Mounting Size

TITAN® MAX

TITAN HOLLOW

HOLLOW MAX

4.75"	.51"	.66"	.058"	108-9190	\$4.42	108-9155	.48"	\$10.91
4.75"	.63"	.76"	.058"	108-9191	\$4.42			
5.75"	.51"	.66"	.058"	108-9192	\$4.77	108-9157	.48"	\$11.37
5.75"	.63"	.76"	.058"	108-9193	\$4.87			

Fairway Aerator

7/8 Mounting Size (cont.)

TITAN® MAX

Length	Core Dia. (ID)	OD	Wall Thickness	Part Number	Price	Part Number	Core Dia. (ID)	Price
TITAN SIDE EJECT								
4.75"	.51"	.66"	.058"	108-9194	\$5.63	108-9186	.48"	\$13.35
4.75"	.63"	.76"	.058"	108-9195	\$5.63			
5.75"	.51"	.66"	.058"	108-9196	\$6.14	108-9188	.48"	\$14.11
5.75"	.63"	.76"	.058"	108-9197	\$5.94			
TITAN SPLIT								
5.75"	.64"	.88"	.120"	112-5121	\$7.11			
5.75"	.64"	.92"	.120"	112-5123	\$7.41			
TITAN FAIRWAY HD								
5.75"	.64"	.80"	.122"	108-9264	\$8.27			
5.75"	.64"	.92"	.122"	108-9265	\$7.92			
TITAN FAIRWAY								
4.75"	.64"	.80"	.122"	92-7941	\$3.35			
5.75"	.64"	.80"	.122"	92-7900	\$4.87			
5.75"	.64"	.92"	.120"	104-9877	\$4.31			
CLASSIC								
4.75"	.60"	.75"	.065"	62-4600	\$2.18			
5.75"	.60"	.75"	.065"	86-9720	\$2.84			
TITAN SOLID ROUND								
5.50"	-	.75"	-	108-9246	\$7.05			
5.50"	-	.88"	-	108-9247	\$8.12			
TITAN SOLID SLICING								
5.50"	-	.75"	-	108-9242	\$11.72			
TITAN CROSS								
5.50"	-	.88"	-	108-9259	\$12.08			

ProCore® SR SERIES



The **ProCore SR Series** provide working widths of 48" – 75" (122 – 190 cm), working depths up to 16" (40.6 cm) and hole spacing from 2.5" – 6" (6.3 – 15.2 cm). From lightweight, precision machines for more sensitive turf to robust heavy-duty machines to break up the soil on the most compacted surfaces, the ProCore SR Series deep tine aerators are the ultimate choice for performance and quality.

TINE HEADS		QTY. REQ'D
Description	PartNo.	
SR54-S/SR70-S, 5/16" or 12mm Mount	SGH08704-03	SR54-S: 18 SR72-S: 24
SR54/SR70, 5/16" or 12mm Mount	SG407054-03	SR54: 12 or 18 SR70: 16 or 24
SR48/SR72, 12mm or 18mm Mount	SG404010-03	SR48: 8 to 16 SR72: 12 to 24
SR75HD, 12mm or 18 mm Mount	SG32111-03	SR75HD: 12

FEATURES & BENEFITS

- Heavy-duty design
- Hydraulic remote depth adjustment from the tractor
- Superior punching power
- Multiple coring and solid tines
- Easy hook-up and operation
- Simplified maintenance

GENUINE TORO PARTS

ProCore® SR Series

ProCore SR48

Head SG404010-03

This head comes installed on the ProCore® SR48. See adapter head kit section for additional tine configuration options.

Mount	Length	Core Dia. (ID)	OD	Part Number	Price	Adapter Sleeve	Replacement Tube	Price
SOLID TINES								
	.3125"	8.50"	-	.3125"	SGS07313*	\$2.79	SGA08313	
	.3125"	10.00"	-	.3125"	SGS08313*	\$2.99	SGA08313	
	.375"	9.00"	-	.375"	SGS08375*	\$3.96	SGA12375	
	.375"	10.75"	-	.375"	SGS10374*	\$3.96	SGA12375	
	.375"	12.25"	-	.375"	SGS10375*	\$4.16	SGA12375	
	12mm	8.00"	-	12mm	SGS08500	\$3.96		
	12mm	10.75"	-	12mm	SGS10504	\$6.04		
	12mm	12.25"	-	12mm	SGS10500	\$6.34		
	12mm	14.25"	-	12mm	SGS12500	\$6.90		
	12mm	16.25"	-	12mm	SGS14500	\$7.36		
	18mm	12.25"	-	18mm	SGS10750	\$9.24		
	18mm	12.50"	-	.875"	SGS10875	\$17.81		
	18mm	14.00"	-	.875"	SGS12875	\$19.08		
	18mm	14.25"	-	18mm	SGS12750	\$10.20		
	18mm	16.00"	-	.875"	SGS14875	\$20.71		
	18mm	16.25"	-	18mm	SGS14750	\$11.57		
CORING TINES								
	12mm	7.00"	.52"	.69"	SGC07625	\$14.62		SGT07625 \$8.78
	12mm	7.00"	.56"	.81"	SGC07750	\$17.51		SGT07750 \$11.17
	12mm	10.00"	.56"	.75"	SGC10755	\$22.84		SGT10750 \$16.49
	12mm	10.00"	.56"	.81"	SGC10813H	\$23.90		SGT10813H \$17.51
	18mm	8.00"	.94"	1.31"	SGC08125	\$32.94		SGT08125 \$27.10
	18mm	8.00"	.74"	1.06"	SGC08100H	\$28.17		SGT08100H \$22.44
	18mm	10.00"	.56"	.75"	SGC10750	\$22.84		SGT10750 \$16.49
	18mm	10.00"	.74"	1.06"	SGC10100H	\$30.30		SGT10100H \$23.90
	18mm	10.00"	.76"	1.00"	SGC10100S	\$29.93		SGT10100S \$22.84
	18mm	12.00"	.94"	1.31"	SGC12125	\$38.16		SGT12125 \$30.81

*Adapter Sleeve is required.

ProCore SR48 (cont.)

Adapter Kits

Mount	Length	Core Dia. (ID)	OD	Part Number	Price	Adapter Sleeve	Replacement Tube	Price
Adapter Head Kit 117-7190								
SOLID TINES								
.3125"	8.50"	-	.3125"	SGS07313	\$2.79			
.3125"	10.00"	-	.3125"	SGS08313	\$2.99			

Adapter Head Kit 117-7191

SOLID TINES								
12mm	8.00"	-	12mm	SGS08500	\$3.96			
12mm	12.25"	-	12mm	SGS10500	\$6.34			
12mm	14.25"	-	12mm	SGS12500	\$6.90			
12mm	16.25"	-	12mm	SGS14500	\$7.36			
CORING TINES								
12mm	7.00"	.52"	.69"	SGC07624	\$14.62		SGT07625	\$8.78
12mm	7.00"	.56"	.81"	SGC07754	\$17.51		SGT07750	\$11.17
12mm	10.00"	.56"	.75"	SGC10754	\$22.84		SGT10750	\$16.49

ProCore SR54

Head SG407054-03

This head comes installed on the ProCore® SR54. See adapter head kit section for additional tine configuration options.

Mount	Length	Core Dia. (ID)	OD	Part Number	Price	Adapter Sleeve	Replacement Tube	Price
SOLID TINES								
.3125"	8.50"	-	.3125"	SGS07313	\$2.79			
.3125"	10.00"	-	.3125"	SGS08313	\$2.99			
.375"	9.00"	-	.375"	SGS08375*	\$3.96	SGA10375		
.375"	10.75"	-	.375"	SGS10374*	\$3.96	SGA10375		
12mm	8.00"	-	12mm	SGS08500	\$3.96			
12mm	10.75"	-	12mm	SGS10504	\$6.04			
CORING TINES								
.375"	5.50"	.38"	.50"	SGC05550*	\$7.71	SGA10375		
12mm	7.00"	.52"	.69"	SGC07624	\$14.62		SGT07625	\$8.78
12mm	7.00"	.56"	.81"	SGC07754	\$17.51		SGT07750	\$11.17
12mm	10.00"	.56"	.75"	SGC10754	\$22.84		SGT10750	\$16.49

Adapter Head Kit 117-7193

SOLID TINES								
.3125"	8.50"	-	.3125"	SGS07313	\$2.79			
.3125"	10.00"	-	.3125"	SGS08313	\$2.99			
.375"	9.00"	-	.375"	SGS08375*	\$3.96	SGA10375		
.375"	10.75"	-	.375"	SGS10374*	\$3.96	SGA10375		
.375"	12.25"	-	.375"	SGS10375*	\$4.16	SGA10375		
CORING TINES								
.375"	5.50"	.38"	.50"	SGC05550	\$7.71		SGT05550	\$5.02

*Adapter Sleeve is required.

ProCore SR54-S

Head SGH08704-03

This head comes installed on the ProCore® SR54-S. See adapter head kit section for additional tine configuration options.

Mount	Length	Core Dia. (ID)	OD	Part Number	Price	Adapter Sleeve	Replacement Tube	Price
SOLID TINES								
.3125"	8.50"	-	.3125"	SGS07313	\$2.79			
.3125"	10.00"	-	.3125"	SGS08313	\$2.99			
12mm	8.00"	-	12mm	SGS08500	\$3.96			
12mm	10.75"	-	12mm	SGS10504	\$6.04			
CORING TINES								
12mm	7.00"	.52"	.69"	SGC07624	\$14.62		SGT07625	\$8.78
12mm	7.00"	.56"	.81"	SGC07754	\$17.51		SGT07750	\$11.17
12mm	10.00"	.56"	.75"	SGC10754	\$22.84		SGT10750	\$16.49

Adapter Head Kit 117-7194

SOLID TINES								
18mm	12.25"	-	18mm	SGS10750	\$9.24			

Adapter Head Kit 117-7195

SOLID TINES								
.3125"	8.50"	-	.3125"	SGS07313	\$2.79			
.3125"	10.00"	-	.3125"	SGS08313	\$2.99			
12mm	8.00"	-	12mm	SGS08500	\$3.96			
12mm	10.75"	-	12mm	SGS10504	\$6.04			
CORING TINES								
12mm	7.00"	.52"	.69"	SGC07624	\$14.62		SGT07625	\$8.78
12mm	7.00"	.56"	.81"	SGC07754	\$17.51		SGT07750	\$11.17
12mm	10.00"	.56"	.75"	SGC10754	\$22.84		SGT10750	\$16.49

ProCore SR54-S (cont.)

Adapter Kits (cont.)

Mount	Length	Core Dia. (ID)	OD	Part Number	Price	Adapter Sleeve	Replacement Tube	Price
Adapter Head Kit 117-7196								
SOLID TINES								
.3125"	8.50"	-	.3125"	SGS07313	\$2.79			
.3125"	10.00"	-	.3125"	SGS08313	\$2.99			
.375"	9.00"	-	.375"	SGS08375	\$3.96			
.375"	10.75"	-	.375"	SGS10374	\$3.96			
CORING TINES								
.375"	5.50"	.38"	.50"	SGC05550	\$7.71		SGT05550	\$5.02

Adapter Head Kit 117-7199

SOLID TINES								
.375"	9.00"	-	.375"	SGS08375	\$3.96			
.375"	10.75"	-	.375"	SGS10374	\$3.96			
CORING TINES								
.375"	5.50"	.38"	.50"	SGC05550	\$7.71		SGT05550	\$5.02

ProCore SR70

Head SG407054-03

This head comes installed on the ProCore® SR70. See adapter head kit section for additional tine configuration options.

Mount	Length	Core Dia. (ID)	OD	Part Number	Price	Adapter Sleeve	Replacement Tube	Price
SOLID TINES								
.3125"	8.50"	-	.3125"	SGS07313	\$2.79			
.3125"	10.00"	-	.3125"	SGS08313	\$2.99			
.375"	9.00"	-	.375"	SGS08375*	\$3.96	SGA10375		
.375"	10.75"	-	.375"	SGS10374*	\$3.96	SGA10375		
12mm	8.00"	-	12mm	SGS08500	\$3.96			
12mm	10.75"	-	12mm	SGS10504	\$6.04			
CORING TINES								
.375"	5.50"	.38"	.50"	SGC05550*	\$7.71	SGA10375	SGT05550	\$5.02
12mm	7.00"	.52"	.69"	SGC07624	\$14.62		SGT07625	\$8.78
12mm	7.00"	.56"	.81"	SGC07754	\$17.51		SGT07750	\$11.17
12mm	10.00"	.56"	.75"	SGC10754	\$22.84		SGT10750	\$16.49

Adapter Head Kit 117-7193

Mount	Length	Core Dia. (ID)	OD	Part Number	Price	Adapter Sleeve	Replacement Tube	Price
SOLID TINES								
.3125"	8.50"	-	.3125"	SGS07313	\$2.79			
.3125"	10.00"	-	.3125"	SGS08313	\$2.99			
.375"	9.00"	-	.375"	SGS08375	\$3.96			
.375"	10.75"	-	.375"	SGS10374	\$3.96			
.375"	12.25"	-	.375"	SGS10375	\$4.16			
CORING TINES								
.375"	5.50"	-	.50"	SGC05550*	\$7.71			

*Adapter Sleeve is required.

ProCore SR70-S

Head SGH08704-03

This head comes installed on the ProCore® SR70-S. See adapter head kit section for additional tine configuration options.

Mount	Length	Core Dia. (ID)	OD	Part Number	Price	Adapter Sleeve	Replacement Tube	Price
SOLID TINES								
.3125"	8.50"	-	.3125"	SGS07313	\$2.79			
.3125"	10.00"	-	.3125"	SGS08313	\$2.99			
12mm	8.00"	-	12mm	SGS08500	\$3.96			
12mm	10.75"	-	12mm	SGS10504	\$6.04			
CORING TINES								
12mm	7.00"	.52"	.69"	SGC07624	\$14.62		SGT07625	\$8.78
12mm	7.00"	.56"	.81"	SGC07754	\$17.51		SGT07750	\$11.17
12mm	10.00"	.56"	.75"	SGC10754	\$22.84		SGT10750	\$16.49

Adapter Head Kit 117-7194

SOLID TINES								
18mm	12.25"	-	18mm	SGS10750	\$9.24			

Adapter Head Kit 117-7195

SOLID TINES								
.3125"	8.50"	-	.3125"	SGS07313	\$2.79			
.3125"	10.00"	-	.3125"	SGS08313	\$2.99			
12mm	8.00"	-	12mm	SGS08500	\$3.96			
12mm	10.75"	-	12mm	SGS10504	\$6.04			
CORING TINES								
12mm	7.00"	.52"	.69"	SGC07624	\$14.62		SGT07625	\$8.78
12mm	7.00"	.56"	.81"	SGC07754	\$17.51		SGT07750	\$11.17
12mm	10.00"	.56"	.75"	SGC10754	\$22.84		SGT10750	\$16.49

ProCore® SR70-S Adapter Kits continued on the next page. >

ProCore SR70-S (cont.)

Adapter Kits (cont.)

Mount	Length	Core Dia. (ID)	OD	Part Number	Price	Adapter Sleeve	Replacement Tube	Price
Adapter Head Kit 117-7196								
SOLID TINES								
.3125"	8.50"	-	.3125"	SGS07313	\$2.79			
.3125"	10.00"	-	.3125"	SGS08313	\$2.99			
.375"	9.00"	-	.375"	SGS08375	\$3.96			
.375"	10.75"	-	.375"	SGS10374	\$3.96			
CORING TINES								
.375"	5.50"	.38"	.50"	SGC05550	\$7.71		SGT05550	\$5.02
Adapter Head Kit 117-7199								
SOLID TINES								
.375"	9.00"	-	.375"	SGS08375	\$3.96			
.375"	10.75"	-	.375"	SGS10374	\$3.96			
CORING TINES								
.375"	5.50"	.38"	.50"	SGC05550	\$7.71		SGT05550	\$5.02

ProCore SR72

Head SG404010-03

This head comes installed on the ProCore® SR72. See adapter head kit section for additional tine configuration options.

Mount	Length	Core Dia. (ID)	OD	Part Number	Price	Adapter Sleeve	Replacement Tube	Price
SOLID TINES								
.3125"	8.50"	-	.3125"	SGS07313*	\$2.79	SGA08313		
.3125"	10.00"	-	.3125"	SGS08313*	\$2.99	SGA08313		
.375"	9.00"	-	.375"	SGS08375*	\$3.96	SGA12375		
.375"	10.75"	-	.375"	SGS10374*	\$3.96	SGA12375		
.375"	12.25"	-	.375"	SGS10375*	\$4.16	SGA12375		
12mm	8.00"	-	12mm	SGS08500	\$3.96			
12mm	10.75"	-	12mm	SGS10504	\$6.04			
12mm	12.25"	-	12mm	SGS10500	\$6.34			
12mm	14.25"	-	12mm	SGS12500	\$6.90			
12mm	16.25"	-	12mm	SGS14500	\$7.36			
18mm	12.25"	-	18mm	SGS10750	\$9.24			
18mm	12.50"	-	18mm	SGS10875	\$17.81			
18mm	14.00"	-	18mm	SGS12875	\$19.08			
18mm	14.25"	-	18mm	SGS12750	\$10.20			
18mm	16.00"	-	18mm	SGS14875	\$20.71			
18mm	16.25"	-	18mm	SGS14750	\$11.57			
CORING TINES								
12mm Long	7.00"	.52"	.69"	SGC07625	\$14.62		SGT07625	\$8.78
12mm Long	7.00"	.56"	.81"	SGC07750	\$17.51		SGT07750	\$11.17
12mm Long	10.00"	.56"	.75"	SGC10755	\$22.84		SGT10750	\$16.49
12mm Long	10.00"	.56"	.81"	SGC10813H	\$23.90		SGT10813H	\$17.51
18mm Long	8.00"	.94"	1.31"	SGC08125	\$32.94		SGT08125	\$27.10
18mm Long	8.00"	.74"	1.06"	SGC08100H	\$28.17		SGT08100H	\$22.44
18mm Long	10.00"	.56"	.75"	SGC10750	\$22.84		SGT10750	\$16.49
18mm Long	10.00"	.74"	1.06"	SGC10100H	\$30.30		SGT10100H	\$23.90
18mm Long	10.00"	.76"	1.00"	SGC10100S	\$29.23		SGT10100S	\$22.84
18mm Long	12.00"	.94"	1.31"	SGC12125	\$38.16		SGT12125	\$30.81

*Adapter Sleeve is required.

ProCore® SR72 Adapter Kits continued on the next page. >

ProCore SR72 (cont.)

Adapter Kits

Mount	Length	Core Dia. (ID)	OD	Part Number	Price	Adapter Sleeve	Replacement Tube	Price
Adapter Head Kit 117-7190								
SOLID TINES								
.3125"	8.50"	-	.3125"	SGS07313	\$2.79			
.3125"	10.00"	-	.3125"	SGS08313	\$2.99			
Adapter Head Kit 117-7191								
SOLID TINES								
12mm	8.00"	-	12mm	SGS08500	\$3.96			
12mm	12.25"	-	12mm	SGS10500	\$6.34			
12mm	14.25"	-	12mm	SGS12500	\$6.90			
12mm	16.25"	-	12mm	SGS14500	\$7.36			
CORING TINES								
12mm	7.00"	.52"	.69"	SGC07624	\$14.62		SGT07625	\$8.78
12mm	7.00"	.56"	.81"	SGC07754	\$17.51		SGT07750	\$11.17
12mm	10.00"	.56"	.75"	SGC10754	\$22.84		SGT10750	\$16.49

ProCore SR75

Head SG322111-03

This head comes installed on the ProCore® SR75. See adapter head kit section for additional tine configuration options.

Mount	Length	Core Dia. (ID)	OD	Part Number	Price	Adapter Sleeve	Replacement Tube	Price
SOLID TINES								
18mm	12.25"	-	18mm	SGS10750*	\$9.24	SG715802		
18mm	12.50"	-	18mm	SGS10875*	\$17.81	SG715802		
18mm	14.00"	-	18mm	SGS12875*	\$19.08	SG715802		
18mm	14.25"	-	18mm	SGS12750*	\$10.20	SG715802		
18mm	16.00"	-	18mm	SGS14875*	\$20.71	SG715802		
18mm	16.25"	-	18mm	SGS14750*	\$11.57	SG715802		
.875"	12.50"	-	18mm	SGS10876	\$17.81			
.875"	14.00"	-	18mm	SGS12876	\$19.08			
.875"	15.75"	-	18mm	SGS14876	\$20.71			
.875"	17.88"	-	1.00"	SGS16100	\$22.84			
CORING TINES								
18mm Long	8.00"	.94"	1.31"	SGC08125*	\$32.94	SG715802	SGT08125	\$27.10
18mm Long	8.00"	.74"	1.06"	SGC08100H*	\$28.17	SG715802	SGT08100H	\$22.44
18mm Long	10.00"	.56"	.75"	SGC10750*	\$22.84	SG715802	SGT10750	\$16.49
18mm Long	10.00"	.74"	1.06"	SGC10100H*	\$30.30	SG715802	SGT10100H	\$23.90
18mm Long	10.00"	.76"	1.00"	SGC10100S*	\$29.23	SG715802	SGT10100S	\$22.84
18mm Long	12.00"	.94"	1.31"	SGC12125*	\$38.16	SG715802	SGT12125	\$30.81
.875"	8.00"	.94"	1.31"	SGC08123	\$32.94		SGT08125	\$27.10
.875"	12.00"	.94"	1.31"	SGC12123	\$38.16		SGT12125	\$30.81

*Adapter Sleeve is required.

ProCore® SR75 Adapter Kits continued on the next page. >

ProCore SR75 (cont.)

Adapter Kits

Mount	Length	Core Dia. (ID)	OD	Part Number	Price	Adapter Sleeve	Replacement Tube	Price
Adapter Head Kit 117-7198								
SOLID TINES								
12mm	8.00"	-	12mm	SGS08500	\$3.96			
12mm	10.75"	-	12mm	SGS10504	\$6.04			
12mm	12.25"	-	12mm	SGS10500	\$6.34			
12mm	14.25"	-	12mm	SGS12500	\$6.90			
12mm	16.25"	-	12mm	SGS14500	\$7.36			
18mm	12.25"	-	18mm	SGS10750	\$9.24			
18mm	12.50"	-	.875"	SGS10875	\$17.81			
18mm	14.00"	-	.875"	SGS12875	\$19.08			
18mm	14.25"	-	18mm	SGS12750	\$10.20			
18mm	16.00"	-	.875"	SGS14875	\$20.71			
18mm	16.25"	-	18mm	SGS14750	\$11.57			

CORING TINES

12mm Long	7.00"	.52"	.69"	SGC07625	\$14.62		SGT07625	\$8.78
12mm Long	7.00"	.56"	.81"	SGC07750	\$17.51		SGT07750	\$11.17
12mm Long	10.00"	.56"	.81"	SGC10813H	\$23.90		SGT10813H	\$17.51
12mm Long	10.00"	.56"	.75"	SGC10755	\$22.84		SGT10750	\$16.49
18mm Long	8.00"	.74"	1.06"	SGC08100H	\$28.17		SGT08100H	\$22.44
18mm Long	8.00"	.94"	1.31"	SGC08125	\$32.94		SGT08125	\$27.10
18mm Long	10.00"	.56"	.75"	SGC10750	\$22.84		SGT07625	\$8.78
18mm Long	10.00"	.76"	1.00"	SGC10100S	\$29.23		SGT10100S	\$22.84
18mm Long	10.00"	.74"	1.06"	SGC10100H	\$30.30		SGT10100H	\$23.90
18mm Long	12.00"	.94"	1.31"	SGC12125	\$38.16		SGT12125	\$30.81

TITAN® TINES for Competitive Models

3/8 Mounting Size

TITAN® MAX

COMPETITIVE MODEL

Length	Core Dia. (ID)	OD	Wall Thickness	Part Number	Price	Part Number	Core Dia. (ID)	Price	Ryan® GA 24/30/60	John Deere®
TITAN QUAD					QUAD MAX					
4.50"	.25"	.36"	.052"	108-9104	\$6.34	108-9112	.23"	\$11.62	X	X
4.50"	.32"	.46"	.063"	108-9105	\$7.66	108-9114	.28"	\$12.03	X	X
4.50"	.41"	.55"	.063"	108-9106	\$8.17	108-9116	.38"	\$12.13	X	X
4.50"	.48"	.58"	.063"	108-9293	\$8.07				X	X
5.00"	.25"	.36"	.052"	108-9108	\$6.34	108-9120	.23"	\$11.57	X	X
5.00"	.32"	.46"	.063"	108-9109	\$7.66	108-9122	.28"	\$12.03	X	X
5.00"	.41"	.55"	.063"	108-9110	\$8.17	108-9124	.38"	\$11.98	X	X
5.00"	.48"	.58"	.063"	108-9294	\$8.32				X	X
TITAN SOLID ROUND										
4.50"	-	.20"	-	108-9230	\$4.31				X	X
4.50"	-	.25"	-	108-9231	\$4.36				X	X
4.50"	-	.30"	-	108-9232	\$4.36				X	X
4.50"	-	.38"	-	108-9233	\$4.42				X	X
5.50"	-	.20"	-	108-9234	\$4.57				X	X
5.50"	-	.25"	-	108-9235	\$4.62				X	X
5.50"	-	.30"	-	108-9236	\$4.62				X	X
5.50"	-	.38"	-	108-9237	\$4.64				X	X
TITAN SOLID SLICING										
5.00"	-	.63"	-	108-9238	\$11.17				X	X
TITAN CROSS					CROSS MAX					
4.50"	-	.38"	-	108-9215	\$7.76				X	X
4.50"	-	.50"	-	108-9216	\$8.07	112-1310	-	\$14.36	X	X
4.50"	-	.62"	-	108-9217	\$8.37				X	X
5.50"	-	.38"	-	108-9218	\$9.29				X*	X
5.50"	-	.50"	-	108-9219	\$9.64	112-1311	-	\$14.67	X*	X
5.50"	-	.62"	-	108-9220	\$10.00				X*	X

*Only available on GA 30/60 models

TITAN® Conversion Sleeves

EASILY CONVERTS TITAN TINES TO 1/2" AND 5/8" MOUNT

Toro conversion sleeves allow the complete selection of Toro tines to fit on most competitive equipment. The conversion sleeve slides onto a 3/8" mount Toro tine to create a 1/2" mount or 5/8" mount.

Part Number	Description	Mount	Price
112-1300	Sleeve	1/2"	\$1.05
112-1301	Sleeve	5/8"	\$1.05

Competitive Models

Competitive Models

Competitive Models

Competitive Models

TITAN® TINES for Competitive Models						TITAN® MAX			COMPETITIVE MODEL	
1/2 Mounting Size										
Length	Core Dia. (ID)	OD	Wall Thickness	Part Number	Price	Part Number	Core Dia. (ID)	Price	Ryan® GA 24/30/60	John Deere®
TITAN QUAD						QUAD MAX				
4.50"	.32"	.46"	.063"	112-1316	\$6.24	112-1322	.28"	\$10.91	X	
TITAN SOLID ROUND										
4.50"	-	.50"	-	112-1347	\$5.13				X	
5.50"	-	.25"	-	112-1329	\$5.38				X	
5.00"	-	.38"	-	112-1330	\$5.08				X	
TITAN SOLID CROSS										
4.50"	-	.50"	-	112-5104	\$7.46				X	
5.50"	-	.50"	-	112-5105	\$9.03				X*	
TITAN SOLID SLICING										
5.00"	-	.63"	-	112-5102	\$10.56				X	

TITAN® TINES for Competitive Models						TITAN® MAX			COMPETITIVE MODEL	
5/8 Mounting Size										
Length	Core Dia. (ID)	OD	Wall Thickness	Part Number	Price	Part Number	Core Dia. (ID)	Price	Ryan® GA 24/30/60	John Deere®
TITAN HOLLOW						HOLLOW MAX				
4.50"	.43"	.56"	.058"	112-1306	\$4.26	112-1307	.38"	\$11.11	X	
TITAN SIDE EJECT						SIDE EJECT MAX				
4.50"	.43"	.56"	.058"	112-1303	\$5.08	112-1304	.38"	\$12.43	X	
TITAN SOLID ROUND										
4.50"	-	.63"	-	112-1348	\$4.72				X	
TITAN SOLID CROSS										
4.50"	-	.50"	-	112-5106	\$8.58				X	
5.50"	-	.50"	-	112-5107	\$8.83				X*	
TITAN SOLID SLICING										
5.00"	-	.63"	-	112-5103	\$10.56				X	

*Only available on GA 30/60 models

TITAN® TINES for Competitive Models						TITAN® MAX			COMPETITIVE MODEL	
3/4 Mounting Size										
Length	Core Dia. (ID)	OD	Wall Thickness	Part Number	Price	Part Number	Core Dia. (ID)	Price	Ryan® GA 24/30/60	John Deere®
TITAN HOLLOW						HOLLOW MAX				
4.75"	.28"	.46"	.058"	108-9128	\$4.31	108-9139	.28"	\$10.20	X	X
4.75"	.41"	.56"	.058"	108-9129	\$4.47	108-9141	.38"	\$10.40	X	X
4.75"	.53"	.66"	.058"	108-9130	\$4.31	108-9143	.48"	\$10.20	X	X
5.75"	.28"	.46"	.058"	108-9132	\$4.67	108-9145	.28"	\$10.76	X*	X
5.75"	.41"	.56"	.058"	108-9133	\$4.57	108-9147	.38"	\$10.76	X*	X
5.75"	.53"	.66"	.058"	108-9134	\$4.57	108-9149	.48"	\$11.57	X*	X
TITAN HOLLOW EXT. TAPER										
5.75"	.53"	.66"	.058"	114-0551	\$4.52	114-0553	.47"	\$10.76	X*	X
TITAN SIDE EJECT						SIDE EJECT MAX				
4.75"	.28"	.46"	.055"	108-9159	\$5.53	108-9170	.28"	\$13.04	X	
4.75"	.41"	.56"	.058"	108-9160	\$5.63	108-9172	.38"	\$13.04	X	
4.75"	.53"	.66"	.058"	108-9161	\$5.63	108-9174	.48"	\$13.04	X	
5.75"	.28"	.46"	.055"	108-9163	\$5.73	108-9176	.28"	\$13.45		X
5.75"	.41"	.56"	.058"	108-9164	\$5.73	108-9178	.38"	\$13.55		X
5.75"	.53"	.66"	.058"	108-9165	\$5.94	108-9180	.48"	\$13.60		X
TITAN SIDE EJECT EXT. TAPER						EXT. TAPER MAX				
5.75"	.53"	.66"	.058"	114-0555	\$5.73	114-0557	.47"	\$13.55	X	
TITAN FAIRWAY HD										
5.75"	.51"	.70"	.122"	108-9260	\$6.80				X*	X
5.75"	.51"	.80"	.122"	108-9261	\$7.21				X*	X
TITAN FAIRWAY										
5.75"	.51"	.77"	.120"	104-9876	\$4.16					X
5.75"	.51"	.88"	.120"	104-9875	\$4.16					X
CLASSIC										
4.75"	.30"	.44"	.035"	59-3690	\$1.57				X	X
4.75"	.40"	.50"	.049"	66-9140	\$1.57				X	X
4.75"	.50"	.63"	.049"	59-3670	\$1.80				X	X
5.75"	.51"	.63"	.058"	104-0984	\$2.94				X*	X

*Only available on GA 30/60 models

Competitive Models

GENUINE TORO PARTS

Competitive Models

Competitive Models

Competitive Models

TITAN® TINES for Competitive Models						TITAN® MAX			COMPETITIVE MODEL	
3/4 Mounting Size										
Length	Core Dia. (ID)	OD	Wall Thickness	Part Number	Price	Part Number	Core Dia. (ID)	Price	Ryan® GA 24/30/60	John Deere®
TITAN SOLID ROUND										
4.50"	-	.25"	-	108-9198	\$4.77				X	X
4.50"	-	.30"	-	108-9199	\$4.77				X	X
4.50"	-	.35"	-	108-9200	\$4.87				X	X
4.50"	-	.40"	-	108-9201	\$4.77				X	X
4.50"	-	.50"	-	108-9202	\$4.77				X	X
4.50"	-	.60"	-	108-9203	\$4.77				X	X
5.50"	-	.25"	-	108-9204	\$4.97				X*	X
5.50"	-	.30"	-	108-9205	\$4.87				X*	X
5.50"	-	.35"	-	108-9206	\$4.82				X*	X
5.50"	-	.40"	-	108-9207	\$4.87				X*	X
5.50"	-	.50"	-	108-9208	\$4.87				X*	X
5.50"	-	.60"	-	108-9209	\$4.97				X*	X
5.50"	-	.75"	-	108-9244	\$4.77				X*	X
TITAN SOLID SLICING						CROSS MAX				
4.50"	-	.75"	-	108-9239	\$10.61				X	X
5.50"	-	.75"	-	108-9240	\$10.91				X*	X
TITAN CROSS						CROSS MAX				
4.50"	-	.50"	-	108-9221	\$8.63	112-1312	-	\$15.48	X	X
4.50"	-	.63"	-	108-9222	\$8.93				X	X
4.50"	-	.75"	-	108-9223	\$9.24				X	X
5.50"	-	.50"	-	108-9224	\$8.88	112-1313	-	\$15.48	X*	X
5.50"	-	.63"	-	108-9225	\$9.19				X*	X
5.50"	-	.75"	-	108-9226	\$9.54				X*	X

*Only available on GA 30/60 models

TITAN® TINES for Competitive Models						TITAN® MAX			COMPETITIVE MODEL	
7/8 Mounting Size										
Length	Core Dia. (ID)	OD	Wall Thickness	Part Number	Price	Part Number	Core Dia. (ID)	Price	Ryan® GA 24/30/60	John Deere®
TITAN HOLLOW						HOLLOW MAX				
4.75"	.51"	.66"	.058"	108-9190	\$4.42	108-9155	.48"	\$10.91	X*	X
4.75"	.63"	.76"	.058"	108-9191	\$4.42				X*	X
5.75"	.51"	.66"	.058"	108-9192	\$4.77	108-9157	.48"	\$11.37	X*	X
5.75"	.63"	.76"	.058"	108-9193	\$4.87				X*	X
TITAN SIDE EJECT						SIDE EJECT MAX				
4.75"	.51"	.66"	.058"	108-9194	\$5.63	108-9186	.48"	\$13.35	X*	X
4.75"	.63"	.76"	.058"	108-9195	\$5.63				X*	X
5.75"	.51"	.66"	.058"	108-9196	\$6.14	108-9188	.48"	\$14.11	X*	X
5.75"	.63"	.76"	.058"	108-9197	\$5.94				X*	X
TITAN FAIRWAY HD										
5.75"	.64"	.80"	.122"	108-9264	\$8.27				X*	X
5.75"	.64"	.92"	.122"	108-9265	\$7.92				X*	X
TITAN FAIRWAY										
4.75"	.64"	.80"	.122"	92-7941	\$3.35				X	X
5.75"	.64"	.80"	.122"	92-7900	\$4.87				X*	X
5.75"	.64"	.92"	.120"	104-9877	\$4.31				X*	X
CLASSIC										
4.75"	.60"	.75"	.065"	62-4600	\$2.18				X*	X
5.75"	.60"	.75"	.065"	86-9720	\$2.84				X*	X
TITAN SOLID ROUND										
5.50"	-	.75"	-	108-9246	\$7.05				X*	X
5.50"	-	.88"	-	108-9247	\$8.12				X*	X
TITAN SOLID SLICING										
5.50"	-	.75"	-	108-9242	\$11.72				X*	X
TITAN CROSS										
5.50"	-	.88"	-	108-9259	\$12.08				X*	X

*Only available on GA 30/60 models

myTurf™ Fleet Management

Tired of tracking equipment hours? Not always sure when maintenance is due? Let myTurf™ help.

myTurf is an easy to use online system that lets you track hours and maintenance for all your turf equipment—think of it as your electronic “White Board.”

Combined with our Wireless Hour Meter system, your equipment will report its hours automatically to myTurf. The system alerts you when labor is due, and tracks parts and maintenance costs.

Choose from three myTurf programs:

myTurf Fleet – Simplified Equipment Management-Free

- Track your entire fleet online
- Instant access to the latest Toro manuals and information
- Order parts online anytime, anywhere from your distributor

myTurf PM – Longer Equipment Life. Increased Productivity

- All the benefits of myTurf Fleet
- Ensure Preventive Maintenance is done and tracked (Does not include repairs - To track repairs see myTurf TCO)
- Automated Maintenance Alerts
- Create Work Orders
- 90 Day Free Trial

myTurf TCO – Total Cost of Ownership and Maintenance

- All the benefits of myTurf Fleet and myTurf PM
- Ensure all Maintenance is done – PM and Repairs
- Track your own parts inventory
- Easier record keeping and equipment replacement justification
- 90 Day Free Trial

For more information and to enroll visit:

myturf.com

Or, call us at:

1-888-222-8676



BaseStation
115-9542

Wireless Hour Meter
115-4754

Wireless Hour Meters automatically communicate equipment hours to myTurf



To See What's New WWW.TORO.COM



Toro® has a comprehensive website that offers a wealth of information about Toro products and services.

Here is a sampling of what you can do at Toro.com:

- Find replacement parts for your Toro with our Master Parts Viewer
- Locate dealers and distributors worldwide
- Download equipment manuals
- Learn about Toro financing programs
- Get company information and download the latest Toro news



Count on it.



Count on it.

Products depicted in this catalog are for demonstration purposes only. Actual products offered for sale may vary.

©2012 The Toro Company.
All rights reserved.
Printed in the U.S.A.



Ryan® and Jacobsen® are registered trademarks of TEXTRON Turf Care and Specialty Products, Racine, WI 53403

John Deere® is a registered trademark of John Deere Co. Research Triangle Park, NC 27709

Form No. 12-111-T