

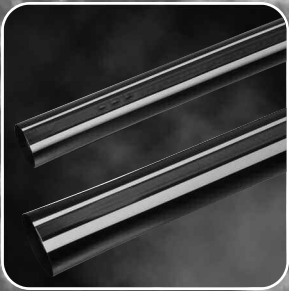

2015 Price List

Effective November 19, 2014



Aqua-Traxx® FC
with the PBX Advantage



BlueLine®
Premium Dripline

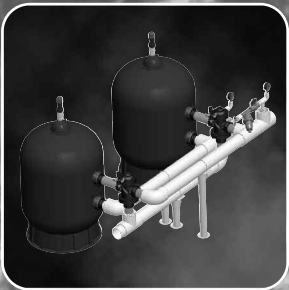

Aqua-Clear
Automated Sand Filters

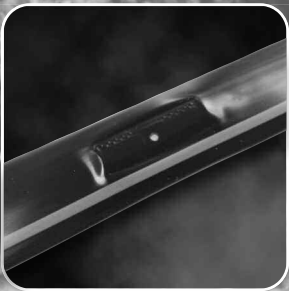

Neptune
Flat Emitter Dripline



Micro Sprinkler PC



Micro-Irrigation

This price list is effective November 19, 2014 and replaces all previous price lists. All list prices are US\$ FOB shipping point and subject to change without notice.

TORO

Count on it.

Toro Micro-Irrigation 2015 Price List



Contact Information

The Toro Company
Micro-Irrigation Business
1588 N. Marshall Avenue
El Cajon, CA 92020-1523, USA

Phone Numbers:

+1 (800) 333-8125

+1 (619) 562-2950

Fax Numbers:

+1 (800) 892-1822

+1 (619) 258-9973

Websites:

toro.com

driptips.toro.com

©2014 The Toro Company

We reserve the right to improve our products and make changes in the specifications and designs without notice and without incurring obligation. Products depicted in this brochure are for demonstration purposes only. Actual products offered for sale may vary in design and features.

Micro-Irrigation Highlights for 2015



Aqua-Traxx® FC with the PBX Advantage

1~4

- Aqua-Traxx Flow Control (FC) drip tape is the latest advancement in the evolution of precision drip irrigation.
- More uniform output for any terrain
- Flexibility to increase and decrease flow without sacrificing uniformity
- Emitter spacing from 6–24 inches with no cost increase



Neptune

18~19

Flat Emitter Dripline

- Ideal for use in demanding applications where thicker walled products can provide greater durability, such as subsurface drip irrigation (SDI) or semi-permanent crop applications
- Discrete emitter is highly resistant to plugging
- Strong and flexible for easy installation and removal.
- Blue Stripe® of Quality - install with blue stripe up to ensure proper outlet placement

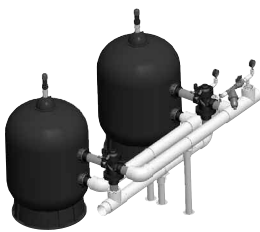

Aqua-Clear

81~82

Automated Sand Filters

- Designed for drip irrigation systems operating up to 75 psi and 400 gpm
- One-piece, fiberglass reinforced tank with a UV-resistant coating
- Ideal for small- to medium-sized fields
- Automatic or manual valves enable easy backflushing



Micro Sprinkler PC

62

- Designed for orchards, vineyards, and nurseries
- Wide diameter of throw: 16 - 31 feet
- Pressure-compensation from 20 - 60 psi
- Color coded nozzles: 9 - 40 GPH



Table of Contents



	Product Category	Page No.
Aqua-Traxx® Drip Tape		
 Aqua-Traxx® FC Drip Tape	.I	.1~4
Aqua-Traxx® with the PBX Advantage	.I	.5~9
Aqua-Traxx® with the PBX Advantage - Short Reels	.I	.10
Aqua-Traxx® Flow Rate Table	-	.12
Aqua-Traxx® Reorder Chart	-	.13
Fusion System Splicer for Aqua-Traxx®	.VIII	.14
Drip Tape Fittings		
Pro-Loc™ Tape Fittings	.VIII	.15~16
Tape Fitting Accessories	.VIII	.17
Ring-Loc™ Tape Fittings	.VIII	.17
Tape Riser Assembly	.VIII	.18
Flush Valves	.VI	.18
Neptune		
 Non-Pressure Compensating Flat Emitter Dripline	.XIII	.20~21
Dripline		
BlueLine™ PC Dripline	.II	.23~24
BlueLine™ Classic Dripline	.II	.25~26
BlueLine™ PC Clipperline	.II	.27
BlueLine™ Classic Clipperline	.II	.27
Drip In® PC Dripline	.II	.28~29
Drip In® PC Short Coils	.II	.30
Drip In® PC (Metric)	.II	.31
Drip In® Classic Dripline	.II	.32~33
Drip In® Classic (Metric)	.II	.34
Drip In® PC & Classic Dripline with Rootguard	.II	.35~37
Drip In® PC Clipperline	.II	.38
Drip In® Soaker Classic Dripline	.II	.38
Hose		
Blue Stripe® Micro-Distribution Hose	.III	.40
Blue Stripe® Oval Hose	.III	.40
Layflat Hose	.III	.41
IPS Flexible PVC Tubing	.III	.41
Oval Hose & Layflat Fittings	.VIII	.42
Blue Stripe® Round Hose	.III	.43~44
Colored Striped Round Hose	.III	.44
Colored Round Hose	.III	.45
Outside Diameter (OD) Controlled Round Hose	.III	.46
Blue Stripe® Clipperhose™	.III	.47
Blue Stripe® Pre-Punched Hose	.III	.47
Hose & Dripline Fittings		
Pro-Loc™ Hose & Dripline Fittings	.VIII	.48~49
Barbed Hose Fittings & Accessories	.VIII	.50~51
Oval Hose & Layflat Fittings	.VIII	.52
Oval Hose & Layflat Clamps	.VIII	.53
Take-Off Fittings for PVC	.VIII	.53
Loc-Eze® Hose Fittings	.VIII	.53~54
Clip Rings for Clipperline™ & Clipperhose™	.VIII	.54
H-Curls	.VIII	.54
Accessories	.VIII	.55
Check & Flush Valves	.VI	.55
Emission Devices & Accessories		
N.G.E® AL (Anti-Drain) New Generation Emitter	.IV	.57
N.G.E® SF (Self Flushing) New Generation Emitter	.IV	.57
Turbo-SC® Plus Emitter	.IV	.57
Turbo-Plus™ II Emitter	.IV	.57
Turbo-Key® Emitter	.IV	.58
E-2® Emitter	.IV	.58
Nursery Pot Spray Stakes	.IV	.58



Table of Contents

	Product Category	Page No.
Emission Devices & Accessories		
Black Spider Single Outlet Device Assemblies	.IV	.59
White Spider Single Outlet Device Assemblies	.IV	.59
Black Spider Multi-Outlet Device Assemblies	.IV	.59
White Spider Multi-Outlet Device Assemblies	.IV	.60
Black Spider Fittings	.IV	.60
Black Spider & Pot Spray Stake Leader Tube	.III	.60
Black Spider & Pot Spray Stake Distribution Hose	.III	.61
Punches & Tools	.VIII	.61
Foggers	.IV	.62
Snap-Jet® II	.V	.62
Micro-Sprinkler	.V	.63-64
Adapters, Bases & Stakes	.VIII	.66
Leader Tube with Take-Off	.VIII	.67
Leader Tube	.III	.67
Miscellaneous Accessories	.VIII	.67
Chemical Injection		
Mazzei® Injectors® Polypropylene	.VIII	.69
Mazzei® Injectors® PVDF	.VIII	.69
Mazzei® Injectors® Accessories	.VIII	.70
Valves		
Electric Valves	.VI	.72
Manual Valves	.VI	.72
Anti-Contamination Valves	.VI	.72
Hydraulic Valves	.VI	.72
Pressure Regulating Valves	.VI	.73
Plastic Y-Pattern Bermad Valves	.VI	.74
Plastic Angle-Pattern Bermad Valves	.VI	.75
Metal Bermad Valves	.VI	.76
Air Release & Vacuum Relief Valves	.VI	.77
Pressure Regulators	.VI	.77
Valve Accessories	.VI	.78
Controllers		
KwikDial Series Controller	.VII	.80
Rain Dial® Series Controllers	.VII	.80
Total Control® Series Controllers	.VII	.80
MC-E® Series Controllers	.VII	.80
PC Control™	.VII	.81
IBOC® Plus Controllers - Battery or Solar Operated	.VII	.81
Junior™ DC	.VII	.81
Controller Accessories	.VII	.81
Filtration		
Fiberglass Sand Media Filters (Automatic Systems)	.IX	.83
Fiberglass Sand Media Filters (Single Filters & Components)	.IX	.84
Manual Disc Filters	.IX	.85-87
Manual Screen Filters	.IX	.87
Promotional Items		
Product Literature (English)	.XI	.89
Product Literature (Spanish)	.XI	.90
Educational Literature (English)	.XI	.91
Educational Literature (Spanish)	.XI	.91
Promotional Items	.XI	.91
Sales Policy		
Terms & Conditions		.92
Sales Warranty		.93



For Replacement Parts, please refer to the
Micro-Irrigation Replacement Parts Price List
available online at:

toro.com



To order, call Toro Micro-Irrigation
El Cajon, Ca: +1 (800) 333-8125 or +1 (619) 562-2950
Sanford, Fl: +1 (800) 806-6582 or +1 (407) 321-2901
List Prices are US\$. FOB Shipping Point. Effective November 19, 2014 (ALT002)

TORO. Count on it.

AquaFlow

Drip Irrigation Design Software

Save time. Improve designs. Make better decisions.

- Create designs online or download
- Dashboard automatically formats to screen or font size
- Compare different designs
- Color-coded uniformity display
- Unlimited slopes
- Multiple pipe types and sizes
- English or Spanish languages
- Single or multiple block reports
- Flushing for both laterals and submains
- Standard English or Metric units

**With AquaFlow,
YOU are in control.**



Toro's **FREE** state-of-the-art drip irrigation design software is available at toro.com or driptips.toro.com

Click Here to create designs online or download AquaFlow



Tape

Drip Tape



Aqua-Traxx FC (Category I)

Flow Control Drip Tape

STOCKED ITEMS. PRODUCT GENERALLY AVAILABLE IN STOCK

Flow rate expressed in gpm per 100 feet (Q-100) @ 10 psi (0,7 Bar).



Part Number	Wall Thickness		Reel Length		Reel Weight		Spacing in cm	Available Flow Rates		Reel Dia. Height	List Price Per Reel
	mil	mm	Ft.	M	Lbs.	Kilos		gpm Q-100 feet	liters / hour-meter		
5/8" Diameter (16mm)											
EAFC5060667-1000	6 mil	0.15	10,000	3,048	64	29	6" 15	0.67	4.99	20" 11"	495.00
EAFC5060690-1000	6 mil	0.15	10,000	3,048	64	29	6" 15	0.90	6.66	20" 11"	495.00
EAFC5060850-1000	6 mil	0.15	10,000	3,048	64	29	8" 20	0.50	3.74	20" 11"	495.00
EAFC5060867-1000	6 mil	0.15	10,000	3,048	64	29	8" 20	0.67	4.99	20" 11"	495.00
EAFC5061234-1000	6 mil	0.15	10,000	3,048	64	29	12" 30	0.34	2.50	20" 11"	495.00
EAFC5061245-1000	6 mil	0.15	10,000	3,048	64	29	12" 30	0.45	3.33	20" 11"	495.00
7/8" Diameter (22mm)											
EAFC5080667-750	8 mil	0.20	7,500	2,286	66	30	6" 15	0.67	4.99	20" 11"	455.00
EAFC5080690-750	8 mil	0.20	7,500	2,286	66	30	6" 15	0.90	6.66	20" 11"	455.00
EAFC5080850-750	8 mil	0.20	7,500	2,286	66	30	8" 20	0.50	3.74	20" 11"	455.00
EAFC5080867-750	8 mil	0.20	7,500	2,286	66	30	8" 20	0.67	4.99	20" 11"	455.00
EAFC5081234-750	8 mil	0.20	7,500	2,286	66	30	12" 30	0.34	2.50	20" 11"	455.00
EAFC5081245-750	8 mil	0.20	7,500	2,286	66	30	12" 30	0.45	3.33	20" 11"	455.00
EAFC7100667-440	10 mil	0.25	4,400	1,341	71	32	6" 15	0.67	4.99	20" 11"	430.00
EAFC7100690-440	10 mil	0.25	4,400	1,341	71	32	6" 15	0.90	6.66	20" 11"	430.00
EAFC7100850-440	10 mil	0.25	4,400	1,341	71	32	8" 20	0.50	3.74	20" 11"	430.00
EAFC7100867-440	10 mil	0.25	4,400	1,341	71	32	8" 20	0.67	4.99	20" 11"	430.00
EAFC7101234-440	10 mil	0.25	4,400	1,341	71	32	12" 30	0.34	2.50	20" 11"	430.00
EAFC7101245-440	10 mil	0.25	4,400	1,341	71	32	12" 30	0.45	3.33	20" 11"	430.00

XXX or XX denotes the flow rate in gpm per 100 feet (Q-100) @ 10 psi. Substitute XXX or XX with the flow rates available for each spacing, indicated in the gpm Q-100 column. Example: EAFC5060867-1000 (Aqua-Traxx FC 5/8"; 6 mil; 8" spacing; 0.67 gpm Q-100; 10,000 Ft. Coil

The Advantages of Flow Control

AQUA-TRAXX® FC

Toro Aqua-Traxx FC gives you uniform output regardless of elevation changes. So now you can adjust the amount of water you give your plants on hilly terrain, and they'll all receive the same amount through our uniform delivery system.

RESULT: More uniform plants and higher yields even in hilly terrain that might otherwise be impractical to farm.

AQUA-TRAXX® FC

Toro Aqua-Traxx FC puts you in control of watering decisions. You control how much water your plants receive by increasing or decreasing the operating pressure — without sacrificing uniformity.

RESULT: More uniform delivery of water and fertilizer to the roots of your plants with the flexibility to control application rates.

Advantage #1

MORE UNIFORM OUTPUT FOR ANY TERRAIN

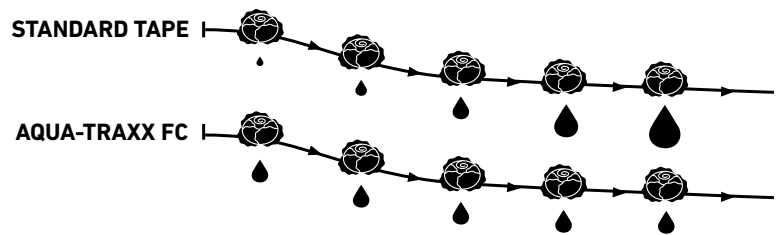

Advantage #2

THE ABILITY TO CONTROL THE FLOW

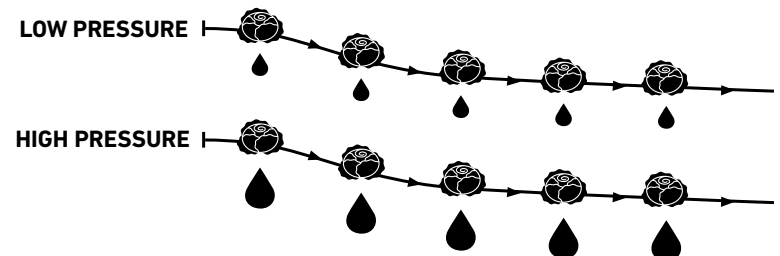

Drip Tape



Aqua-Traxx FC (Category I) Flow Control Drip Tape

◇ **MADE TO ORDER.** US\$ 7,500.00 minimum order value will apply. Toro Micro-Irrigation Customer Service will confirm by Fax that the order has been accepted and the estimated date of delivery.
Flow rate expressed in gpm per 100 feet (Q-100) @ 10 psi (0.7 Bar).



Part Number	Wall Thickness		Reel Length		Reel Weight		Spacing		Available Flow Rates		Reel		List Price Per Reel
	mil	mm	Ft.	M	Lbs.	Kilos	in	cm	gpm Q-100 feet	liters / hour-meter	Dia.	Height	
5/8" Diameter (16mm)													
◇ EAFC5061625-1000	6 mil	0.15	10,000	3,048	64	29	16"	40	0.25	1.86	20"	11"	495.00
◇ EAFC5061634-1000	6 mil	0.15	10,000	3,048	64	29	16"	40	0.34	2.50	20"	11"	495.00
◇ EAFC5061822-1000	6 mil	0.15	10,000	3,048	64	29	18"	45	0.22	1.66	20"	11"	495.00
◇ EAFC5061830-1000	6 mil	0.15	10,000	3,048	64	29	18"	45	0.30	2.22	20"	11"	495.00
◇ EAFC5062417-1000	6 mil	0.15	10,000	3,048	64	29	24"	60	0.17	1.25	20"	11"	495.00
◇ EAFC5062422-1000	6 mil	0.15	10,000	3,048	64	29	24"	60	0.22	1.67	20"	11"	495.00
◇ EAFC5081625-750	8 mil	0.20	7,500	2,286	66	30	16"	40	0.25	1.86	20"	11"	455.00
◇ EAFC5081634-750	8 mil	0.20	7,500	2,286	66	30	16"	40	0.34	2.5	20"	11"	455.00
◇ EAFC5081822-750	8 mil	0.20	7,500	2,286	66	30	18"	45	0.22	1.66	20"	11"	455.00
◇ EAFC5081830-750	8 mil	0.20	7,500	2,286	66	30	18"	45	0.30	2.22	20"	11"	455.00
◇ EAFC5082417-750	8 mil	0.20	7,500	2,286	66	30	24"	60	0.17	1.25	20"	11"	455.00
◇ EAFC5082422-750	8 mil	0.20	7,500	2,286	66	30	24"	60	0.22	1.67	20"	11"	455.00
◇ EAFC5100667-600	10 mil	0.25	6,000	1,829	63	29	6"	15	0.67	4.99	20"	11"	465.00
◇ EAFC5100690-600	10 mil	0.25	6,000	1,829	63	29	6"	15	0.90	6.66	20"	11"	465.00
◇ EAFC5100850-600	10 mil	0.25	6,000	1,829	63	29	8"	20	0.50	3.74	20"	11"	465.00
◇ EAFC5100867-600	10 mil	0.25	6,000	1,829	63	29	8"	20	0.67	4.99	20"	11"	465.00
◇ EAFC5101234-600	10 mil	0.25	6,000	1,829	63	29	12"	30	0.34	2.50	20"	11"	465.00
◇ EAFC5101245-600	10 mil	0.25	6,000	1,829	63	29	12"	30	0.45	3.33	20"	11"	465.00
◇ EAFC5101625-600	10 mil	0.25	6,000	1,829	63	29	16"	40	0.25	1.86	20"	11"	465.00
◇ EAFC5101634-600	10 mil	0.25	6,000	1,829	63	29	16"	40	0.34	2.50	20"	11"	465.00
◇ EAFC5101822-600	10 mil	0.25	6,000	1,829	63	29	18"	45	0.22	1.66	20"	11"	465.00
◇ EAFC5101830-600	10 mil	0.25	6,000	1,829	63	29	18"	45	0.30	2.22	20"	11"	465.00
◇ EAFC5102417-600	10 mil	0.25	6,000	1,829	63	29	24"	60	0.17	1.25	20"	11"	465.00
◇ EAFC5102422-600	10 mil	0.25	6,000	1,829	63	29	24"	60	0.22	1.67	20"	11"	465.00
◇ EAFC5120667-510	12 mil	0.30	5,100	1,554	63	29	6"	15	0.67	4.99	20"	11"	450.00
◇ EAFC5120690-510	12 mil	0.30	5,100	1,554	63	29	6"	15	0.90	6.66	20"	11"	450.00
◇ EAFC5120850-510	12 mil	0.30	5,100	1,554	63	29	8"	20	0.50	3.74	20"	11"	450.00
◇ EAFC5120867-510	12 mil	0.30	5,100	1,554	63	29	8"	20	0.67	4.99	20"	11"	450.00
◇ EAFC5121234-510	12 mil	0.30	5,100	1,554	63	29	12"	30	0.34	2.50	20"	11"	450.00
◇ EAFC5121245-510	12 mil	0.30	5,100	1,554	63	29	12"	30	0.45	3.33	20"	11"	450.00
◇ EAFC5121625-510	12 mil	0.30	5,100	1,554	63	29	16"	40	0.25	1.86	20"	11"	450.00
◇ EAFC5121634-510	12 mil	0.30	5,100	1,554	63	29	16"	40	0.34	2.50	20"	11"	450.00
◇ EAFC5121822-510	12 mil	0.30	5,100	1,554	63	29	18"	45	0.22	1.66	20"	11"	450.00
◇ EAFC5121830-510	12 mil	0.30	5,100	1,554	63	29	18"	45	0.30	2.22	20"	11"	450.00
◇ EAFC5122417-510	12 mil	0.30	5,100	1,554	63	29	24"	60	0.17	1.25	20"	11"	450.00
◇ EAFC5122422-510	12 mil	0.30	5,100	1,554	63	29	24"	60	0.22	1.67	20"	11"	450.00
◇ EAFC5150667-400	15 mil	0.38	4,000	1,220	63	29	6"	15	0.67	4.99	20"	11"	435.00
◇ EAFC5150690-400	15 mil	0.38	4,000	1,220	63	29	6"	15	0.90	6.66	20"	11"	435.00
◇ EAFC5150850-400	15 mil	0.38	4,000	1,220	63	29	8"	20	0.50	3.74	20"	11"	435.00
◇ EAFC5150867-400	15 mil	0.38	4,000	1,220	63	29	8"	20	0.67	4.99	20"	11"	435.00
◇ EAFC5151234-400	15 mil	0.38	4,000	1,220	63	29	12"	30	0.34	2.50	20"	11"	435.00
◇ EAFC5151245-400	15 mil	0.38	4,000	1,220	63	29	12"	30	0.45	3.33	20"	11"	435.00
◇ EAFC5151625-400	15 mil	0.38	4,000	1,220	63	29	16"	40	0.25	1.86	20"	11"	435.00
◇ EAFC5151634-400	15 mil	0.38	4,000	1,220	63	29	16"	40	0.34	2.50	20"	11"	435.00
◇ EAFC5151822-400	15 mil	0.38	4,000	1,220	63	29	18"	45	0.22	1.66	20"	11"	435.00
◇ EAFC5151830-400	15 mil	0.38	4,000	1,220	63	29	18"	45	0.30	2.22	20"	11"	435.00
◇ EAFC5152417-400	15 mil	0.38	4,000	1,220	63	29	24"	60	0.17	1.25	20"	11"	435.00
◇ EAFC5152422-400	15 mil	0.38	4,000	1,220	63	29	24"	60	0.22	1.67	20"	11"	435.00

XXX or XX denotes the flow rate in gpm per 100 feet (Q-100) @ 10 psi. Substitute XXX or XX with the flow rates available for each spacing, indicated in the gpm Q-100 column. Example: EAFC5150867-400 (Aqua-Traxx FC 5/8"; 15 mil; 8" spacing; 0.67 gpm Q-100; 4,000 Ft. Coil)



Drip Tape



Aqua-Traxx FC (Category I) Flow Control Drip Tape

◇ **MADE TO ORDER.** US\$ 7,500.00 minimum order value will apply. Toro Micro-Irrigation Customer Service will confirm by Fax that the order has been accepted and the estimated date of delivery.
Flow rate expressed in gpm per 100 feet (Q-100) @ 10 psi (0.7 Bar).



Part Number	Wall Thickness		Reel Length		Reel Weight		Spacing		Available Flow Rates		Reel		List Price Per Reel
	mil	mm	Ft.	M	Lbs.	Kilos	in	cm	gpm Q-100 feet	liters / hour-meter	Dia.	Height	
7/8" Diameter (22mm)													
◇ EAFC7081625-600	8 mil	0.20	6,000	1,829	72	33	16"	40	0.25	1.86	20"	11"	470.00
◇ EAFC7081634-600	8 mil	0.20	6,000	1,829	72	33	16"	40	0.34	2.5	20"	11"	470.00
◇ EAFC7081822-600	8 mil	0.20	6,000	1,829	72	33	18"	45	0.22	1.66	20"	11"	470.00
◇ EAFC7081830-600	8 mil	0.20	6,000	1,829	72	33	18"	45	0.30	2.22	20"	11"	470.00
◇ EAFC7082417-600	8 mil	0.20	6,000	1,829	72	33	24"	60	0.17	1.25	20"	11"	470.00
◇ EAFC7082422-600	8 mil	0.20	6,000	1,829	72	33	24"	60	0.22	1.67	20"	11"	470.00
◇ EAFC7101625-440	10 mil	0.25	4,400	1,341	71	32	16"	40	0.25	1.86	20"	11"	430.00
◇ EAFC7101634-440	10 mil	0.25	4,400	1,341	71	32	16"	40	0.34	2.5	20"	11"	430.00
◇ EAFC7101822-440	10 mil	0.25	4,400	1,341	71	32	18"	45	0.22	1.66	20"	11"	430.00
◇ EAFC7101830-440	10 mil	0.25	4,400	1,341	71	32	18"	45	0.30	2.22	20"	11"	430.00
◇ EAFC7102417-440	10 mil	0.25	4,400	1,341	71	32	24"	60	0.17	1.25	20"	11"	430.00
◇ EAFC7102422-440	10 mil	0.25	4,400	1,341	71	32	24"	60	0.22	1.67	20"	11"	430.00
◇ EAFC7120667-400	12 mil	0.30	4,000	1,220	72	33	6"	15	0.67	4.99	20"	11"	440.00
◇ EAFC7120690-400	12 mil	0.30	4,000	1,220	72	33	6"	15	0.90	6.66	20"	11"	440.00
◇ EAFC7120850-400	12 mil	0.30	4,000	1,220	72	33	8"	20	0.50	3.74	20"	11"	440.00
◇ EAFC7120867-400	12 mil	0.30	4,000	1,220	72	33	8"	20	0.67	4.99	20"	11"	440.00
◇ EAFC7121234-400	12 mil	0.30	4,000	1,220	72	33	12"	30	0.34	2.50	20"	11"	440.00
◇ EAFC7121245-400	12 mil	0.30	4,000	1,220	72	33	12"	30	0.45	3.33	20"	11"	440.00
◇ EAFC7121625-400	12 mil	0.30	4,000	1,220	72	33	16"	40	0.25	1.86	20"	11"	440.00
◇ EAFC7121634-400	12 mil	0.30	4,000	1,220	72	33	16"	40	0.34	2.50	20"	11"	440.00
◇ EAFC7121822-400	12 mil	0.30	4,000	1,220	72	33	18"	45	0.22	1.66	20"	11"	440.00
◇ EAFC7121830-400	12 mil	0.30	4,000	1,220	72	33	18"	45	0.30	2.22	20"	11"	440.00
◇ EAFC7122417-400	12 mil	0.30	4,000	1,220	72	33	24"	60	0.17	1.25	20"	11"	440.00
◇ EAFC7122422-400	12 mil	0.30	4,000	1,220	72	33	24"	60	0.22	1.67	20"	11"	440.00
◇ EAFC7150667-300	15 mil	0.38	3,000	914	66	30	6"	15	0.67	4.99	20"	11"	383.00
◇ EAFC7150690-300	15 mil	0.38	3,000	914	66	30	6"	15	0.90	6.66	20"	11"	383.00
◇ EAFC7150850-300	15 mil	0.38	3,000	914	66	30	8"	20	0.50	3.74	20"	11"	383.00
◇ EAFC7150867-300	15 mil	0.38	3,000	914	66	30	8"	20	0.67	4.99	20"	11"	383.00
◇ EAFC7151234-300	15 mil	0.38	3,000	914	66	30	12"	30	0.34	2.50	20"	11"	383.00
◇ EAFC7151245-300	15 mil	0.38	3,000	914	66	30	12"	30	0.45	3.33	20"	11"	383.00
◇ EAFC7151625-300	15 mil	0.38	3,000	914	66	30	16"	40	0.25	1.86	20"	11"	383.00
◇ EAFC7151634-300	15 mil	0.38	3,000	914	66	30	16"	40	0.34	2.50	20"	11"	383.00
◇ EAFC7151822-300	15 mil	0.38	3,000	914	66	30	18"	45	0.22	1.66	20"	11"	383.00
◇ EAFC7151830-300	15 mil	0.38	3,000	914	66	30	18"	45	0.30	2.22	20"	11"	383.00
◇ EAFC7152417-300	15 mil	0.38	3,000	914	66	30	24"	60	0.17	1.25	20"	11"	383.00
◇ EAFC7152422-300	15 mil	0.38	3,000	914	66	30	24"	60	0.22	1.67	20"	11"	383.00

XXX or XX denotes the flow rate in gpm per 100 feet (Q-100) @ 10 psi. Substitute XXX or XX with the flow rates available for each spacing, indicated in the gpm Q-100 column. Example: EAP5150867-400 (Aqua-Traxx PC 5/8"; 15 mil; 8" spacing; 0.67 gpm Q-100; 4,000 Ft. Coil)



The latest evolution in **precision.**



Drip Tape



Aqua-Traxx FC (Category I) Flow Control Drip Tape

◆ **MADE TO ORDER.** US\$ 7,500.00 minimum order value will apply. Toro Micro-Irrigation Customer Service will confirm by Fax that the order has been accepted and the estimated date of delivery.
Flow rate expressed in gpm per 100 feet (Q-100) @ 10 psi (0.7 Bar).



Part Number	Wall Thickness		Reel Length		Reel Weight		Spacing		Available Flow Rates		Reel		List Price Per Reel
	mil	mm	Ft.	M	Lbs.	Kilos	in	cm	gpm Q-100 feet	liters / hour-meter	Dia.	Height	
1-3/8" Diameter (35mm)													
◆ EAFC11150667-270	15 mil	0.38	2,700	823	87	39	6"	15	0.67	4.99	20"	13"	575.00
◆ EAFC11150690-270	15 mil	0.38	2,700	823	87	39	6"	15	0.90	6.66	20"	13"	575.00
◆ EAFC11150850-270	15 mil	0.38	2,700	823	87	39	8"	20	0.50	3.74	20"	13"	575.00
◆ EAFC11150867-270	15 mil	0.38	2,700	823	87	39	8"	20	0.67	4.99	20"	13"	575.00
◆ EAFC11151234-270	15 mil	0.38	2,700	823	87	39	12"	30	0.34	2.50	20"	13"	575.00
◆ EAFC11151245-270	15 mil	0.38	2,700	823	87	39	12"	30	0.45	3.33	20"	13"	575.00
◆ EAFC11151625-270	15 mil	0.38	2,700	823	87	39	16"	40	0.25	1.86	20"	13"	575.00
◆ EAFC11151634-270	15 mil	0.38	2,700	823	87	39	16"	40	0.34	2.50	20"	13"	575.00
◆ EAFC11151822-270	15 mil	0.38	2,700	823	87	39	18"	45	0.22	1.66	20"	13"	575.00
◆ EAFC11151830-270	15 mil	0.38	2,700	823	87	39	18"	45	0.30	2.22	20"	13"	575.00
◆ EAFC11152417-270	15 mil	0.38	2,700	823	87	39	24"	60	0.17	1.25	20"	13"	575.00
◆ EAFC11152422-270	15 mil	0.38	2,700	823	87	39	24"	60	0.22	1.67	20"	13"	575.00

XXX or XX denotes the flow rate in gpm per 100 feet (Q-100) @ 10 psi. Substitute XXX or XX with the flow rates available for each spacing, indicated in the gpm Q-100 column. Example: EAFC1150867-400 (Aqua-Traxx FC 5/8"; 15 mil; 8" spacing; 0.67 gpm Q-100; 4,000 Ft. Coil)

Aqua-Traxx FC - Full Reel Shipping Information

Aqua-Traxx FC Dimensions:	1 Reel	Dia. 20" x H 11"		Reels per 20' container						
Reels per Pallet	16 Reels	B 43" x W 43" x H 50"		Aqua-Traxx FC						
	32 Reels	(16 x 2) or 28 Reels (16 + 12)		4mil	5mil	6mil	8mil	10mil	12mil	15mil
				5/8"		280	280	280	280	280
				7/8"			280	280	280	280
				1-3/8"						280
Reels per truck load (approx. 53')				Reels per 40' container						
Aqua-Traxx FC	4mil	5mil	6mil	8mil	10mil	12mil	15mil	Aqua-Traxx FC		
5/8"		640	640	640	640			640	640	640
7/8"			640	640	640			640	640	640
1-3/8"					480					480

Aqua Traxx FC Flow Rates Available in 6, 8, 10, 12 & 15 mil Tape								
Emitter Flow Part Number	Outlet Spacing		Emitter Flow Rate		Q-100		Emitter Exponent	Filtration Requirement mesh (micron)
	in	cm	gph @ 10 psi	lph @ 0.7 bar	gpm / 100 ft @ 10 psi	lph / 1 meter @ 0.7 bar		
0.20 gph emitter								
EAFCXxx0667	6	15	0.20	0.76	0.67	4.99	0.3	150 (98)
EAFCXxx0850	8	20	0.20	0.76	0.50	3.74		
EAFCXxx1234	12	30	0.20	0.76	0.34	2.50		
EAFCXxx1625	16	40	0.20	0.76	0.25	1.87		
EAFCXxx1822	18	45	0.20	0.76	0.22	1.67		
EAFCXxx2417	24	60	0.20	0.76	0.17	1.25		
0.27 gph emitter								
EAFCXxx0690	6	15	0.27	1.01	0.90	6.66	0.3	150 (98)
EAFCXxx0867	8	20	0.27	1.01	0.67	4.99		
EAFCXxx1245	12	30	0.27	1.01	0.45	3.33		
EAFCXxx1634	16	40	0.27	1.01	0.34	2.50		
EAFCXxx1830	18	45	0.27	1.01	0.30	2.22		
EAFCXxx2422	24	60	0.27	1.01	0.22	1.67		

* X denotes the diameter. 5 for 5/8", 7 for 7/8", 8 for 1" and 11 for 1-3/8"
 ** xx denotes mil thickness.
 *** 1" only available in 13 mil.
 Metric outlet spacing expressed in nominal length.



Drip Tape

Aqua-Traxx®
with the PBX Advantage

Aqua-Traxx with the PBX Advantage (Category I)

Non-Pressure Compensating Drip Tape

STOCKED ITEMS. PRODUCT GENERALLY AVAILABLE IN STOCK

Flow rate expressed in gpm per 100 feet (Q-100) @ 8 psi (0.55 Bar).



Part Number	Wall Thickness		Reel Length		Reel Weight		Spacing		Available Flow Rates		Reel		List Price Per Reel
	mil	mm	Ft.	M	Lbs.	Kilos	in	cm	gpm Q-100 feet	liters / hour-meter	Dia.	Height	
5/8" Diameter (16mm)													
EA5040467-1500	4 mil	0.10	15,000	4,572	66	30	4"	10	0.67	4.99	20"	11"	543.00
EA5040867-1500	4 mil	0.10	15,000	4,572	66	30	8"	20	0.67	4.99	20"	11"	543.00
EA50504134-1300	5 mil	0.13	13,000	3,962	72	33	4"	10	1.34	9.99	20"	11"	496.00
EA5050467-1300	5 mil	0.13	13,000	3,962	72	33	4"	10	0.67	4.99	20"	11"	496.00
EA5050650-1300	5 mil	0.13	13,000	3,962	72	33	6"	15	0.50	3.73	20"	11"	496.00
EA5050667-1300	5 mil	0.13	13,000	3,962	72	33	6"	15	0.67	4.99	20"	11"	496.00
EA5050817-1300	5 mil	0.13	13,000	3,962	72	33	8"	20	0.17	1.30	20"	11"	516.00
EA5050822-1300	5 mil	0.13	13,000	3,962	72	33	8"	20	0.22	1.66	20"	11"	516.00
EA5050825-1300	5 mil	0.13	13,000	3,962	72	33	8"	20	0.25	1.86	20"	11"	516.00
EA5050834-1300	5 mil	0.13	13,000	3,962	72	33	8"	20	0.34	2.50	20"	11"	496.00
EA5050850-1300	5 mil	0.13	13,000	3,962	72	33	8"	20	0.50	3.74	20"	11"	496.00
EA5050867-1300	5 mil	0.13	13,000	3,962	72	33	8"	20	0.67	4.99	20"	11"	496.00
EA5051222-1300	5 mil	0.13	13,000	3,962	72	33	12"	30	0.22	1.66	20"	11"	496.00
EA5051234-1300	5 mil	0.13	13,000	3,962	72	33	12"	30	0.34	2.5	20"	11"	496.00
EA5051245-1300	5 mil	0.13	13,000	3,962	72	33	12"	30	0.45	3.33	20"	11"	496.00
EA50604134-1000	6 mil	0.15	10,000	3,048	64	29	4"	10	1.34	9.99	20"	11"	438.00
EA5060467-1000	6 mil	0.15	10,000	3,048	64	29	4"	10	0.67	4.99	20"	11"	438.00
EA5060650-1000	6 mil	0.15	10,000	3,048	64	29	6"	15	0.50	3.73	20"	11"	438.00
EA5060667-1000	6 mil	0.15	10,000	3,048	64	29	6"	15	0.67	4.99	20"	11"	438.00
EA5060817-1000	6 mil	0.15	10,000	3,048	64	29	8"	20	0.17	1.30	20"	11"	457.00
EA5060822-1000	6 mil	0.15	10,000	3,048	64	29	8"	20	0.22	1.66	20"	11"	457.00
EA5060825-1000	6 mil	0.15	10,000	3,048	64	29	8"	20	0.25	1.86	20"	11"	457.00
EA5060834-1000	6 mil	0.15	10,000	3,048	64	29	8"	20	0.34	2.50	20"	11"	438.00
EA5060850-1000	6 mil	0.15	10,000	3,048	64	29	8"	20	0.50	3.74	20"	11"	438.00
EA5060867-1000	6 mil	0.15	10,000	3,048	64	29	8"	20	0.67	4.99	20"	11"	438.00
EA5060884-1000	6 mil	0.15	10,000	3,048	64	29	8"	20	0.84	6.24	20"	11"	438.00
EA5061222-1000	6 mil	0.15	10,000	3,048	64	29	12"	30	0.22	1.66	20"	11"	438.00
EA5061234-1000	6 mil	0.15	10,000	3,048	64	29	12"	30	0.34	2.50	20"	11"	438.00
EA5061245-1000	6 mil	0.15	10,000	3,048	64	29	12"	30	0.45	3.33	20"	11"	438.00
EA50804134-750	8 mil	0.20	7,500	2,286	66	30	4"	10	1.34	9.99	20"	11"	400.00
EA5080467-750	8 mil	0.20	7,500	2,286	66	30	4"	10	0.67	4.99	20"	11"	400.00
EA5080650-750	8 mil	0.20	7,500	2,286	66	30	6"	15	0.50	3.73	20"	11"	400.00
EA5080667-750	8 mil	0.20	7,500	2,286	66	30	6"	15	0.67	4.99	20"	11"	400.00
EA5080817-750	8 mil	0.20	7,500	2,286	66	30	8"	20	0.17	1.30	20"	11"	419.00
EA5080825-750	8 mil	0.20	7,500	2,286	66	30	8"	20	0.25	1.86	20"	11"	419.00
EA5080834-750	8 mil	0.20	7,500	2,286	66	30	8"	20	0.34	2.50	20"	11"	400.00
EA5080850-750	8 mil	0.20	7,500	2,286	66	30	8"	20	0.50	3.74	20"	11"	400.00
EA5080867-750	8 mil	0.20	7,500	2,286	66	30	8"	20	0.67	4.99	20"	11"	400.00
EA5081222-750	8 mil	0.20	7,500	2,286	66	30	12"	30	0.22	1.66	20"	11"	400.00
EA5081245-750	8 mil	0.20	7,500	2,286	66	30	12"	30	0.45	3.33	20"	11"	400.00
EA5101245-600	10 mil	0.25	6,000	1,829	63	29	12"	30	0.45	3.33	20"	11"	400.00
EA51508XX-400	15 mil	0.38	4,000	1,220	63	29	8"	20	0.34	2.5	20"	11"	400.00
7/8" Diameter (22mm)													
EA7061234-738	6mil	0.15	7,380	2,250	68	31	12"	30	0.34	2.50	20"	11"	406.00
EA7060834-738	6mil	0.15	7,380	2,250	68	31	8"	20	0.34	2.50	20"	11"	406.00
EA7061222-738	6mil	0.15	7,380	2,250	68	31	12"	30	0.22	1.66	20"	11"	406.00
EA7080650-600	8 mil	0.20	6,000	1,829	72	33	6"	15	0.50	3.73	20"	11"	424.00
EA7080834-600	8 mil	0.20	6,000	1,829	72	33	8"	20	0.34	2.50	20"	11"	424.00
EA7080867-600	8 mil	0.20	6,000	1,829	72	33	8"	20	0.67	4.99	20"	11"	424.00
EA7081234-600	8 mil	0.20	6,000	1,829	72	33	12"	30	0.34	2.50	20"	11"	424.00
EA7100834-440	10 mil	0.25	4,400	1,341	71	32	8"	20	0.34	2.50	20"	11"	381.00
EA7101234-440	10 mil	0.25	4,400	1,341	71	32	12"	30	0.34	2.5	20"	11"	381.00



Drip Tape



Aqua-Traxx with the PBX Advantage (Category I)
Non-Pressure Compensating Drip Tape

◇ **MADE TO ORDER.** US\$ 7,500.00 minimum order value will apply.

Toro Micro-Irrigation Customer Service will confirm by Fax that the order has been accepted and the estimated date of delivery.

Flow rate expressed in gpm per 100 feet (Q-100) @ 8 psi (0.55 Bar).

Part Number	Wall Thickness		Reel Length		Reel Weight		Spacing		Available Flow Rates		Reel		List Price
	mil	mm	Ft.	M	Lbs.	Kilos	in	cm	gpm Q-100 feet	liters / hour-meter	Dia.	Height	
◇ EA51204XXX-510	12 mil	0.30	5,100	1,554	63	29	4"	10	1.34 ; 2.65	9.99 ; 19.75	20"	11"	400.00
◇ EA51206XXX-510	12 mil	0.30	5,100	1,554	63	29	6"	15	1.12	8.33	20"	11"	400.00
◇ EA51206XX-510	12 mil	0.30	5,100	1,554	63	29	6"	15	0.44 ; 0.50 ; 0.67 ; 0.90	3.33 ; 3.74 ; 4.99 ; 6.66	20"	11"	400.00
◇ EA51208XXX-510	12 mil	0.30	5,100	1,554	63	29	8"	20	1.33	9.87	20"	11"	400.00
◇ EA51208XX-510	12 mil	0.30	5,100	1,554	63	29	8"	20	0.84 ; 0.67 ; 0.50 ; 0.34	6.24 ; 4.99 ; 3.74 ; 2.50	20"	11"	400.00
◇ EA5120817-510	12 mil	0.30	5,100	1,554	63	29	8"	20	0.17	1.30	20"	11"	419.00
◇ EA5120822-510	12 mil	0.30	5,100	1,554	63	29	8"	20	0.22	1.66	20"	11"	419.00
◇ EA5120825-510	12 mil	0.30	5,100	1,554	63	29	8"	20	0.25	1.86	20"	11"	419.00
◇ EA51212XX-510	12 mil	0.30	5,100	1,554	63	29	12"	30	0.56 ; 0.45 ; 0.34 ; 0.22 ; 0.88	4.16 ; 3.33 ; 2.50 ; 1.66 ; 6.58	20"	11"	400.00
◇ EA51216XX-510	12 mil	0.30	5,100	1,554	63	29	16"	40	0.42 ; 0.34 ; 0.25 ; 0.17 ; 0.66	3.12 ; 2.50 ; 1.87 ; 1.66 ; 4.94	20"	11"	400.00
◇ EA51218XX-510	12 mil	0.30	5,100	1,554	63	29	18"	45	0.14 ; 0.17 ; 0.22 ; 0.30	1.11 ; 1.25 ; 1.67 ; 2.22	20"	11"	400.00
◇ EA51224XX-510	12 mil	0.30	5,100	1,554	63	29	24"	60	0.28 ; 0.22 ; 0.17 ; 0.11 ; 0.44	2.08 ; 1.67 ; 1.25 ; 0.83 ; 3.29	20"	11"	400.00
◇ EA51504XXX-400	15 mil	0.38	4,000	1,220	63	29	4"	10	1.34 ; 2.65	9.99 ; 19.75	20"	11"	400.00
◇ EA51506XXX-400	15 mil	0.38	4,000	1,220	63	29	6"	15	1.12	8.33	20"	11"	400.00
◇ EA51506XX-400	15 mil	0.38	4,000	1,220	63	29	6"	15	0.44 ; 0.50 ; 0.67 ; 0.90	3.33 ; 3.74 ; 4.99 ; 6.66	20"	11"	400.00
◇ EA51508XXX-400	15 mil	0.38	4,000	1,220	63	29	8"	20	1.33	9.87	20"	11"	400.00
◇ EA51508XX-400	15 mil	0.38	4,000	1,220	63	29	8"	20	0.84 ; 0.67 ; 0.50	6.24 ; 4.99 ; 3.74	20"	11"	400.00
◇ EA5150817-400	15 mil	0.38	4,000	1,220	63	29	8"	20	0.17	1.30	20"	11"	419.00
◇ EA5150822-400	15 mil	0.38	4,000	1,220	63	29	8"	20	0.22	1.66	20"	11"	419.00
◇ EA5150825-400	15 mil	0.38	4,000	1,220	63	29	8"	20	0.25	1.86	20"	11"	419.00
◇ EA51512XX-400	15 mil	0.38	4,000	1,220	63	29	12"	30	0.56 ; 0.45 ; 0.34 ; 0.22 ; 0.88	4.16 ; 3.33 ; 2.50 ; 1.66 ; 6.58	20"	11"	400.00
◇ EA51516XX-400	15 mil	0.38	4,000	1,220	63	29	16"	40	0.42 ; 0.34 ; 0.25 ; 0.17 ; 0.66	3.12 ; 2.50 ; 1.87 ; 1.66 ; 4.94	20"	11"	400.00
◇ EA51518XX-400	15 mil	0.38	4,000	1,220	63	29	18"	45	0.14 ; 0.17 ; 0.22 ; 0.30	1.11 ; 1.25 ; 1.67 ; 2.22	20"	11"	400.00
◇ EA51524XX-400	15 mil	0.38	4,000	1,220	63	29	24"	60	0.28 ; 0.22 ; 0.17 ; 0.11 ; 0.44	2.08 ; 1.67 ; 1.25 ; 0.83 ; 3.29	20"	11"	400.00

XXX or XX denotes the flow rate in gpm per 100 feet (Q-100) @ 8 psi. Substitute XXX or XX with the flow rates available for each spacing, indicated in the gpm Q-100 column. Example: EA51204134-510 (Aqua-TraXX 5/8"; 12 mil; 4" spacing; 1.34 gpm Q-100; 5,100 Ft. Coil) or EA5120850-510 (Aqua-TraXX 5/8"; 12 mil; 8" spacing; 0.50 gpm Q-100; 5,100 Ft. Coil).

Note: Aqua-Traxx products with flow rates of 0817, 0822, and 0825 have higher list prices than other flows.



Drip Tape



Aqua-Traxx with the PBX Advantage (Category I)

Non-Pressure Compensating Drip Tape

◇ **MADE TO ORDER.** US\$ 7,500.00 minimum order value will apply. Toro Micro-Irrigation Customer Service will confirm by Fax that the order has been accepted and the estimated date of delivery.
Flow rate expressed in gpm per 100 feet (Q-100) @ 8 psi (0.55 Bar).



Part Number	Wall Thickness		Reel Length		Reel Weight		Spacing		Available Flow Rates		Reel		List Price
	mil	mm	Ft.	M	Lbs.	Kilos	inches	cm	gpm Q-100 feet	liters / hour-meter	Dia.	Height	
1" Diameter (25mm)													
◇ EA81304XXX-300	13 mil	0.33	3,000	914	66	30	4"	10	1.34 ; 2.65	9.99 ; 19.75	20"	11"	388.00
◇ EA81306XXX-300	13 mil	0.33	3,000	914	66	30	6"	10	1.12	8.33	20"	11"	388.00
◇ EA81306XXX-300	13 mil	0.33	3,000	914	66	30	6"	10	0.44 ; 0.50 ; 0.67 ; 0.90	3.33 ; 3.78 ; 4.99 ; 6.66	20"	11"	388.00
◇ EA81308XXX-300	13 mil	0.33	3,000	914	66	30	8"	20	1.33	9.87	20"	11"	388.00
◇ EA81308XXX-300	13 mil	0.33	3,000	914	66	30	8"	20	0.84 ; 0.67 ; 0.50 ; 0.34	6.24 ; 4.99 ; 3.74 ; 2.50	20"	11"	388.00
◇ EA8130817-300	13 mil	0.33	3,000	914	66	30	8"	20	0.17	1.30	20"	11"	404.00
◇ EA8130822-300	13 mil	0.33	3,000	914	66	30	8"	20	0.22	1.66	20"	11"	404.00
◇ EA8130825-300	13 mil	0.33	3,000	914	66	30	8"	20	0.25	1.86	20"	11"	404.00
◇ EA81312XX-300	13 mil	0.33	3,000	914	66	30	12"	30	0.56 ; 0.45 ; 0.34 ; 0.22 ; 0.88	4.16 ; 3.33 ; 2.50 ; 1.66 ; 6.58	20"	11"	388.00
◇ EA81316XX-300	13 mil	0.33	3,000	914	66	30	16"	40	0.42 ; 0.34 ; 0.25 ; 0.17 ; 0.66	3.12 ; 2.50 ; 1.87 ; 1.25 ; 4.94	20"	11"	388.00
◇ EA81318XX-300	13 mil	0.33	3,000	914	66	30	18"	45	0.14 ; 0.17 ; 0.22 ; 0.30	1.11 ; 1.24 ; 1.67 ; 2.22	20"	11"	388.00
◇ EA81324XX-300	13 mil	0.33	3,000	914	66	30	24"	60	0.28 ; 0.22 ; 0.17 ; 0.11 ; 0.44	2.08 ; 1.67 ; 1.25 ; 0.83 ; 3.29	20"	11"	388.00
1-1/8" Diameter (28mm)													
◇ EA91504XXX-300	15 mil	0.38	3,000	914	71	32	4"	10	1.34 ; 2.65	9.99 ; 19.75	20"	13"	384.00
◇ EA91506XXX-300	15 mil	0.38	3,000	914	71	32	6"	10	1.12	8.33	20"	13"	384.00
◇ EA91506XXX-300	15 mil	0.38	3,000	914	71	32	6"	10	0.44 ; 0.50 ; 0.67 ; 0.90	3.33 ; 3.78 ; 4.99 ; 6.66	20"	13"	384.00
◇ EA91508XXX-300	15 mil	0.38	3,000	914	71	32	8"	20	1.33	9.87	20"	13"	384.00
◇ EA91508XXX-300	15 mil	0.38	3,000	914	71	32	8"	20	0.84 ; 0.67 ; 0.50 ; 0.34	6.24 ; 4.99 ; 3.74 ; 2.50	20"	13"	384.00
◇ EA9150817-300	15 mil	0.38	3,000	914	71	32	8"	20	0.17	1.30	20"	13"	400.00
◇ EA9150822-300	15 mil	0.38	3,000	914	71	32	8"	20	0.22	1.66	20"	13"	400.00
◇ EA9150825-300	15 mil	0.38	3,000	914	71	32	8"	20	0.25	1.86	20"	13"	400.00
◇ EA91512XX-300	15 mil	0.38	3,000	914	71	32	12"	30	0.56 ; 0.45 ; 0.34 ; 0.22 ; 0.88	4.16 ; 3.33 ; 2.50 ; 1.66 ; 6.58	20"	13"	384.00
◇ EA91516XX-300	15 mil	0.38	3,000	914	71	32	16"	40	0.42 ; 0.34 ; 0.25 ; 0.17 ; 0.66	3.12 ; 2.50 ; 1.87 ; 1.25 ; 4.94	20"	13"	384.00
◇ EA91518XX-300	15 mil	0.38	3,000	914	71	32	18"	45	0.14 ; 0.17 ; 0.22 ; 0.30	1.11 ; 1.24 ; 1.67 ; 2.22	20"	13"	384.00
◇ EA91524XX-300	15 mil	0.38	3,000	914	71	32	24"	60	0.28 ; 0.22 ; 0.17 ; 0.11 ; 0.44	2.08 ; 1.67 ; 1.25 ; 0.83 ; 3.29	20"	13"	384.00
1-3/8" Diameter (35mm)													
◇ EA111504XXX-270	15 mil	0.38	2,700	823	87	39	4"	10	1.34 ; 2.65	9.99 ; 19.75	20"	13"	533.00
◇ EA111506XXX-270	15 mil	0.38	2,700	823	87	39	6"	10	1.12	8.33	20"	13"	533.00
◇ EA111506XX-270	15 mil	0.38	2,700	823	87	39	6"	10	0.44 ; 0.50 ; 0.67 ; 0.90	3.33 ; 3.78 ; 4.99 ; 6.66	20"	13"	533.00
◇ EA111508XXX-270	15 mil	0.38	2,700	823	87	39	8"	20	1.33	9.87	20"	13"	533.00
◇ EA111508XX-270	15 mil	0.38	2,700	823	87	39	8"	20	0.84 ; 0.67 ; 0.50 ; 0.34	6.24 ; 4.99 ; 3.74 ; 2.50	20"	13"	533.00
◇ EA11150817-270	15 mil	0.38	2,700	823	87	39	8"	20	0.17	1.30	20"	13"	554.00
◇ EA11150822-270	15 mil	0.38	2,700	823	87	39	8"	20	0.22	1.66	20"	13"	554.00
◇ EA11150825-270	15 mil	0.38	2,700	823	87	39	8"	20	0.25	1.86	20"	13"	554.00
◇ EA111512XX-270	15 mil	0.38	2,700	823	87	39	12"	30	0.56 ; 0.45 ; 0.34 ; 0.22 ; 0.88	4.16 ; 3.33 ; 2.50 ; 1.66 ; 6.58	20"	13"	533.00
◇ EA111516XX-270	15 mil	0.38	2,700	823	87	39	16"	40	0.42 ; 0.34 ; 0.25 ; 0.17 ; 0.66	3.12 ; 2.50 ; 1.87 ; 1.25 ; 4.94	20"	13"	533.00
◇ EA111518XX-270	15 mil	0.38	2,700	823	87	39	18"	45	0.14 ; 0.17 ; 0.22 ; 0.30	1.11 ; 1.24 ; 1.67 ; 2.22	20"	13"	533.00
◇ EA111524XX-270	15 mil	0.38	2,700	823	87	39	24"	60	0.28 ; 0.22 ; 0.17 ; 0.11 ; 0.44	2.08 ; 1.67 ; 1.25 ; 0.83 ; 3.29	20"	13"	533.00

XXX or XX denotes the flow rate in gpm per 100 feet (Q-100) @ 8 psi. Substitute XXX or XX with the flow rates available for each spacing, indicated in the gpm Q-100 column. Example: EA71204134-400 (Aqua-TraxX 7/8"; 12 mil; 4" spacing; 1.34 gpm Q-100; 4,000 Ft. Coil) or EA7120850-400 (Aqua-TraxX 7/8"; 12 mil; 8" spacing; 0.50 gpm Q-100; 4,000 Ft. Coil).

Note: Aqua-Traxx products with flow rates of 0817, 0822, and 0825 have higher list prices than other flows.

Aqua-Traxx® - Full Reel Shipping Information

Aqua-Traxx Dimensions:	1 Reel		Dia. 20" x H 11"		Reels per 20' container												
	16 Reels	32 Reels	B 43" x W 43" x H 50"	(16 x 2) or 28 Reels (16 + 12)	Aqua-Traxx	4mil	5mil	6mil	8mil	10mil	12mil	13mil	15mil				
Reels per Pallet					5/8"	280	280	280	280	280	280		280				
					7/8"					280	280		280				
					1"							280					
					1-1/8"								280				
					1-3/8"								280				
Reels per truck load (approx. 53')					Reels per 40' container												
Aqua-Traxx	4mil	5mil	6mil	8mil	10mil	12mil	13mil	15mil	Aqua-Traxx	4mil	5mil	6mil	8mil	10mil	12mil	13mil	15mil
5/8"	608	608	640	640	640	640		640	5/8"	608	608	640	640	640	640		640
7/8"			640	640	640			640	7/8"			640	640	640	640		640
1"						640			1"							640	
1-1/8"								480	1-1/8"								480
1-3/8"								480	1-3/8"								480



Drip Tape

Aqua-Traxx®
with the PBX Advantage

Aqua-Traxx with the PBX Advantage - Short Reels (Category I)
Non-Pressure Compensating Drip Tape

◇ **MADE TO ORDER.** US\$ 7,500.00 minimum order value will apply. Toro Micro-Irrigation Customer Service will confirm by Fax that the order has been accepted and the estimated date of delivery.
Flow rate expressed in gpm per 100 feet (Q-100) @ 8 psi (0.55 Bar).

Part Number	Wall Thickness		Reel Length		Reel Weight		Spacing		Available Flow Rates		Reel		List Price Per Reel
	mil	mm	Ft.	M	Lbs.	Kilos	inches	cm	gpm Q-100 feet	liters / hour-meter	Dia.	Height	
5/8" Diameter (16mm) Wrapped Short Reels													
EA50604XXX-250	6 mil	0.15	2,500	762	17	7.7	4"	10	1.00	7.47	10"	11"	139.00
EA50606XX-250	6 mil	0.15	2,500	762	17	7.7	6"	15	0.50 ; 0.67	3.73 ; 4.99	10"	11"	139.00
EA50608XX-250	6 mil	0.15	2,500	762	17	7.7	8"	20	0.34 ; 0.50 ; 0.67	2.50 ; 3.74 ; 4.99	10"	11"	139.00
EA50612XX-250	6 mil	0.15	2,500	762	17	7.7	12"	30	0.34 ; 0.45	2.50 ; 3.33	10"	11"	139.00
EA50804XXX-200	8 mil	0.20	2,000	610	17	7.7	4"	10	1.00	7.47	10"	11"	133.00
EA50806XX-200	8 mil	0.20	2,000	610	17	7.7	6"	15	0.50 ; 0.67	3.73 ; 4.99	10"	11"	133.00
EA50808XX-200	8 mil	0.20	2,000	610	17	7.7	8"	20	0.34 ; 0.50 ; 0.67	2.50 ; 3.74 ; 4.99	10"	11"	133.00
EA50812XX-200	8 mil	0.20	2,000	610	17	7.7	12"	30	0.34 ; 0.45	2.50 ; 3.33	10"	11"	133.00
EA51504XXX-100	15 mil	0.38	1,000	305	16	7.3	4"	10	1.00	7.47	10"	11"	127.00
EA51506XX-100	15 mil	0.38	1,000	305	16	7.3	6"	15	0.50 ; 0.67	3.73 ; 4.99	10"	11"	127.00
EA51508XX-100	15 mil	0.38	1,000	305	16	7.3	8"	20	0.34 ; 0.50 ; 0.67	2.50 ; 3.74 ; 4.99	10"	11"	127.00
EA51512XX-100	15 mil	0.38	1,000	305	16	7.3	12"	30	0.34 ; 0.45	2.50 ; 3.33	10"	11"	127.00
5/8" Diameter (16mm) Boxed Short Reels													
EA50604XXX-250B	6 mil	0.15	2,500	762	17	7.7	4"	10	1.00	7.47	10"	11"	140.00
EA50606XX-250B	6 mil	0.15	2,500	762	17	7.7	6"	15	0.50 ; 0.67	3.73 ; 4.99	10"	11"	140.00
EA50608XX-250B	6 mil	0.15	2,500	762	17	7.7	8"	20	0.34 ; 0.50 ; 0.67	2.50 ; 3.74 ; 4.99	10"	11"	140.00
EA50612XX-250B	6 mil	0.15	2,500	762	17	7.7	12"	30	0.34 ; 0.45	2.50 ; 3.33	10"	11"	140.00
EA50804XXX-200B	8 mil	0.20	2,000	610	17	7.7	4"	10	1.00	7.47	10"	11"	134.00
EA50806XX-200B	8 mil	0.20	2,000	610	17	7.7	6"	15	0.50 ; 0.67	3.73 ; 4.99	10"	11"	134.00
EA50808XX-200B	8 mil	0.20	2,000	610	17	7.7	8"	20	0.34 ; 0.50 ; 0.67	2.50 ; 3.74 ; 4.99	10"	11"	134.00
EA50812XX-200B	8 mil	0.20	2,000	610	17	7.7	12"	30	0.34 ; 0.45	2.50 ; 3.33	10"	11"	134.00
EA51504XXX-100B	15 mil	0.38	1,000	305	16	7.3	4"	10	1.00	7.47	10"	11"	128.00
EA51506XX-100B	15 mil	0.38	1,000	305	16	7.3	6"	15	0.50 ; 0.67	3.73 ; 4.99	10"	11"	128.00
EA51508XX-100B	15 mil	0.38	1,000	305	16	7.3	8"	20	0.34 ; 0.50 ; 0.67	2.50 ; 3.74 ; 4.99	10"	11"	128.00
EA51512XX-100B	15 mil	0.38	1,000	305	16	7.3	12"	30	0.34 ; 0.45	2.50 ; 3.33	10"	11"	128.00



XXX or XX denotes the flow rate in gpm per 100 feet (Q-100) @ 8 psi. Substitute XXX or XX with the flow rates available for each spacing, indicated in the gpm Q-100 column. Example: EA71204134-400 (Aqua-TraXX 7/8"; 12 mil; 4" spacing; 1.34 gpm Q-100; 4,000 Ft. Coil) or EA7120850-400 (Aqua-TraXX 7/8"; 12 mil; 8" spacing; 0.50 gpm Q-100; 4,000 Ft. Coil).

Note: Add suffix "B" to the end of the short reel part number to denote a boxed short reel of Aqua-Traxx tape.
Example: EA5060834-250B (Aqua-Traxx 5/8"s, 6 mil, 8" spacing, 0.34 gpm Q-100, 2,500 ft coil, packaged in a box).

Aqua-Traxx® - Short Reel Shipping Information

with the PBX Advantage

Aqua-Traxx Dimensions:	1 Reel	Dia. 10" x H 11"				Reels per 20' container					
Reels per Pallet	64 Reels	B 43" x W 43" x H 50"				Aqua-Traxx	6mil	8mil	10mil	12mil	15mil
						5/8"	1,120	1,120	1,120	1,120	1,120
Reels per truck load (approx. 53')						Reels per 40' container					
Aqua-Traxx	6mil	8mil	10mil	12mil	15mil	Aqua-Traxx	6mil	8mil	10mil	12mil	15mil
5/8"	2,432	2,432	2,432	2,560	2,560	5/8"	2432	2432	2432	2560	2560



To order, call Toro Micro-Irrigation
El Cajon, Ca: +1 (800) 333-8125 or +1 (619) 562-2950
Sanford, Fl: +1 (800) 806-6582 or +1 (407) 321-2901
List Prices are US\$. FOB Shipping Point. Effective November 19, 2014 (ALT002)

Drip Tape

Aqua-Traxx®
with the PBX Advantage

Quality. Reliability. Durability.

Aqua-Traxx®
with the **PBX Advantage**

TORO®

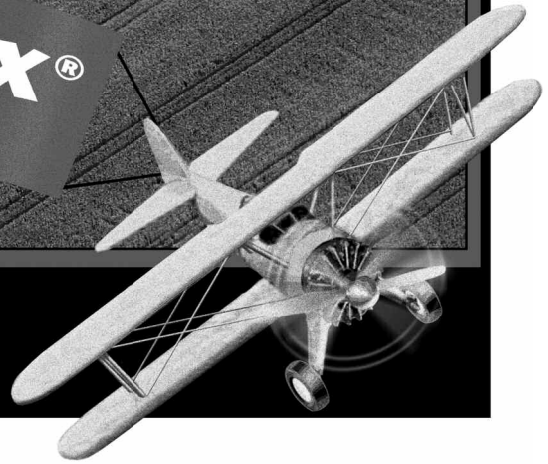

Drip Tape

Flow Rates Available in 4, 5, 6, 8, 10, 12 & 15 mil Tape												
Emitter Flow Part Number	Outlet Spacing		Emitter Flow Rate				Q-100		lph / 1 meter		Emitter Exponent	Filtration Requirement mesh (micron)
			gph		lph		gpm / 100 ft					
	in	cm	@ 8 psi	@ 10 psi	@ 0.55 bar	@ 0.7 bar	@ 8 psi	@ 10 psi	@ 0.55 bar	@ 0.7 bar		
0.07 gph emitter												
EAXxx0817	8	20	0.07	0.08	0.26	0.30	0.17	0.20	1.30	1.47	0.55	200 (74)
EAXxx1609	16	40	0.07	0.08	0.26	0.30	0.09	0.10	0.65	0.74		
0.09 gph emitter												
EAXxx0822	8	20	0.09	0.10	0.34	0.38	0.22	0.25	1.66	1.88	0.55	200 (74)
EAXxx1611	16	40	0.09	0.10	0.34	0.38	0.11	0.13	0.83	0.94		
0.10 gph emitter												
EAXxx0825	8	20	0.10	0.11	0.38	0.43	0.25	0.28	1.86	2.11	0.55	200 (74)
EAXxx1613	16	40	0.10	0.11	0.38	0.43	0.13	0.14	0.93	1.05		
0.13 gph emitter												
EAXxx0467	4	10	0.13	0.15	0.51	0.57	0.67	0.75	4.99	5.58	0.5	140 (105)
EAXxx0644	6	15	0.13	0.15	0.51	0.57	0.44	0.50	3.33	3.72		
EAXxx0834	8	20	0.13	0.15	0.51	0.57	0.34	0.37	2.50	2.79		
EAXxx1222	12	30	0.13	0.15	0.51	0.57	0.22	0.25	1.66	1.86		
EAXxx1617	16	40	0.13	0.15	0.51	0.57	0.17	0.19	1.25	1.40		
EAXxx1814	18	45	0.13	0.15	0.51	0.57	0.14	0.17	1.11	1.24		
EAXxx2411	24	60	0.13	0.15	0.51	0.57	0.11	0.12	0.83	0.93		
0.15 gph emitter												
EAXxx0650	6	15	0.15	0.17	0.57	0.63	0.50	0.56	3.73	4.17	0.5	140 (105)
EAXxx1225	12	30	0.15	0.17	0.57	0.63	0.25	0.28	1.86	2.08		
EAXxx1817	18	45	0.15	0.17	0.57	0.63	0.17	0.19	1.24	1.39		
0.20 gph emitter												
EAXxx04100	4	10	0.20	0.22	0.76	0.85	1.00	1.12	7.47	8.36	0.5	140 (105)
EAXxx0667	6	15	0.20	0.22	0.76	0.85	0.67	0.75	4.99	5.58		
EAXxx0850	8	20	0.20	0.22	0.76	0.85	0.50	0.56	3.74	4.18		
EAXxx1234	12	30	0.20	0.22	0.76	0.85	0.34	0.37	2.50	2.79		
EAXxx1625	16	40	0.20	0.22	0.76	0.85	0.25	0.28	1.87	2.09		
EAXxx1822	18	45	0.20	0.22	0.76	0.85	0.22	0.25	1.67	1.86		
EAXxx2417	24	60	0.20	0.22	0.76	0.85	0.17	0.19	1.25	1.40		
0.27 gph emitter												
EAXxx04134	4	10	0.27	0.30	1.01	1.13	1.34	1.50	9.99	11.16	0.5	140 (105)
EAXxx0690	6	15	0.27	0.30	1.01	1.13	0.90	1.00	6.66	7.44		
EAXxx0867	8	20	0.27	0.30	1.01	1.13	0.67	0.75	4.99	5.58		
EAXxx1245	12	30	0.27	0.30	1.01	1.13	0.45	0.50	3.33	3.72		
EAXxx1634	16	40	0.27	0.30	1.01	1.13	0.34	0.37	2.50	2.79		
EAXxx1830	18	45	0.27	0.30	1.01	1.13	0.30	0.33	2.22	2.48		
EAXxx2422	24	60	0.27	0.30	1.01	1.13	0.22	0.25	1.67	1.86		
0.34 gph emitter												
EAXxx04168	4	10	0.34	0.37	1.27	1.42	1.68	1.87	12.48	13.95	0.5	140 (105)
EAXxx06112	6	15	0.34	0.37	1.27	1.42	1.12	1.25	8.33	9.31		
EAXxx0884	8	20	0.34	0.37	1.27	1.42	0.84	0.94	6.24	6.98		
EAXxx1256	12	30	0.34	0.37	1.27	1.42	0.56	0.62	4.16	4.65		
EAXxx1642	16	40	0.34	0.37	1.27	1.42	0.42	0.47	3.12	3.49		
EAXxx1838	18	45	0.34	0.37	1.27	1.42	0.38	0.42	2.78	3.10		
EAXxx2428	24	60	0.34	0.37	1.27	1.42	0.28	0.31	2.08	2.33		
0.53 gph emitter												
EAXxx04265	4	10	0.53	0.59	2.01	2.24	2.65	2.96	19.75	22.08	0.5	140 (105)
EAXxx08133	8	20	0.53	0.59	2.01	2.24	1.33	1.48	9.87	11.04		
EAXxx1288	12	30	0.53	0.59	2.01	2.24	0.88	0.99	6.58	7.36		
EAXxx1666	16	40	0.53	0.59	2.01	2.24	0.66	0.74	4.94	5.52		
EAXxx2444	24	60	0.53	0.59	2.01	2.24	0.44	0.49	3.29	3.68		
EAXxx3629	36	90	0.53	0.59	2.01	2.24	0.29	0.33	2.19	2.45		

* X denotes the diameter. 5 for 5/8", 7 for 7/8", 8 for 1" and 11 for 1-3/8"
 ** xx denotes mil thickness.
 *** 1" only available in 13 mil.
 Metric outlet spacing expressed in nominal length.



To order, call Toro Micro-Irrigation
 El Cajon, Ca: +1 (800) 333-8125 or +1 (619) 562-2950
 Sanford, Fl: +1 (800) 806-6582 or +1 (407) 321-2901
 List Prices are US\$. FOB Shipping Point. Effective November 19, 2014 (ALT002)

Drip Tape

Aqua-Traxx Reorder Chart / Full Reels Per Acre

Row Spacing in ft		AT Family SKU Reel length ft	5/8" ID							7/8" ID					1" ID	1 1/8" ID	1 3/8" ID
			EA504 15,000	EA505 13,000	EA506 10,000	EA508 7,500	EA510 6,000	EA512 5,100	EA515 4,000	EA706 7,380	EA708 6,000	EA710 4,400	EA712 4,000	EA715 3,000	EA813 3,000	EA915 3,000	EA1115 2,700
30	2.50		1.16	1.34	1.74	2.32	2.90	3.42	4.36	2.36	2.90	4.36	4.36	5.81	5.81	5.81	6.45
32	2.67		1.09	1.26	1.63	2.18	2.72	3.20	4.08	2.21	2.72	3.71	4.08	5.45	5.45	5.45	6.05
34	2.83		1.02	1.18	1.54	2.05	2.56	3.01	3.84	2.08	2.56	3.49	3.84	5.12	5.12	5.12	5.69
36	3.00		0.97	1.12	1.45	1.94	2.42	2.85	3.63	1.97	2.42	3.30	3.63	4.84	4.84	4.84	5.38
38	3.17		0.92	1.06	1.38	1.83	2.29	2.70	3.44	1.86	2.29	3.13	3.44	4.59	4.59	4.59	5.09
40	3.33		0.87	1.01	1.31	1.74	2.18	2.56	3.27	1.77	2.18	2.97	3.27	4.36	4.36	4.36	4.84
42	3.50		0.83	0.96	1.24	1.66	2.07	2.44	3.11	1.69	2.07	2.83	3.11	4.15	4.15	4.15	4.61
44	3.67		0.79	0.91	1.19	1.58	1.98	2.33	2.97	1.61	1.98	2.70	2.97	3.96	3.96	3.96	4.40
46	3.83		0.76	0.87	1.14	1.52	1.89	2.23	2.84	1.54	1.89	2.58	2.84	3.79	3.79	3.79	4.21
48	4.00		0.73	0.84	1.09	1.45	1.82	2.14	2.72	1.48	1.82	2.48	2.72	3.63	3.63	3.63	4.03
50	4.17		0.70	0.80	1.05	1.39	1.74	2.05	2.61	1.42	1.74	2.38	2.61	3.48	3.48	3.48	3.87
52	4.33		0.67	0.77	1.01	1.34	1.68	1.97	2.51	1.36	1.68	2.28	2.51	3.35	3.35	3.35	3.72
54	4.50		0.65	0.74	0.97	1.29	1.61	1.90	2.42	1.31	1.61	2.20	2.42	3.23	3.23	3.23	3.59
56	4.67		0.62	0.72	0.93	1.24	1.56	1.83	2.33	1.26	1.56	2.12	2.33	3.11	3.11	3.11	3.46
58	4.83		0.60	0.69	0.90	1.20	1.50	1.77	2.25	1.22	1.50	2.05	2.25	3.00	3.00	3.00	3.34
60	5.00		0.58	0.67	0.87	1.16	1.45	1.71	2.18	1.18	1.45	1.98	2.18	2.90	2.90	2.90	3.23
62	5.17		0.56	0.65	0.84	1.12	1.41	1.65	2.11	1.14	1.41	1.92	2.11	2.81	2.81	2.81	3.12
64	5.33		0.54	0.63	0.82	1.09	1.36	1.60	2.04	1.11	1.36	1.86	2.04	2.72	2.72	2.72	3.03
66	5.50		0.53	0.61	0.79	1.06	1.32	1.55	1.98	1.07	1.32	1.80	1.98	2.64	2.64	2.64	2.93
68	5.67		0.51	0.59	0.77	1.02	1.28	1.51	1.92	1.04	1.28	1.75	1.92	2.56	2.56	2.56	2.85
70	5.83		0.50	0.57	0.75	1.00	1.24	1.46	1.87	1.01	1.24	1.70	1.87	2.49	2.49	2.49	2.77
72	6.00		0.48	0.56	0.73	0.97	1.21	1.42	1.82	0.98	1.21	1.65	1.82	2.42	2.42	2.42	2.69
74	6.17		0.47	0.54	0.71	0.94	1.18	1.39	1.77	0.96	1.18	1.61	1.77	2.35	2.35	2.35	2.62
76	6.33		0.46	0.53	0.69	0.92	1.15	1.35	1.72	0.93	1.15	1.56	1.72	2.29	2.29	2.29	2.55
78	6.50		0.45	0.52	0.67	0.89	1.12	1.31	1.68	0.91	1.12	1.52	1.68	2.23	2.23	2.23	2.48
80	6.67		0.44	0.50	0.65	0.87	1.09	1.28	1.63	0.89	1.09	1.49	1.63	2.18	2.18	2.18	2.42

To use this chart: Intersect row spacing on first column with product type from first row. Multiply the factor by acreage. The result will be the number of reels required for your next order.



Drip Tape Accessories

Aqua-Traxx Fusion System

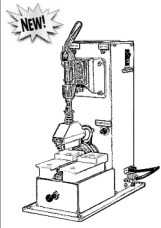

Fusion System Splicer for Aqua-Traxx (Category VIII)

Part Number	Description	Quantity		Carton Weight		Carton Cube		List Price Each
		Bag	Carton	Lbs.	Kilos	Ft.	M.	
Fusion System Splicer for Aqua-Traxx 5/8" & 7/8"								
ZCP9700	Aqua-Traxx Fusion System Splicer	—	1	45.0	20.41	3.67	0.104	6,000.00
ZCP9710	Replacement Teflon (10 per bag)	10	—	—	—	—	—	55.00
ZCP9720	Replacement Heating Element (2 sets) <small>*Note: Includes 2 Lower Insulating Tape, 2 Heating Elements, 2 Upper Teflon Insulating Tape</small>	2	—	—	—	—	—	105.00
ZCP9730	Replacement Heating Blocks (1 unit) <small>*Note: Each Splicer requires two Heating Blocks</small>	1	—	—	—	—	—	215.00

Aqua-Traxx®

with the **PBX Advantage**

Premium Drip Tape with Unmatched Precision

- Emitter spacing options from 4 to 24 inches
- Flow rates that work best for your needs
- Accurately delivers water, fertilizer and chemicals
- Advanced emitter design helps reduce clogging
- Delivers extraordinary performance and durability
- Lower filtration requirement — 140-mesh

Toro Irrigation Solutions

















PRECISE. EFFICIENT. PRACTICAL.

TORO. Count on it.



To order, call Toro Micro-Irrigation
 El Cajon, Ca: +1 (800) 333-8125 or +1 (619) 562-2950
 Sanford, Fl: +1 (800) 806-6582 or +1 (407) 321-2901
 List Prices are US\$. FOB Shipping Point. Effective November 19, 2014 (ALT002)

Drip Tape Fittings















		Pro-Loc™ Tape Fittings (Category VIII)							
Part Number	Description	Quantity		Carton Weight		Carton Cube		List Price Each	
		Bag	Carton	Lbs.	Kilos	Ft.	M.		
Couplings									
	FTC500	5/8" Tape Coupling	50	500	—	—	1.28	0.036	0.48
	FTC700	7/8" Tape Coupling	50	350	—	—	1.28	0.036	0.93
	FTC800	1" Tape Coupling	50	300	—	—	1.28	0.036	1.47
250 Series Barb Adapter									
	FTAS-250B	5/8" Tape x 250 Series Barb Adapter	—	400	—	—	1.28	0.036	0.34
400 Series Barb Coupling									
	FBC400B	400 Series Barb Coupling	500	1500	—	—	1.28	0.036	0.30
400 Series Barb Adapter									
	FTAS-400B	5/8" Tape x 400 Series Barb Adapter	—	400	—	—	1.28	0.036	0.34
700 Series Barb Adapter									
	FTAS-700B	5/8" Tape x 700 Series Barb Adapter	—	400	—	—	1.28	0.036	0.37
	FTA7-700B	7/8" Tape x 700 Series Barb Adapter	—	400	—	—	1.28	0.036	0.79
425 Series Barb Adapter									
	FTAS-425G	5/8" Tape x 425 Series Barb Adapter with Integral Gasket	100	700	—	—	1.28	0.036	0.37
425 Series Barb Adapter with Rubber Grommet									
	FTAS-425GR	5/8" Tape x 425 Series Barb Adapter with Rubber Grommet	100	600	—	—	1.28	0.036	0.54
	FTA7-425GR	7/8" Tape x 425 Series Barb Adapter with Rubber Grommet	100	400	—	—	1.28	0.036	0.86
Top Hat Grommets									
	FTHG4	Top Hat Grommet for 400 - 425 Series Barbs	100	7,000	—	—	1.28	0.036	0.24
Tape End Plugs									
	FTAS-END	5/8" TAPE END PLUG	100	800	—	—	1.28	0.036	0.51
	FTA7-END	7/8" TAPE END PLUG	50	500	—	—	1.28	0.036	0.66
Female Hose Thread Swivel Adapter									
	FTAS-75FHS	5/8" Tape x 3/4" Female Hose Swivel Adapter	—	400	—	—	1.28	0.036	1.25
3/4" Male Adapter									
	FTAS-75MPT	5/8" Tape x 3/4" MPT Male Adapter	100	500	—	—	1.28	0.036	0.42
	FTA7-75MPT	7/8" Tape x 3/4" MPT Male Adapter	50	400	—	—	1.28	0.036	0.62
	FTA8-75MPT	1" Tape x 3/4" MPT Male Adapter	50	300	—	—	1.28	0.036	1.02
Barb Adapters x Flush Valves									
	FTAS-FVL	5/8" Tape x Low Pressure Flush Valve	50	350	—	—	1.28	0.036	1.63
	FTA7-FVL	7/8" Tape x Low Pressure Flush Valve	50	350	—	—	1.28	0.036	1.91
Flush Valves									
	FFVFPT-L	Automatic Flush Valve x 3/4" Female Low Flow - White	100	800	—	—	1.28	0.036	0.88
	FFVFPT-H	Automatic Flush Valve x 3/4" Female High Flow - Red	100	800	—	—	1.28	0.036	0.88
Layflat Takeoff Fittings - Single Grip									
	FTAS-LF	5/8" Tape x Layflat Takeoff - Single Grip	50	400	—	—	1.28	0.036	0.70
	FTA7-LF	7/8" Tape x Layflat Takeoff - Single Grip	100	300	—	—	1.28	0.036	1.07
Layflat Takeoff Fittings - Double Grip									
	FTAS-LF2	5/8" Tape x Layflat Takeoff - Double Grip	50	400	—	—	1.28	0.036	0.94
Tape x Hose Adapter with Locking Nut									
	FTAS-600HN	5/8" Tape x 600 Series Pro-Loc Adapter with Locking Nut	50	500	—	—	1.28	0.036	1.00
Barbed Hose Adapters									
	FTAS-500HB	5/8" Tape x 500 Series Hose Barb Adapter	100	700	—	—	1.28	0.036	0.34
	FTAS-700HB	5/8" Tape x 700 Series Hose Barb Adapter	100	600	—	—	1.28	0.036	0.40
	FTA7-700HB	7/8" Tape x 700 Series Hose Barb Adapter	50	400	—	—	1.28	0.036	0.61

Pro-Loc™ Tape Fittings Feature a Blue Nut for Easy Identification



Drip Tape Fittings

Pro-Loc™ Tape Fittings Cont... (Category VIII)

Part Number	Description	Quantity		Carton Weight		Carton Cube		List Price Each
		Bag	Carton	Lbs.	Kilos	Ft.	M.	
Tape x Tubing Assembly								
 FTAS-CL12B	5/8" Pro-Loc Tapex 400B w/12" tubing assembly	—	550	—	—	1.28	0.036	1.08
FTAS-CL18B	5/8" Pro-Loc Tapex 400B w/18" tubing assembly	—	500	—	—	1.28	0.036	1.15
FTAS-CL24B	5/8" Pro-Loc Tapex 400B w/24" tubing assembly	—	450	—	—	1.28	0.036	1.25
FTAS-CL30B	5/8" Pro-Loc Tapex 400B w/30" tubing assembly	—	400	—	—	1.28	0.036	1.40
Tees								
 FTT500	5/8" Tape Tee	50	200	—	—	1.28	0.036	1.15
FTT700	7/8" Tape Tee	50	150	—	—	1.28	0.036	2.23
Barbed Tees								
 FTT5-500HB	5/8" Tape Tee x 500 Series Hose Barb	50	300	—	—	1.28	0.036	1.50
FTT5-700HB	5/8" Tape Tee x 700 Series Hose Barb	50	300	—	—	1.28	0.036	1.58
Shutoff Valves								
 FTV500	5/8" Tape Shutoff Valve	50	250	—	—	1.28	0.036	1.26
FTV700	7/8" Tape Shutoff Valve	—	400	—	—	1.28	0.036	1.33
250 Series Barb Adapters with Shutoff Valve								
 FTV5-250B	5/8" Tape x 250 Barb Adapter Shutoff Valve	50	350	—	—	1.28	0.036	1.53
FTV7-250B	7/8" Tape x 250 Barb Adapter Shutoff Valve	50	300	—	—	1.28	0.036	1.92
400 Series Barb Adapters with Shutoff Valve								
 FTV5-400B	5/8" Tape x 400 Barb Adapter Shutoff Valve	50	350	—	—	1.28	0.036	1.63
FTV7-400B	7/8" Tape x 400 Barb Adapter Shutoff Valve	50	300	—	—	1.28	0.036	2.03
Barbed Shutoff Valve with Locking Nut								
 FTV5-420BN	5/8" Tape x 420 Series Barb with Locking Nut Shutoff Valve	—	400	—	—	1.28	0.036	1.36
Barbed Shutoff Valve with Locking Nut								
 FTV5-500HN	5/8" Tape x 500 Series Hose Barb with Locking Nut Shutoff Valve	50	300	—	—	1.28	0.036	1.53
FTV5-600HN	5/8" Tape x 600 Series Hose Barb with Locking Nut Shutoff Valve	50	300	—	—	1.28	0.036	1.70
Barbed Shutoff Valves								
 FTV5-500HB	5/8" Tape x 500 Series Hose Barb Shutoff Valve	50	350	—	—	1.28	0.036	0.97
FTV7-500HB	7/8" Tape x 500 Series Hose Barb Shutoff Valve	—	400	—	—	1.28	0.036	1.53
Layflat Takeoff Shutoff Valve								
 FTV5-LF	5/8" Tape x Layflat Takeoff Shutoff Valve	50	200	—	—	1.28	0.036	1.82
FTV7-LF	7/8" Tape x Layflat Takeoff Shutoff Valve	50	200	—	—	1.28	0.036	2.47
Layflat Installation Tools								
 LF-INST	T-Handle Hex Tool for Layflat Installation	25	250	—	—	1.28	0.036	5.40
LF-CUT14	Layflat Cutter - 14mm	1	50	23.33	10.60	1.28	0.036	91.80
LF-CUT16	Layflat Cutter - 16mm	1	50	23.33	10.60	1.28	0.036	91.80
LF-CUT19	Layflat Cutter - 19mm	1	50	23.33	10.60	1.28	0.036	106.00
400 Series Barb Tools								
 INS-400XS	400B Cutting and Inserting Tool - Extra Short	10	80	25.43	11.56	1.28	0.036	29.70
INS-400S	400B Cutting and Inserting Tool - Short	10	80	25.43	11.56	1.28	0.036	29.70
 INS-400AS	400B Cutting and Inserting Tool with Adjustable Tip - Short	10	80	25.43	11.56	1.28	0.036	42.40
INS-400AL	400B Cutting and Inserting Tool with Adjustable Tip - Long	10	80	25.43	11.56	1.28	0.036	42.40
 TIP-400XS	400B Replacement Tip - ExtraShort	27	216	25.43	11.56	1.28	0.036	23.30
TIP-400S	400B Replacement Tip - Short	27	216	25.43	11.56	1.28	0.036	23.30
 TIP-400AS	400B Replacement Adjustable Tip - Short	27	216	25.43	11.56	1.28	0.036	35.30
TIP-400AL	400B Replacement Adjustable Tip - Long	24	192	25.43	11.56	1.28	0.036	35.30

Pro-Loc™ Tape Fittings Feature a Blue Nut for Easy Identification



To order, call Toro Micro-Irrigation
 El Cajon, Ca: +1 (800) 333-8125 or +1 (619) 562-2950
 Sanford, Fl: +1 (800) 806-6582 or +1 (407) 321-2901
 List Prices are US\$. FOB Shipping Point. Effective November 19, 2014 (ALT002)

Drip Tape Accessories

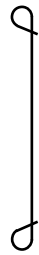

Tape Fitting Accessories (Category VIII)
 ◇ MADE TO ORDER. US\$ 7,500.00 minimum order value will apply. Toro Micro-Irrigation Customer Service will confirm by Fax that the order has been accepted and the estimated date of delivery.

Part Number	Description	Quantity		Carton Weight		Carton Cube		List Price Each
		Bag	Carton	Lbs.	Kilos	Ft.	M.	
Wire Ties & Handles								
FMH08-1	Wire tie handle	1	24	8.0	3.63	0.20	0.006	14.40
FWA01	Stainless steel wire tie, 18 gauge, 6" long	—	5,000	22.0	9.98	0.91	0.026	0.12
FWA02	Galvanized steel wire tie, 18 gauge, 6" long	—	5,000	24.0	10.89	0.64	0.018	0.05
FWA03	Stainless steel wire tie, 18 gauge, 7" long	—	5,000	—	—	—	—	0.10
FWA04	Stainless steel wire tie, 18 gauge, 8" long	—	5,000	—	—	—	—	0.14
FWA05	Galvanized steel wire tie, 16 gauge, 10" long	—	5,000	—	—	—	—	0.13
Hose Punch								
FHP16	Oval hose punch, steel	1	—	—	—	—	—	84.10
Threaded Cap & Washers								
FEP1380	3/4" FHT Cap w/ Washer	100	1,200	12.0	5	1	0.038	0.44
FEP1376	3/4" Washer w/ Screen	—	5,000	25.0	11	2	0.042	0.38
FEP1377	3/4" Washer	—	7,000	22.0	10	1	0.028	0.08

Drip Tape Fittings

Tape Fittings, Ring-Loc™ (Category VIII)



Part Number	Description	Quantity		Carton Weight		Carton Cube		List Price Each
		Bag	Carton	Lbs.	Kilos	Ft.	M.	
Coupling, Tape X Tape Ring-Loc								
FCC98	5/8" Ring-Loc X 5/8" Ring-Loc	100	1,000	23.0	10	1.35	0.038	0.59
Reducer Coupling, Hose (ID) Loc-Eze X Tape Ring-Loc								
FCR1098	10mm Loc-Eze X 5/8" Ring-Loc	100	1,200	22.0	10	1.35	0.038	0.68
FCR1398	13mm Loc-Eze X 5/8" Ring-Loc	100	1,200	22.0	10	1.35	0.038	0.81
FCR1698	16mm Loc-Eze X 5/8" Ring-Loc	100	1,000	24.0	11	1.35	0.038	0.63
Elbow, Tape X Tape Ring-Loc								
FEE98	5/8" Ring-Loc X 5/8" Ring-Loc	100	700	21.0	10	1.35	0.038	1.00
Tee, Tape Ring-Loc X Tape Ring-Loc X Tape Ring-Loc								
FTT98	5/8" X 5/8" X 5/8" Ring-Loc	100	500	22.0	10	1.35	0.038	1.10
Adapter Tee, 3/4" FHT Swivel X Tape Ring-Loc X Tape Ring-Loc								
FTS98	3/4" FHT Swivel w/screen X 5/8" Tape Ring-Loc X 5/8" Tape Ring-Loc	100	400	27.0	12	1.35	0.038	2.4
FTS98-1	3/4" FHT Swivel w/washer X 5/8" Tape Ring-Loc X 5/8" Tape Ring-Loc	100	400	27.0	12	1.35	0.038	2.25
Hose End, 3/4" MHT X Tape Ring-Loc								
FJJ98	3/4" MHT X 5/8" Tape Ring-Loc with cap	100	500	24.0	11	1.35	0.038	1.55
FJA98	3/4" MHT X 5/8" Tape Ring-Loc w/o cap	100	800	23.0	10	1.35	0.038	0.66
FEP1380	3/4" FHT Cap w/ Washer	100	1,200	12.0	5.4	1.35	0.038	0.44
Adapters Coupling, 1/2" MPT X Tape Ring-Loc								
FAM98	1/2" MPT x 5/8" Tape Ring-Loc w/out cap	100	900	21.0	10	1.35	0.038	0.48
Adapter Coupling, 3/4" FHT Swivel X 5/8" Tape Ring-Loc								
FAS98	3/4" FHT Swivel w/screen X 5/8" Tape Ring-Loc	100	700	22.0	10	1.35	0.038	1.92
Hose Connector, Barb X Tape Ring-Loc								
FCA0598	5mm or 6mm Barb X 5/8" Tape Ring-Loc	100	1,500	20.0	9	1.35	0.038	0.62
FCA0798	7mm Barb X 5/8" Tape Ring-Loc	100	1,500	22.0	10	1.35	0.038	0.58
Rubber Grommet, takeoff for PVC X 7mm Barb								
FGP10	Rubber Grommet for 7mm Barb (for use with FCA fittings), use drill bit size 9/16"	—	5,000	22.0	10	0.92	0.026	0.67
Replacement Ring-Loc Rings								
FEP3198	Replacement Ring-Loc for 5/8" Tape fittings	—	6,000	26.0	11.79	1.35	0.038	0.11

Shaded area indicates products being discontinued. Limited to available stocks on hand.



Drip Tape Fittings

Take-off Fittings, Tape Riser Assembly

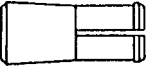
Part Number	Description	Quantity		Carton Weight		Carton Cube		List Price Each
		Box		Lbs.	Kilos	Ft.	M.	
Take-off Adaptors								
	XP-13x13 13 mm grommet inlet x 13mm takeoff	1600		18.0	8.16	—	—	0.59
	XP-13x14 13 mm grommet inlet x 14mm takeoff	1600		22.0	9.98	—	—	0.61
	XP-13x15 13 mm grommet inlet x 15 mm takeoff	1400		21.0	9.53	—	—	0.66
	XP-16x16 16 mm grommet inlet x 16 mm takeoff	1000		18.0	8.16	—	—	0.90
	XP-16x18 16 mm grommet inlet x 18 mm takeoff	1000		22.0	9.98	—	—	0.91
	XP-19x21 19 mm grommet inlet x 21 mm takeoff	800		21.0	9.53	—	—	1.09
	XP-19x25 19 mm grommet inlet x 25 mm takeoff	600		19.0	8.62	—	—	1.45
Rubber Grommets								
	CAP-13 Rubber grommet 13mm	5500		23.0	10.43	—	—	0.54
	CAP-16 Rubber Grommet 16mm	2700		23.0	10.43	—	—	0.68
	CAP-19 Rubber Grommet 19mm	1000		23.0	10.43	—	—	0.79
Wedge Plug								
	FTC10 10mm Wedge Plug, PVC drill size 15/32", poly drill size 29/64", min PVC size 3/4" 20mm	100	5,000	18.0	8,2	1.35	0.038	0.12
	FTC13 13mm Wedge Plug, PVC drill size 19/32", poly drill size 37/64", min PVC size 1" 25mm	100	3,000	18.0	8,2	1.35	0.038	0.21
	FTC16 16mm Wedge Plug, PVC drill size 23/32", poly drill size 45/64", min PVC size 1-1/4" 32mm	100	2,200	18.0	8,2	1.35	0.038	0.42

Flush Valves (Category VI)

Part Number	Description	Quantity		Carton Weight		Carton Cube		List Price Each
		Bag	Carton	Lbs.	Kilos	Ft.	M.	
	FCH-H-FIPT 3/4"FPT, .8 gpm, 2 psi Sealing Pressure, Flush Valve	1	—	—	—	—	—	2.99
	FCH-H-FHT 3/4"FHT, .8 gpm, 2 psi Sealing Pressure, Flush Valve	50	1,200	25	11.3	1.81	0.051	2.99

Ordering Information:

◇ = MADE TO ORDER. Minimum order quantity will apply. Please consult Toro Micro-Irrigation Customer Service for availability.



Count on it.

Aqua-Traxx®

with the **PBX Advantage**



Premium Drip Tape with Unmatched Precision



To order, call Toro Micro-Irrigation
 El Cajon, Ca: +1 (800) 333-8125 or +1 (619) 562-2950
 Sanford, Fl: +1 (800) 806-6582 or +1 (407) 321-2901
 List Prices are US\$. FOB Shipping Point. Effective November 19, 2014 (ALT002)



Flat Emitter Dripline

Flat Emitter Dripline

Flow Rates

Available in 10, 13, and 15 mil wall thickness

Part number	Outlet Spacing		Individual Emitter Flow Rate GPH		Individual Emitter Flow Rate LPH			Q-100 (GPM/ 100 ft)		(LPH/ 1 meter)	
	Inches	cm	@ 8 PSI	@ 10 PSI	@ 0.55 bar	@ 0.7 bar	@ 1 bar	@ 8 PSI	@ 10 PSI	@ 0.55 bar	@ 0.7 bar
0.16 GPH @ 8 PSI											
TWXxx1216	12"	30	0.16	0.18	0.60	0.67	0.80	0.26	0.29	1.96	2.20
TWXxx1416	14"	35	0.16	0.18	0.60	0.67	0.80	0.23	0.25	1.68	1.88
TWXxx1616	16"	40	0.16	0.18	0.60	0.67	0.80	0.20	0.22	1.47	1.65
TWXxx1816	18"	45	0.16	0.18	0.60	0.67	0.80	0.18	0.20	1.31	1.47
TWXxx2016	20"	50	0.16	0.18	0.60	0.67	0.80	0.16	0.18	1.18	1.32
TWXxx2416	24"	60	0.16	0.18	0.60	0.67	0.80	0.13	0.15	0.98	1.10
0.25 GPH @ 8 PSI											
TWXxx1225	12"	30	0.25	0.29	0.95	1.08	1.30	0.42	0.47	3.10	3.54
TWXxx1425	14"	35	0.25	0.29	0.95	1.08	1.30	0.36	0.41	2.66	3.03
TWXxx1625	16"	40	0.25	0.29	0.95	1.08	1.30	0.32	0.36	2.33	2.65
TWXxx1825	18"	45	0.25	0.29	0.95	1.08	1.30	0.28	0.32	2.07	2.36
TWXxx2025	20"	50	0.25	0.29	0.95	1.08	1.30	0.25	0.28	1.86	2.12
TWXxx2425	24"	60	0.25	0.29	0.95	1.08	1.30	0.21	0.24	1.55	1.77
0.30 GPH @ 8 PSI											
TWXxx1230	12"	30	0.30	0.34	1.14	1.27	1.56	0.50	0.57	3.73	4.16
TWXxx1430	14"	35	0.30	0.34	1.14	1.27	1.56	0.43	0.49	3.19	3.57
TWXxx1630	16"	40	0.30	0.34	1.14	1.27	1.56	0.38	0.43	2.79	3.12
TWXxx1830	18"	45	0.30	0.34	1.14	1.27	1.56	0.33	0.38	2.48	2.77
TWXxx2030	20"	50	0.30	0.34	1.14	1.27	1.56	0.30	0.34	2.24	2.50
TWXxx2430	24"	60	0.30	0.34	1.14	1.27	1.56	0.25	0.28	1.86	2.08
0.47 GPH @ 8 PSI											
TWXxx1247	12"	30	0.47	0.53	1.78	1.99	2.40	0.78	0.87	5.84	6.52
TWXxx1447	14"	35	0.47	0.53	1.78	1.99	2.40	0.67	0.75	5.00	5.59
TWXxx1647	16"	40	0.47	0.53	1.78	1.99	2.40	0.59	0.66	4.38	4.89
TWXxx1847	18"	45	0.47	0.53	1.78	1.99	2.40	0.52	0.58	3.89	4.35
TWXxx2047	20"	50	0.47	0.53	1.78	1.99	2.40	0.47	0.52	3.50	3.91
TWXxx2447	24"	60	0.47	0.53	1.78	1.99	2.40	0.39	0.44	2.92	3.26
0.75 GPH @ 8 PSI											
TWXxx1275	12"	30	0.75	0.84	2.83	3.16	3.80	1.24	1.39	9.28	10.37
TWXxx1475	14"	35	0.75	0.84	2.83	3.16	3.80	1.07	1.19	7.95	8.89
TWXxx1675	16"	40	0.75	0.84	2.83	3.16	3.80	0.93	1.04	6.96	7.78
TWXxx1875	18"	45	0.75	0.84	2.83	3.16	3.80	0.83	0.93	6.18	6.91
TWXxx2075	20"	50	0.75	0.84	2.83	3.16	3.80	0.75	0.83	5.57	6.22
TWXxx2475	24"	60	0.75	0.84	2.83	3.16	3.80	0.62	0.70	4.64	5.19

X - denotes 5 for 5/8" diameter, 7 for 7/8" diameter
 xx - denotes mil thickness
 Nominal flow per emitter at 8 PSI

To order, call Toro Micro-Irrigation
 El Cajon, Ca: +1 (800) 333-8125 or +1 (619) 562-2950
 Sanford, Fl: +1 (800) 806-6582 or +1 (407) 321-2901
 List Prices are US\$. FOB Shipping Point. Effective November 19, 2014 (ALT002)





Dripline

BlueLine™ PC (Category II)

Pressure Compensating Dripline with the Blue Stripe® of Quality

◇ **MADE TO ORDER.** 80,000 Ft. minimum order quantity will apply. Toro Micro-Irrigation Customer Service will confirm by fax that the order has been accepted and the estimated date of delivery.
Flow rate expressed gph per individual emitter @ 30 psi (2 Bar)

Part Number	Available Flow Rates	Emitter Spacing	Coil Length		Shipping Weight		Qty per Pallet	Qty per Truck		List Price Per Coil
			Ft.	M.	Lbs.	Kilos.		Pallet	Loose	
0.550" (16mm OD) PC Dripline (0.550" ID x 0.640" OD x 0.045" Wall)										
◇ BP55xxx-12	0.26; 0.42; 0.53; 1.00 gph	12"	1,000	305	38.5	17.5	12	312	560	323.00
◇ BP55xxx-15	0.26; 0.42; 0.53; 1.00 gph	15"	1,000	305	38	17.2	12	312	560	287.00
◇ BP55xxx-18	0.26; 0.42; 0.53; 1.00 gph	18"	1,000	305	37	16.8	12	312	560	263.00
◇ BP55xxx-24	0.26; 0.42; 0.53; 1.00 gph	24"	1,000	305	36	16.3	12	312	560	234.00
◇ BP55xxx-30	0.26; 0.42; 0.53; 1.00 gph	30"	1,000	305	36	16.3	12	312	560	216.00
◇ BP55xxx-36	0.26; 0.42; 0.53; 1.00 gph	36"	1,000	305	35	15.9	12	312	560	204.00
◇ BP55xxx-42	0.26; 0.42; 0.53; 1.00 gph	42"	1,000	305	35	15.9	12	312	560	195.00
◇ BP55xxx-48	0.26; 0.42; 0.53; 1.00 gph	48"	1,000	305	35	15.9	12	312	560	190.00
◇ BP55xxx-54	0.26; 0.42; 0.53; 1.00 gph	54"	1,000	305	35	15.9	12	312	560	184.00
◇ BP55xxx-60	0.26; 0.42; 0.53; 1.00 gph	60"	1,000	305	35	15.9	12	312	560	181.00
◇ BP55xxx-66	0.26; 0.42; 0.53; 1.00 gph	66"	1,000	305	35	15.9	12	312	560	177.00
◇ BP55xxx-72	0.26; 0.42; 0.53; 1.00 gph	72"	1,000	305	35	15.9	12	312	560	175.00



0.620" (18mm OD) PC Dripline (0.620" ID x 0.710" OD x 0.045" Wall)										
◇ BP62xxx-12	0.26; 0.42; 0.53; 1.00 gph	12"	1,000	305	43	19.5	12	312	550	335.00
◇ BP62xxx-15	0.26; 0.42; 0.53; 1.00 gph	15"	1,000	305	42.5	19.3	12	312	550	299.00
◇ BP62xxx-18	0.26; 0.42; 0.53; 1.00 gph	18"	1,000	305	42	19.1	12	312	550	275.00
◇ BP62xxx-24	0.26; 0.42; 0.53; 1.00 gph	24"	1,000	305	41	18.6	12	312	550	245.00
◇ BP62xxx-30	0.26; 0.42; 0.53; 1.00 gph	30"	1,000	305	40	18.1	12	312	550	227.00
◇ BP62xxx-36	0.26; 0.42; 0.53; 1.00 gph	36"	1,000	305	40	18.1	12	312	550	216.00
◇ BP62xxx-42	0.26; 0.42; 0.53; 1.00 gph	42"	1,000	305	39	17.7	12	312	550	207.00
◇ BP62xxx-48	0.26; 0.42; 0.53; 1.00 gph	48"	1,000	305	39	17.7	12	312	550	201.00
◇ BP62xxx-54	0.26; 0.42; 0.53; 1.00 gph	54"	1,000	305	39	17.7	12	312	550	195.00
◇ BP62xxx-60	0.26; 0.42; 0.53; 1.00 gph	60"	1,000	305	39	17.7	12	312	550	192.00
◇ BP62xxx-66	0.26; 0.42; 0.53; 1.00 gph	66"	1,000	305	39	17.7	12	312	550	189.00
◇ BP62xxx-72	0.26; 0.42; 0.53; 1.00 gph	72"	1,000	305	39	17.7	12	312	550	186.00

0.710" (20mm OD) PC Dripline (0.710" ID x 0.805" OD x 0.048" Wall)										
◇ BP71xxx-12	0.26; 0.42; 0.53; 1.00 gph	12"	1,000	305	52	23.6	10	260	400	356.00
◇ BP71xxx-15	0.26; 0.42; 0.53; 1.00 gph	15"	1,000	305	52.5	23.8	10	260	400	320.00
◇ BP71xxx-18	0.26; 0.42; 0.53; 1.00 gph	18"	1,000	305	50	22.7	10	260	400	297.00
◇ BP71xxx-24	0.26; 0.42; 0.53; 1.00 gph	24"	1,000	305	49	22.2	10	260	400	267.00
◇ BP71xxx-30	0.26; 0.42; 0.53; 1.00 gph	30"	1,000	305	48	21.8	10	260	400	250.00
◇ BP71xxx-36	0.26; 0.42; 0.53; 1.00 gph	36"	1,000	305	48	21.8	10	260	400	237.00
◇ BP71xxx-42	0.26; 0.42; 0.53; 1.00 gph	42"	1,000	305	47	21.3	10	260	400	229.00
◇ BP71xxx-48	0.26; 0.42; 0.53; 1.00 gph	48"	1,000	305	47	21.3	10	260	400	223.00
◇ BP71xxx-54	0.26; 0.42; 0.53; 1.00 gph	54"	1,000	305	47	21.3	10	260	400	218.00
◇ BP71xxx-60	0.26; 0.42; 0.53; 1.00 gph	60"	1,000	305	47	21.3	10	260	400	214.00
◇ BP71xxx-66	0.26; 0.42; 0.53; 1.00 gph	66"	1,000	305	47	21.3	10	260	400	210.00
◇ BP71xxx-72	0.26; 0.42; 0.53; 1.00 gph	72"	1,000	305	47	21.3	10	260	400	208.00

xxx Denotes emitter flow rate in gph at 30psi. Substitute xxx, with the flow rate required.

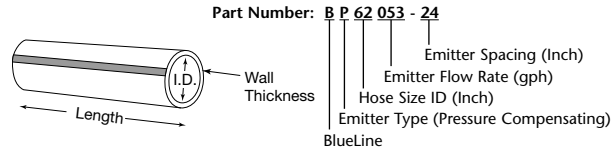

Ordering Information:

- BlueLine hose is manufactured I.D. controlled.
- BlueLine 0.620" ID (18mm OD) is compatible with 0.620" (16mm) ID Loc Eze Fittings. Please refer to Hose Fittings Section.
- BlueLine hose is equivalent to:
 - BlueLine 0.550" ID (16mm OD) EHD1443 Blue Stripe® Round Hose
 - BlueLine 0.620" ID (18mm OD) EHD1643 Blue Stripe® Round Hose
 - BlueLine 0.710" ID (20mm OD) EHD1845 Blue Stripe® Round Hose

Dripline



BlueLine™ PC (Metric) (Category II)
Pressure Compensating Dripline with the Blue Stripe® of Quality

◇ **MADE TO ORDER.** 24,350 Mtr. 80,000 Ft. minimum order quantity will apply. Toro Micro-Irrigation Customer Service will confirm by fax that the order has been accepted and the estimated date of delivery.
Flow rate expressed gph per individual emitter @ 2 Bar (30 psi)

Part Number	Available Flow Rates	Emitter Spacing	Coil Length		Shipping Weight		Qty per Container		List Price Per Coil
			Ft.	M.	Lbs.	Kilos.	20 Ft.	40Ft.	
16mm OD PC Dripline (13.97mm ID x 16.26mm OD x 1.14mm Wall)									
◇ BP16xx-30CM-400	1,0; 1,5; 2,0; 4,0 lph	30cm	1,310	400	50.5	22.9	160	320	429.00
◇ BP16xx-40CM-400	1,0; 1,5; 2,0; 4,0 lph	40cm	1,310	400	49	22.2	160	320	368.00
◇ BP16xx-50CM-400	1,0; 1,5; 2,0; 4,0 lph	50cm	1,310	400	48	21.8	160	320	331.00
◇ BP16xx-60CM-400	1,0; 1,5; 2,0; 4,0 lph	60cm	1,310	400	47.5	21.5	160	320	309.00
◇ BP16xx-75CM-400	1,0; 1,5; 2,0; 4,0 lph	75cm	1,310	400	47	21.3	160	320	285.00
◇ BP16xx-80CM-400	1,0; 1,5; 2,0; 4,0 lph	80cm	1,310	400	47	21.3	160	320	278.00
◇ BP16xx-90CM-400	1,0; 1,5; 2,0; 4,0 lph	90cm	1,310	400	46.5	21.1	160	320	269.00
◇ BP16xx-100CM-400	1,0; 1,5; 2,0; 4,0 lph	100cm	1,310	400	46	20.9	160	320	261.00
◇ BP16xx-120CM-400	1,0; 1,5; 2,0; 4,0 lph	120cm	1,310	400	46	20.9	160	320	249.00
◇ BP16xx-150CM-400	1,0; 1,5; 2,0; 4,0 lph	150cm	1,310	400	46	20.9	160	320	237.00
◇ BP16xx-200CM-400	1,0; 1,5; 2,0; 4,0 lph	200cm	1,310	400	46	20.9	160	320	225.00
16mm OD PC Dripline (13.97mm ID x 16.26mm OD x 0.9mm Wall)									
◇ BP1609xx-30C-400	1,0; 1,5; 2,0; 4,0 lph	30cm	1,310	400	43.0	19.5	180	360	382.00
◇ BP1609xx-40C-400	1,0; 1,5; 2,0; 4,0 lph	40cm	1,310	400	41.5	18.8	180	360	327.00
◇ BP1609xx-50C-400	1,0; 1,5; 2,0; 4,0 lph	50cm	1,310	400	40.5	18.4	180	360	294.00
◇ BP1609xx-60C-400	1,0; 1,5; 2,0; 4,0 lph	60cm	1,310	400	40.0	18.1	180	360	273.00
◇ BP1609xx-75C-400	1,0; 1,5; 2,0; 4,0 lph	75cm	1,310	400	39.5	17.9	180	360	251.00
◇ BP1609xx-80C-400	1,0; 1,5; 2,0; 4,0 lph	80cm	1,310	400	39.5	17.9	180	360	245.00
◇ BP1609xx-90C-400	1,0; 1,5; 2,0; 4,0 lph	90cm	1,310	400	39.0	17.7	180	360	236.00
◇ BP1609xx-100C-400	1,0; 1,5; 2,0; 4,0 lph	100cm	1,310	400	38.5	17.5	180	360	229.00
◇ BP1609xx-120C-400	1,0; 1,5; 2,0; 4,0 lph	120cm	1,310	400	38.5	17.5	180	360	218.00
◇ BP1609xx-150C-400	1,0; 1,5; 2,0; 4,0 lph	150cm	1,310	400	38.5	17.5	180	360	207.00
◇ BP1609xx-200C-400	1,0; 1,5; 2,0; 4,0 lph	200cm	1,310	400	38.5	17.5	180	360	196.00
18mm OD PC Dripline (15.75mm ID x 18.03mm OD x 1.14mm Wall)									
◇ BP18xx-30CM-350	1,0; 1,5; 2,0; 4,0 lph	30cm	1,150	350	50	22.7	150	300	388.00
◇ BP18xx-40CM-350	1,0; 1,5; 2,0; 4,0 lph	40cm	1,150	350	48	21.8	150	300	335.00
◇ BP18xx-50CM-350	1,0; 1,5; 2,0; 4,0 lph	50cm	1,150	350	47	21.3	150	300	303.00
◇ BP18xx-60CM-350	1,0; 1,5; 2,0; 4,0 lph	60cm	1,150	350	47	21.3	150	300	284.00
◇ BP18xx-75CM-350	1,0; 1,5; 2,0; 4,0 lph	75cm	1,150	350	46	20.9	150	300	262.00
◇ BP18xx-80CM-350	1,0; 1,5; 2,0; 4,0 lph	80cm	1,150	350	46	20.9	150	300	257.00
◇ BP18xx-90CM-350	1,0; 1,5; 2,0; 4,0 lph	90cm	1,150	350	46	20.9	150	300	249.00
◇ BP18xx-100CM-350	1,0; 1,5; 2,0; 4,0 lph	100cm	1,150	350	45	20.4	150	300	242.00
◇ BP18xx-120CM-350	1,0; 1,5; 2,0; 4,0 lph	120cm	1,150	350	45	20.4	150	300	231.00
◇ BP18xx-150CM-350	1,0; 1,5; 2,0; 4,0 lph	150cm	1,150	350	45	20.4	150	300	220.00
◇ BP18xx-200CM-350	1,0; 1,5; 2,0; 4,0 lph	200cm	1,150	350	45	20.4	150	300	210.00
20mm OD PC Dripline (18.03mm ID x 20.46mm OD x 1.20mm Wall)									
◇ BP20xx-30CM-305	1,0; 1,5; 2,0; 4,0 lph	30cm	1,000	305	52	23.6	135	275	361.00
◇ BP20xx-40CM-305	1,0; 1,5; 2,0; 4,0 lph	40cm	1,000	305	50	22.7	135	275	314.00
◇ BP20xx-50CM-305	1,0; 1,5; 2,0; 4,0 lph	50cm	1,000	305	49	22.2	135	275	286.00
◇ BP20xx-60CM-305	1,0; 1,5; 2,0; 4,0 lph	60cm	1,000	305	48	21.8	135	275	269.00
◇ BP20xx-75CM-305	1,0; 1,5; 2,0; 4,0 lph	75cm	1,000	305	48	21.8	135	275	251.00
◇ BP20xx-80CM-305	1,0; 1,5; 2,0; 4,0 lph	80cm	1,000	305	47	21.3	135	275	246.00
◇ BP20xx-90CM-305	1,0; 1,5; 2,0; 4,0 lph	90cm	1,000	305	47	21.3	135	275	238.00
◇ BP20xx-100CM-305	1,0; 1,5; 2,0; 4,0 lph	100cm	1,000	305	47	21.3	135	275	233.00
◇ BP20xx-120CM-305	1,0; 1,5; 2,0; 4,0 lph	120cm	1,000	305	47	21.3	135	275	224.00
◇ BP20xx-150CM-305	1,0; 1,5; 2,0; 4,0 lph	150cm	1,000	305	47	21.3	135	275	215.00
◇ BP20xx-200CM-305	1,0; 1,5; 2,0; 4,0 lph	200cm	1,000	305	47	21.3	135	275	206.00

xx Denotes emitter flow rate in lph at 2 bar. Substitute xx, with the flow rate required.

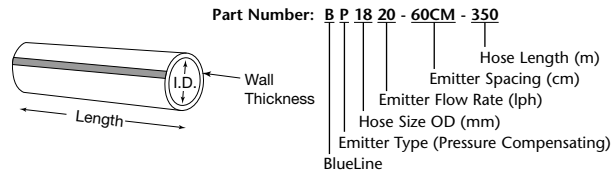

Part Number: **B P 18 20 - 60CM - 350**

Ordering Information:

- BlueLine hose is manufactured I.D. controlled.
- BlueLine 0.620" ID (18mm OD) is compatible with 0.620" (16mm) ID Loc Eze Fittings. Please refer to Hose Fittings Section.
- BlueLine hose is equivalent to:
 - BlueLine 0.550" ID (16mm OD) EHD1443 Blue Stripe® Round Hose
 - BlueLine 0.620" ID (18mm OD) EHD1643 Blue Stripe® Round Hose
 - BlueLine 0.710" ID (20mm OD) EHD1845 Blue Stripe® Round Hose



To order, call Toro Micro-Irrigation
 El Cajon, Ca: +1 (800) 333-8125 or +1 (619) 562-2950
 Sanford, Fl: +1 (800) 806-6582 or +1 (407) 321-2901
 List Prices are US\$. FOB Shipping Point. Effective November 19, 2014 (ALT002)

Dripline

BlueLine® Classic
Premium Dripline

BlueLine™ Classic™ (Category II)

Non-Pressure Compensating Dripline with the Blue Stripe® of Quality

◇ **MADE TO ORDER.** 80,000 Ft. minimum order quantity will apply. Toro Micro-Irrigation Customer Service will confirm by fax that the order has been accepted and the estimated date of delivery.

Flow rate expressed gph per individual emitter @ 15 psi (1 Bar)

Part Number	Available Flow Rates	Emitter Spacing	Coil Length		Shipping Weight		Qty per Pallet	Qty per Truck		List Price Per Coil
			Ft.	M.	Lbs.	Kilos.		Pallet	Loose	
0.550" (16mm OD) Classic Dripline (0.550" ID x 0.640" OD x 0.045" Wall)										
◇ BC55xxx-12	0.53 ; 1.00 gph	12"	1,000	305	43	19.5	12	312	560	183.00
◇ BC55xxx-15	0.53 ; 1.00 gph	15"	1,000	305	43	19.0	12	312	560	177.00
◇ BC55xxx-18	0.53 ; 1.00 gph	18"	1,000	305	40	18.1	12	312	560	168.00
◇ BC55xxx-24	0.53 ; 1.00 gph	24"	1,000	305	39	17.7	12	312	560	163.00
◇ BC55xxx-30	0.53 ; 1.00 gph	30"	1,000	305	38	17.2	12	312	560	159.00
◇ BC55xxx-36	0.53 ; 1.00 gph	36"	1,000	305	37	16.8	12	312	560	158.00
◇ BC55xxx-42	0.53 ; 1.00 gph	42"	1,000	305	36.5	16.6	12	312	560	153.00
◇ BC55xxx-48	0.53 ; 1.00 gph	48"	1,000	305	36	16.3	12	312	560	152.00
◇ BC55xxx-54	0.53 ; 1.00 gph	54"	1,000	305	36	16.3	12	312	560	151.50
◇ BC55xxx-60	0.53 ; 1.00 gph	60"	1,000	305	36	16.3	12	312	560	151.00
◇ BC55xxx-66	0.53 ; 1.00 gph	66"	1,000	305	36	16.3	12	312	560	150.00
◇ BC55xxx-72	0.53 ; 1.00 gph	72"	1,000	305	36	16.3	12	312	560	149.00
0.620" (18mm OD) Classic Dripline (0.620" ID x 0.710" OD x 0.045" Wall)										
◇ BC62xxx-12	0.53 ; 1.00 gph	12"	1,000	305	50	22.7	12	312	550	194.00
◇ BC62xxx-15	0.53 ; 1.00 gph	15"	1,000	305	49	22.2	12	312	550	186.00
◇ BC62xxx-18	0.53 ; 1.00 gph	18"	1,000	305	46	20.9	12	312	550	181.00
◇ BC62xxx-24	0.53 ; 1.00 gph	24"	1,000	305	44	20.0	12	312	550	174.00
◇ BC62xxx-30	0.53 ; 1.00 gph	30"	1,000	305	43	19.5	12	312	550	168.00
◇ BC62xxx-36	0.53 ; 1.00 gph	36"	1,000	305	42	19.1	12	312	550	166.00
◇ BC62xxx-42	0.53 ; 1.00 gph	42"	1,000	305	41	18.6	12	312	550	164.00
◇ BC62xxx-48	0.53 ; 1.00 gph	48"	1,000	305	41	18.6	12	312	550	163.00
◇ BC62xxx-54	0.53 ; 1.00 gph	54"	1,000	305	40.5	18.4	12	312	550	162.00
◇ BC62xxx-60	0.53 ; 1.00 gph	60"	1,000	305	40	18.1	12	312	550	161.00
◇ BC62xxx-66	0.53 ; 1.00 gph	66"	1,000	305	40	18.1	12	312	550	160.00
◇ BC62xxx-72	0.53 ; 1.00 gph	72"	1,000	305	40	18.1	12	312	550	159.00
0.710" (20mm OD) Classic Dripline (0.710" ID x 0.805" OD x 0.048" Wall)										
◇ BC71xxx-12	0.53 ; 1.00 gph	12"	1,000	305	56.5	25.6	10	260	400	217.00
◇ BC71xxx-15	0.53 ; 1.00 gph	15"	1,000	305	56.5	25.0	10	260	400	209.00
◇ BC71xxx-18	0.53 ; 1.00 gph	18"	1,000	305	53	24.0	10	260	400	203.00
◇ BC71xxx-24	0.53 ; 1.00 gph	24"	1,000	305	51	23.1	10	260	400	197.00
◇ BC71xxx-30	0.53 ; 1.00 gph	30"	1,000	305	50	22.7	10	260	400	192.00
◇ BC71xxx-36	0.53 ; 1.00 gph	36"	1,000	305	49	22.2	10	260	400	190.00
◇ BC71xxx-42	0.53 ; 1.00 gph	42"	1,000	305	49	22.2	10	260	400	187.00
◇ BC71xxx-48	0.53 ; 1.00 gph	48"	1,000	305	48	21.8	10	260	400	186.00
◇ BC71xxx-54	0.53 ; 1.00 gph	54"	1,000	305	48	21.8	10	260	400	185.00
◇ BC71xxx-60	0.53 ; 1.00 gph	60"	1,000	305	48	21.8	10	260	400	184.50
◇ BC71xxx-66	0.53 ; 1.00 gph	66"	1,000	305	48	21.8	10	260	400	184.00
◇ BC71xxx-72	0.53 ; 1.00 gph	72"	1,000	305	48	21.8	10	260	400	183.00

xxx Denotes emitter flow rate in gph at 15psi. Substitute xxx, with the flow rate required.

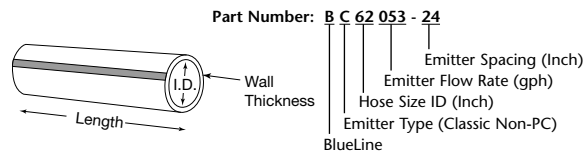

Ordering Information:

- BlueLine hose is manufactured I.D. controlled.
- BlueLine 0.620" ID (18mm OD) is compatible with 0.620" (16mm) ID Loc Eze Fittings. Please refer to Hose Fittings Section.
- BlueLine hose is equivalent to:
 - BlueLine 0.550" ID (16mm OD) EHD1443 Blue Stripe® Round Hose
 - BlueLine 0.620" ID (18mm OD) EHD1643 Blue Stripe® Round Hose
 - BlueLine 0.710" ID (20mm OD) EHD1845 Blue Stripe® Round Hose



Dripline

BlueLine® Classic
Premium Dripline

BlueLine™ Classic™ (Metric) (Category II)

Non-Pressure Compensating Dripline with the Blue Stripe® of Quality

◇ **MADE TO ORDER.** 24,350 Mtr. (80,000 Ft.) minimum order quantity will apply. Toro Micro-Irrigation Customer Service will confirm by fax that the order has been accepted and the estimated date of delivery.
Flow rate expressed lph per individual emitter @ 1 Bar (15 psi)

Part Number	Available Flow Rates	Emitter Spacing	Coil Length		Shipping Weight		Coils per Container		List Price Per Coil
			Ft.	M.	Lbs.	Kilos.	20 Ft.	40Ft.	
16mm OD Classic Dripline (13.97mm ID x 16.26mm OD x 1.14mm Wall)									
◇ BC16xx-30CM-400	2,0 ; 4,0 lph	30cm	1,310	400	56	25.4	160	320	241.00
◇ BC16xx-40CM-400	2,0 ; 4,0 lph	40cm	1,310	400	54	24.5	160	320	226.00
◇ BC16xx-50CM-400	2,0 ; 4,0 lph	50cm	1,310	400	51.5	23.4	160	320	218.00
◇ BC16xx-60CM-400	2,0 ; 4,0 lph	60cm	1,310	400	50.5	22.9	160	320	212.00
◇ BC16xx-75CM-400	2,0 ; 4,0 lph	75cm	1,310	400	49	22.2	160	320	208.00
◇ BC16xx-80CM-400	2,0 ; 4,0 lph	80cm	1,310	400	49	22.2	160	320	206.00
◇ BC16xx-90CM-400	2,0 ; 4,0 lph	90cm	1,310	400	48.5	22.0	160	320	204.00
◇ BC16xx-100CM-400	2,0 ; 4,0 lph	100cm	1,310	400	48	21.8	160	320	202.00
◇ BC16xx-120CM-400	2,0 ; 4,0 lph	120cm	1,310	400	47.5	21.5	160	320	198.00
◇ BC16xx-150CM-400	2,0 ; 4,0 lph	150cm	1,310	400	47	21.3	160	320	195.00
◇ BC16xx-200CM-400	2,0 ; 4,0 lph	200cm	1,310	400	47	21.3	160	320	192.00

18mm OD Classic Dripline (15.75mm ID x 18.03mm OD x 1.14mm Wall)

◇ BC18xx-30CM-350	2,0 ; 4,0 lph	30cm	1,150	350	57	25.9	150	300	224.00
◇ BC18xx-40CM-350	2,0 ; 4,0 lph	40cm	1,150	350	54	24.5	150	300	211.00
◇ BC18xx-50CM-350	2,0 ; 4,0 lph	50cm	1,150	350	52	23.6	150	300	204.00
◇ BC18xx-60CM-350	2,0 ; 4,0 lph	60cm	1,150	350	50	22.7	150	300	198.00
◇ BC18xx-75CM-350	2,0 ; 4,0 lph	75cm	1,150	350	49	22.2	150	300	194.00
◇ BC18xx-80CM-350	2,0 ; 4,0 lph	80cm	1,150	350	49	22.2	150	300	192.00
◇ BC18xx-90CM-350	2,0 ; 4,0 lph	90cm	1,150	350	48	21.8	150	300	191.00
◇ BC18xx-100CM-350	2,0 ; 4,0 lph	100cm	1,150	350	48	21.8	150	300	189.00
◇ BC18xx-120CM-350	2,0 ; 4,0 lph	120cm	1,150	350	47	21.3	150	300	187.00
◇ BC18xx-150CM-350	2,0 ; 4,0 lph	150cm	1,150	350	46	20.9	150	300	184.00
◇ BC18xx-200CM-350	2,0 ; 4,0 lph	200cm	1,150	350	46	20.9	150	300	182.00

20mm OD Classic Dripline (18.03mm ID x 20.46mm OD x 1.20mm Wall)

◇ BC20xx-30CM-305	2,0 ; 4,0 lph	30cm	1,000	305	56.5	25.6	135	275	218.00
◇ BC20xx-40CM-305	2,0 ; 4,0 lph	40cm	1,000	305	54	24.5	135	275	208.00
◇ BC20xx-50CM-305	2,0 ; 4,0 lph	50cm	1,000	305	52	23.6	135	275	202.00
◇ BC20xx-60CM-305	2,0 ; 4,0 lph	60cm	1,000	305	51	23.1	135	275	197.00
◇ BC20xx-75CM-305	2,0 ; 4,0 lph	75cm	1,000	305	50	22.7	135	275	192.00
◇ BC20xx-80CM-305	2,0 ; 4,0 lph	80cm	1,000	305	50	22.7	135	275	191.00
◇ BC20xx-90CM-305	2,0 ; 4,0 lph	90cm	1,000	305	49	22.2	135	275	190.00
◇ BC20xx-100CM-305	2,0 ; 4,0 lph	100cm	1,000	305	49	22.2	135	275	189.00
◇ BC20xx-120CM-305	2,0 ; 4,0 lph	120cm	1,000	305	48	21.8	135	275	186.00
◇ BC20xx-150CM-305	2,0 ; 4,0 lph	150cm	1,000	305	48	21.8	135	275	184.00
◇ BC20xx-200CM-305	2,0 ; 4,0 lph	200cm	1,000	305	48	21.8	135	275	182.00

xx Denotes emitter flow rate in lph at 1 bar. Substitute xx, with the flow rate required.

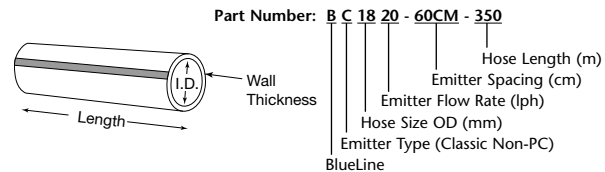

Ordering Information:

- BlueLine hose is manufactured I.D. controlled.
- BlueLine 0.620" ID (18mm OD) is compatible with 0.620" (16mm) ID Loc Eze Fittings. Please refer to Hose Fittings Section.
- BlueLine hose is equivalent to:

BlueLine 0.550" ID (16mm OD)	EHD1443	Blue Stripe® Round Hose
BlueLine 0.620" ID (18mm OD)	EHD1643	Blue Stripe® Round Hose
BlueLine 0.710" ID (20mm OD)	EHD1845	Blue Stripe® Round Hose



To order, call Toro Micro-Irrigation
 El Cajon, Ca: +1 (800) 333-8125 or +1 (619) 562-2950
 Sanford, Fl: +1 (800) 806-6582 or +1 (407) 321-2901
 List Prices are US\$. FOB Shipping Point. Effective November 19, 2014 (ALT002)

Dripline

BlueLine™ Clipperline™

BlueLine™ PC Clipperline™ (Category II)

Pressure Compensating Dripline with Clips

◇ **MADE TO ORDER.** 80,000 Ft. minimum order quantity will apply. Toro Micro-Irrigation Customer Service will confirm by fax that the order has been accepted and the estimated date of delivery.
Flow rate expressed gph per individual emitter @ 30 psi (2 Bar)



Part Number	Available Flow Rates	Emitter Spacing	Coil Length		Shipping Weight		Coils per Pallet	Coils per Truck		List Price Per Coil
			Ft.	M.	Lbs.	Kilos.		Pallet	Loose	
0.620" (18mm OD) PC Clipperline™ (0.620" ID x 0.710" OD x 0.045" Wall)										
◇ BP62xxx-18C	.26, .42, .53, 1.0 gph	18"	1,000	305	43	19.5	10	260	490	364.00
◇ BP62xxx-24C	.26, .42, .53, 1.0 gph	24"	1,000	305	43	19.5	10	260	490	300.00
◇ BP62xxx-30C	.26, .42, .53, 1.0 gph	30"	1,000	305	41	18.6	10	260	490	262.00
◇ BP62xxx-36C	.26, .42, .53, 1.0 gph	36"	1,000	305	41	18.6	10	260	490	236.00
◇ BP62xxx-42C	.26, .42, .53, 1.0 gph	42"	1,000	305	40	18.1	10	260	490	220.00
◇ BP62xxx-48C	.26, .42, .53, 1.0 gph	48"	1,000	305	40	18.1	10	260	490	212.00
◇ BP62xxx-54C	.26, .42, .53, 1.0 gph	54"	1,000	305	40	18.1	10	260	490	207.00
◇ BP62xxx-60C	.26, .42, .53, 1.0 gph	60"	1,000	305	40	18.1	10	260	490	201.00
0.710" (20mm OD) PC Clipperline™ (0.710" ID x 0.805" OD x 0.048" Wall)										
◇ BP71xxx-18C	.26, .42, .53, 1.0 gph	18"	1,000	305	51	23.1	10	260	340	386.00
◇ BP71xxx-24C	.26, .42, .53, 1.0 gph	24"	1,000	305	51	23.1	10	260	340	322.00
◇ BP71xxx-30C	.26, .42, .53, 1.0 gph	30"	1,000	305	49	22.2	10	260	340	284.00
◇ BP71xxx-36C	.26, .42, .53, 1.0 gph	36"	1,000	305	49	22.2	10	260	340	259.00
◇ BP71xxx-42C	.26, .42, .53, 1.0 gph	42"	1,000	305	48	21.8	10	260	340	243.00
◇ BP71xxx-48C	.26, .42, .53, 1.0 gph	48"	1,000	305	48	21.8	10	260	340	235.00
◇ BP71xxx-54C	.26, .42, .53, 1.0 gph	54"	1,000	305	48	21.8	10	260	340	228.00
◇ BP71xxx-60C	.26, .42, .53, 1.0 gph	60"	1,000	305	48	21.8	10	260	340	224.00

xx Denotes emitter flow rate in gph at 30psi. Substitute xx, with the flow rate required.

BlueLine™ Classic® Clipperline™ (Category II)

Non-Pressure Compensating Dripline with Clips

◇ **MADE TO ORDER.** 80,000 Ft. minimum order quantity will apply. Toro Micro-Irrigation Customer Service will confirm by fax that the order has been accepted and the estimated date of delivery.
Flow rate expressed gph per individual emitter @ 15 psi (1 Bar)



Part Number	Available Flow Rates	Emitter Spacing	Coil Length		Shipping Weight		Coils per Pallet	Coils per Truck		List Price Per Coil
			Ft.	M.	Lbs.	Kilos.		Pallet	Loose	
0.620" (18mm OD) Classic Clipperline™ (0.620" ID x 0.710" OD x 0.045" Wall)										
◇ BC62xxx-18C	.53, 1.0 gph	18"	1,000	305	46	20.9	10	260	490	267.00
◇ BC62xxx-24C	.53, 1.0 gph	24"	1,000	305	46	20.9	10	260	490	228.00
◇ BC62xxx-30C	.53, 1.0 gph	30"	1,000	305	44	20.0	10	260	490	204.00
◇ BC62xxx-36C	.53, 1.0 gph	36"	1,000	305	43	19.5	10	260	490	190.00
◇ BC62xxx-42C	.53, 1.0 gph	42"	1,000	305	42	19.1	10	260	490	180.00
◇ BC62xxx-48C	.53, 1.0 gph	48"	1,000	305	42	19.1	10	260	490	176.00
◇ BC62xxx-54C	.53, 1.0 gph	54"	1,000	305	41	18.6	10	260	490	174.00
◇ BC62xxx-60C	.53, 1.0 gph	60"	1,000	305	41	18.6	10	260	490	173.00
0.710" (20mm OD) Classic Clipperline™ (0.710" ID x 0.805" OD x 0.048" Wall)										
◇ BC71xxx-18C	.53, 1.0 gph	18"	1,000	305	53	24.0	10	260	340	289.00
◇ BC71xxx-24C	.53, 1.0 gph	24"	1,000	305	53	24.0	10	260	340	250.00
◇ BC71xxx-30C	.53, 1.0 gph	30"	1,000	305	51	23.1	10	260	340	226.00
◇ BC71xxx-36C	.53, 1.0 gph	36"	1,000	305	50	22.7	10	260	340	210.00
◇ BC71xxx-42C	.53, 1.0 gph	42"	1,000	305	50	22.7	10	260	340	201.00
◇ BC71xxx-48C	.53, 1.0 gph	48"	1,000	305	49	22.2	10	260	340	199.00
◇ BC71xxx-54C	.53, 1.0 gph	54"	1,000	305	49	22.2	10	260	340	197.00
◇ BC71xxx-60C	.53, 1.0 gph	60"	1,000	305	49	22.2	10	260	340	194.00

xx Denotes emitter flow rate in gph at 15psi. Substitute xx, with the flow rate required.

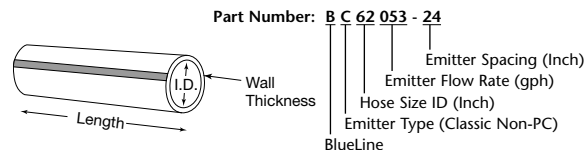

Ordering Information:

- Clips are pre-installed one per emitter, unless otherwise requested!
- BlueLine hose is manufactured I.D. controlled.
- BlueLine 0.620" ID (18mm OD) is compatible with 0.620" (16mm) ID Loc Eze Fittings. Please refer to Hose Fittings Section.
- BlueLine hose is equivalent to:
 - BlueLine 0.550" ID (16mm OD) EHD1443 Blue Stripe® Round Hose
 - BlueLine 0.620" ID (18mm OD) EHD1643 Blue Stripe® Round Hose
 - BlueLine 0.710" ID (20mm OD) EHD1845 Blue Stripe® Round Hose

To order, call Toro Micro-Irrigation
 El Cajon, Ca: +1 (800) 333-8125 or +1 (619) 562-2950
 Sanford, Fl: +1 (800) 806-6582 or +1 (407) 321-2901
 List Prices are US\$. FOB Shipping Point. Effective November 19, 2014 (ALT002)



Dripline



Drip In® PC (Category II)
 Pressure Compensating Dripline with the Blue Stripe® of Quality

◇ **MADE TO ORDER.** 20,000 Ft. minimum order quantity will apply. Toro Micro-Irrigation Customer Service will confirm by fax that the order has been accepted and the estimated date of delivery.
 Flow rate expressed gph per individual emitter @ 30 psi (2 Bar)

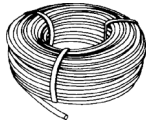

Part Number	Available Flow Rates	Emitter Spacing	Coil Length		Shipping Weight		Coils per Pallet	Coils per Truck		List Price Per Coil
			Ft.	M.	Lbs.	Kilos.		Pallet	Loose	
0.550" (16mm OD) PC Dripline (0.550" ID x 0.640" OD x 0.045" Wall)										
◇ PCS16xx-12	0.53, 1.00 gph	12"	1,000	305	38.5	17.5	16	416	650	393.00
◇ PCS16xx-15	0.53, 1.00 gph	15"	1,000	305	38	17.2	16	416	650	364.00
◇ PCS16xx-18	0.53, 1.00 gph	18"	1,000	305	37	16.8	16	416	650	318.00
◇ PCS16xx-24	0.53, 1.00 gph	24"	1,000	305	36	16.3	16	416	650	294.00
◇ PCS16xx-30	0.53, 1.00 gph	30"	1,000	305	36	16.3	16	416	650	260.00
◇ PCS16xx-36	0.53, 1.00 gph	36"	1,000	305	35	15.9	16	416	650	251.00
◇ PCS16xx-42	0.53, 1.00 gph	42"	1,000	305	35	15.9	16	416	650	244.00
◇ PCS16xx-48	0.53, 1.00 gph	48"	1,000	305	35	15.9	16	416	650	238.00
◇ PCS16xx-54	0.53, 1.00 gph	54"	1,000	305	35	15.9	16	416	650	235.00
◇ PCS16xx-60	0.53, 1.00 gph	60"	1,000	305	35	15.9	16	416	650	232.00
◇ PCS16xx-66	0.53, 1.00 gph	66"	1,000	305	35	15.9	16	416	650	229.00
◇ PCS16xx-72	0.53, 1.00 gph	72"	1,000	305	35	15.9	16	416	650	227.00
0.620" (18mm OD) PC Dripline (0.620" ID x 0.710" OD x 0.045" Wall)										
◇ PCS18xx-12	0.53, 1.00 gph	12"	1,000	305	43	19.5	10	260	475	406.00
◇ PCS18xx-15	0.53, 1.00 gph	15"	1,000	305	42.5	19.3	10	260	475	377.00
◇ PCS18xx-18	0.53, 1.00 gph	18"	1,000	305	42	19.1	10	260	475	331.00
◇ PCS18xx-24	0.53, 1.00 gph	24"	1,000	305	41	18.6	10	260	475	294.00
◇ PCS18xx-30	0.53, 1.00 gph	30"	1,000	305	40	18.1	10	260	475	277.00
◇ PCS18xx-36	0.53, 1.00 gph	36"	1,000	305	40	18.1	10	260	475	267.00
◇ PCS18xx-42	0.53, 1.00 gph	42"	1,000	305	39	17.7	10	260	475	260.00
◇ PCS18xx-48	0.53, 1.00 gph	48"	1,000	305	39	17.7	10	260	475	254.00
◇ PCS18xx-54	0.53, 1.00 gph	54"	1,000	305	39	17.7	10	260	475	251.00
◇ PCS18xx-60	0.53, 1.00 gph	60"	1,000	305	39	17.7	10	260	475	246.00
◇ PCS18xx-66	0.53, 1.00 gph	66"	1,000	305	39	17.7	10	260	475	245.00
◇ PCS18xx-72	0.53, 1.00 gph	72"	1,000	305	39	17.7	10	260	475	243.00
0.710" (20mm OD) PC Dripline (0.710" ID x 0.805" OD x 0.048" Wall)										
◇ PCS20xx-12	0.53, 1.00 gph	12"	1,000	305	52	23.6	10	260	380	428.00
◇ PCS20xx-15	0.53, 1.00 gph	15"	1,000	305	52	23.6	10	260	380	398.00
◇ PCS20xx-18	0.53, 1.00 gph	18"	1,000	305	50	22.7	10	260	380	338.00
◇ PCS20xx-24	0.53, 1.00 gph	24"	1,000	305	49	22.2	10	260	380	326.00
◇ PCS20xx-30	0.53, 1.00 gph	30"	1,000	305	48	21.8	10	260	380	306.00
◇ PCS20xx-36	0.53, 1.00 gph	36"	1,000	305	48	21.8	10	260	380	295.00
◇ PCS20xx-42	0.53, 1.00 gph	42"	1,000	305	47	21.3	10	260	380	289.00
◇ PCS20xx-48	0.53, 1.00 gph	48"	1,000	305	47	21.3	10	260	380	284.00
◇ PCS20xx-54	0.53, 1.00 gph	54"	1,000	305	47	21.3	10	260	380	279.00
◇ PCS20xx-60	0.53, 1.00 gph	60"	1,000	305	47	21.3	10	260	380	277.00
◇ PCS20xx-66	0.53, 1.00 gph	66"	1,000	305	47	21.3	10	260	380	274.00
◇ PCS20xx-72	0.53, 1.00 gph	72"	1,000	305	47	21.3	10	260	380	272.00

xx Denotes emitter flow rate in gph at 30psi. Substitute xx, with the flow rate required.

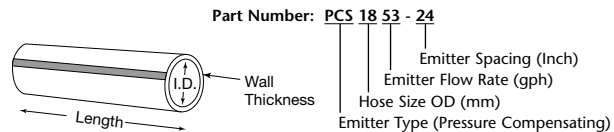

Ordering Information:

- Drip In hose is manufactured I.D. controlled.
- Drip In 0.620" ID (18mm OD) is compatible with 0.620" (16mm) ID Loc Eze Fittings. Please refer to Hose Fittings Section.
- Drip In hose is equivalent to:
 - Drip In 0.550" ID (16mm OD) EHD1443 Blue Stripe® Round Hose
 - Drip In 0.620" ID (18mm OD) EHD1643 Blue Stripe® Round Hose
 - Drip In 0.710" ID (20mm OD) EHD1845 Blue Stripe® Round Hose



To order, call Toro Micro-Irrigation
 El Cajon, Ca: +1 (800) 333-8125 or +1 (619) 562-2950
 Sanford, Fl: +1 (800) 806-6582 or +1 (407) 321-2901
 List Prices are US\$. FOB Shipping Point. Effective November 19, 2014 (ALT002)

Drip In[®] PC (Category II)

Pressure Compensating Dripline with the Blue Stripe[®] of Quality

◇ **MADE TO ORDER.** 80,000 Ft. minimum order quantity will apply. Toro Micro-Irrigation Customer Service will confirm by fax that the order has been accepted and the estimated date of delivery.

Flow rate expressed gph per individual emitter @ 30 psi (2 Bar)

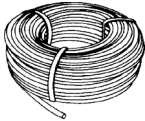

Part Number	Available Flow Rates	Emitter Spacing	Coil Length		Shipping Weight		Coils per Pallet	Coils per Truck Pallet	Loose	List Price Per Coil
			Ft.	M.	Lbs.	Kilos.				
0.550" (16mm OD) PC Dripline (0.550" ID x 0.640" OD x 0.045" Wall)										
◇ PCS16xx-12	0.42, 0.75 gph	12"	1,000	305	38.5	17.5	16	416	650	393.00
◇ PCS16xx-15	0.42, 0.75 gph	15"	1,000	305	38	17.2	16	416	650	364.00
◇ PCS16xx-18	0.42, 0.75 gph	18"	1,000	305	37	16.8	16	416	650	318.00
◇ PCS16xx-24	0.42, 0.75 gph	24"	1,000	305	36	16.3	16	416	650	294.00
◇ PCS16xx-30	0.42, 0.75 gph	30"	1,000	305	36	16.3	16	416	650	260.00
◇ PCS16xx-36	0.42, 0.75 gph	36"	1,000	305	35	15.9	16	416	650	251.00
◇ PCS16xx-42	0.42, 0.75 gph	42"	1,000	305	35	15.9	16	416	650	244.00
◇ PCS16xx-48	0.42, 0.75 gph	48"	1,000	305	35	15.9	16	416	650	238.00
◇ PCS16xx-54	0.42, 0.75 gph	54"	1,000	305	35	15.9	16	416	650	235.00
◇ PCS16xx-60	0.42, 0.75 gph	60"	1,000	305	35	15.9	16	416	650	232.00
◇ PCS16xx-66	0.42, 0.75 gph	66"	1,000	305	35	15.9	16	416	650	229.00
◇ PCS16xx-72	0.42, 0.75 gph	72"	1,000	305	35	15.9	16	416	650	227.00
0.620" (18mm OD) PC Dripline (0.620" ID x 0.710" OD x 0.045" Wall)										
◇ PCS18xx-12	0.33, 0.42, 0.75 gph	12"	1,000	305	43	19.5	14	364	475	406.00
◇ PCS18xx-15	0.33, 0.42, 0.75 gph	15"	1,000	305	42.5	19.3	14	364	475	377.00
◇ PCS18xx-18	0.33, 0.42, 0.75 gph	18"	1,000	305	42	19.1	14	364	475	331.00
◇ PCS18xx-24	0.33, 0.42, 0.75 gph	24"	1,000	305	41	18.6	14	364	475	294.00
◇ PCS18xx-30	0.33, 0.42, 0.75 gph	30"	1,000	305	40	18.1	14	364	475	277.00
◇ PCS18xx-36	0.33, 0.42, 0.75 gph	36"	1,000	305	40	18.1	14	364	475	267.00
◇ PCS18xx-42	0.33, 0.42, 0.75 gph	42"	1,000	305	39	17.7	14	364	475	260.00
◇ PCS18xx-48	0.33, 0.42, 0.75 gph	48"	1,000	305	39	17.7	14	364	475	254.00
◇ PCS18xx-54	0.33, 0.42, 0.75 gph	54"	1,000	305	39	17.7	14	364	475	251.00
◇ PCS18xx-60	0.33, 0.42, 0.75 gph	60"	1,000	305	39	17.7	14	364	475	246.00
◇ PCS18xx-66	0.33, 0.42, 0.75 gph	66"	1,000	305	39	17.7	14	364	475	245.00
◇ PCS18xx-72	0.33, 0.42, 0.75 gph	72"	1,000	305	39	17.7	14	364	475	243.00
0.710" (20mm OD) PC Dripline (0.710" ID x 0.805" OD x 0.048" Wall)										
◇ PCS20xx-12	0.42, 0.75 gph	12"	1,000	305	52	23.6	11	286	380	428.00
◇ PCS20xx-15	0.42, 0.75 gph	15"	1,000	305	52	23.6	11	286	380	398.00
◇ PCS20xx-18	0.42, 0.75 gph	18"	1,000	305	50	22.7	11	286	380	338.00
◇ PCS20xx-24	0.42, 0.75 gph	24"	1,000	305	49	22.2	11	286	380	326.00
◇ PCS20xx-30	0.42, 0.75 gph	30"	1,000	305	48	21.8	11	286	380	306.00
◇ PCS20xx-36	0.42, 0.75 gph	36"	1,000	305	48	21.8	11	286	380	295.00
◇ PCS20xx-42	0.42, 0.75 gph	42"	1,000	305	47	21.3	11	286	380	289.00
◇ PCS20xx-48	0.42, 0.75 gph	48"	1,000	305	47	21.3	11	286	380	284.00
◇ PCS20xx-54	0.42, 0.75 gph	54"	1,000	305	47	21.3	11	286	380	279.00
◇ PCS20xx-60	0.42, 0.75 gph	60"	1,000	305	47	21.3	11	286	380	277.00
◇ PCS20xx-66	0.42, 0.75 gph	66"	1,000	305	47	21.3	11	286	380	274.00
◇ PCS20xx-72	0.42, 0.75 gph	72"	1,000	305	47	21.3	11	286	380	272.00

xx Denotes emitter flow rate in gph at 30psi. Substitute xx, with the flow rate required.

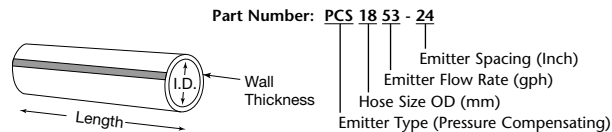

Ordering Information:

- Drip In hose is manufactured I.D. controlled.
- Drip In 0.620" ID (18mm OD) is compatible with 0.620" (16mm) ID Loc Eze Fittings. Please refer to Hose Fittings Section.
- Drip In hose is equivalent to:
 - Drip In 0.550" ID (16mm OD) EHD1443 Blue Stripe[®] Round Hose
 - Drip In 0.620" ID (18mm OD) EHD1643 Blue Stripe[®] Round Hose
 - Drip In 0.710" ID (20mm OD) EHD1845 Blue Stripe[®] Round Hose

Dripline



Drip In® PC Short Coils (Category II)
Pressure Compensating Dripline with the Blue Stripe® of Quality

◇ **MADE TO ORDER.** 80,000 Ft. minimum order quantity will apply. Toro Micro-Irrigation Customer Service will confirm by fax that the order has been accepted and the estimated date of delivery.
Flow rate expressed gph per individual emitter @ 30 psi (2 Bar)



Part Number	Available Flow Rates	Emitter Spacing	Coil Length		Shipping Weight		Shipping Cube		Coils per		Coils per Truck		List Price Per Coil
			Ft.	M.	Lbs.	Kilos.	Ft.	M.	Carton	Pallet	Pallet	Loose	
1/2" PC Dripline (0.550" ID x 0.640" OD x 0.045" Wall)													
◇ PCS1653-12-500	0.53 gph	12"	500	152	20.2	9.2	—	—	—	20	520	780	240.00
◇ PCS1610-12-500	1.0 gph	12"	500	152	20.2	9.2	—	—	—	20	520	780	240.00
◇ PCS1653-18-500	0.53 gph	18"	500	152	20.2	9.2	—	—	—	20	520	780	193.00
◇ PCS1610-18-500	1.0 gph	18"	500	152	20.2	9.2	—	—	—	20	520	780	193.00
◇ PCS1653-24-500	0.53 gph	24"	500	152	20.2	9.2	—	—	—	20	520	780	182.00
◇ PCS1610-24-500	1.0 gph	24"	500	152	20.2	9.2	—	—	—	20	520	780	182.00
5/8" PC Dripline (0.620" ID x 0.710" OD x 0.045" Wall)													
◇ PCS1853-12-100	0.53 gph	12"	100	31	5.5	2.5	1.42	0.04	6	72	1,872	—	54.70
◇ PCS1810-12-100	1.0 gph	12"	100	31	5.5	2.5	1.42	0.04	6	72	1,872	—	54.70
◇ PCS1853-18-100	0.53 gph	18"	100	31	5.5	2.5	1.42	0.04	6	72	1,872	—	47.00
◇ PCS1810-18-100	1.0 gph	18"	100	31	5.5	2.5	1.42	0.04	6	72	1,872	—	47.00
◇ PCS1853-24-100	0.53 gph	24"	Call Toro Micro-Irrigation Customer Service										
◇ PCS1810-24-100	1.0 gph	24"	100	31	5.5	2.5	1.42	0.04	6	72	1,872	—	82.00
◇ PCS1853-12-500	0.53 gph	12"	500	152	22.6	10.3	—	—	—	20	520	780	236.00
◇ PCS1810-12-500	1.0 gph	12"	500	152	22.6	10.3	—	—	—	20	520	780	236.00
◇ PCS1853-18-500	0.53 gph	18"	500	152	22.1	10.0	—	—	—	20	520	780	199.00
◇ PCS1810-18-500	1.0 gph	18"	500	152	22.1	10.0	—	—	—	20	520	780	199.00
◇ PCS1853-24-500	0.53 gph	24"	500	152	21.6	9.8	—	—	—	20	520	780	189.00
◇ PCS1810-24-500	1.0 gph	24"	500	152	21.6	9.8	—	—	—	20	520	780	189.00

Ordering Information:

- ◇ **MADE TO ORDER.** 80,000 Ft. minimum order quantity will apply. Please consult Toro Micro-Irrigation Customer Service for availability.
- Drip In hose is manufactured I.D. controlled.
- 1/2" Dripline is equivalent to 1/2" Hose (Part No. EHD1443-xxx). Please refer to Hose Section.
- 5/8" Dripline is equivalent to 5/8" Hose (Part No. EHD1645-xxx). Please refer to Hose Section.
- For spacing above 24", please consult Toro Micro-Irrigation Customer Service for availability.



Drip In[®] PC (Metric) (Category II)
Pressure Compensating Dripline with the Blue Stripe[®] of Quality

◇ **MADE TO ORDER.** 24,350 Mtr. (80,000 Ft.) minimum order quantity will apply. Toro Micro-Irrigation Customer Service will confirm by fax that the order has been accepted and the estimated date of delivery.
Flow rate expressed lph per individual emitter @ 2 Bar (30 psi)



Part Number	Available Flow Rates	Emitter Spacing	Coil Length		Shipping Weight		Coils per Container		List Price Per Coil
			Ft.	M.	Lbs.	Kilos.	20 Ft.	40Ft.	
16mm OD PC Dripline (13.97mm ID x 16.26mm OD x 1.14mm Wall)									
◇ PCS16xx-30CM-400M	1,6; 2,0; 2,8; 4,0 lph	30cm	1,310	400	50.5	22.9	160	320	517.00
◇ PCS16xx-40CM-400M	1,6; 2,0; 2,8; 4,0 lph	40cm	1,310	400	49	22.2	160	320	449.00
◇ PCS16xx-50CM-400M	1,6; 2,0; 2,8; 4,0 lph	50cm	1,310	400	48	21.8	160	320	405.00
◇ PCS16xx-60CM-400M	1,6; 2,0; 2,8; 4,0 lph	60cm	1,310	400	47.5	21.5	160	320	387.00
◇ PCS16xx-75CM-400M	1,6; 2,0; 2,8; 4,0 lph	75cm	1,310	400	47	21.3	160	320	369.00
◇ PCS16xx-80CM-400M	1,6; 2,0; 2,8; 4,0 lph	80cm	1,310	400	47	21.3	160	320	337.00
◇ PCS16xx-90CM-400M	1,6; 2,0; 2,8; 4,0 lph	90cm	1,310	400	46.5	21.1	160	320	330.00
◇ PCS16xx-100CM-400M	1,6; 2,0; 2,8; 4,0 lph	100cm	1,310	400	46	20.9	160	320	323.00
◇ PCS16xx-120CM-400M	1,6; 2,0; 2,8; 4,0 lph	120cm	1,310	400	46	20.9	160	320	313.00
◇ PCS16xx-150CM-400M	1,6; 2,0; 2,8; 4,0 lph	150cm	1,310	400	46	20.9	160	320	305.00
◇ PCS16xx-200CM-400M	1,6; 2,0; 2,8; 4,0 lph	200cm	1,310	400	46	20.9	160	320	295.00
18mm OD PC Dripline (15.75mm ID x 18.03mm OD x 1.14mm Wall)									
◇ PCS18xx-30CM-350M	1,25; 1,6; 2,0; 2,8; 4,0 lph	30cm	1,150	350	50	22.7	150	300	470.00
◇ PCS18xx-40CM-350M	1,25; 1,6; 2,0; 2,8; 4,0 lph	40cm	1,150	350	48	21.8	150	300	428.00
◇ PCS18xx-50CM-350M	1,25; 1,6; 2,0; 2,8; 4,0 lph	50cm	1,150	350	47	21.3	150	300	370.00
◇ PCS18xx-60CM-350M	1,25; 1,6; 2,0; 2,8; 4,0 lph	60cm	1,150	350	47	21.3	150	300	353.00
◇ PCS18xx-75CM-350M	1,25; 1,6; 2,0; 2,8; 4,0 lph	75cm	1,150	350	46	20.9	150	300	336.00
◇ PCS18xx-80CM-350M	1,25; 1,6; 2,0; 2,8; 4,0 lph	80cm	1,150	350	46	20.9	150	300	313.00
◇ PCS18xx-90CM-350M	1,25; 1,6; 2,0; 2,8; 4,0 lph	90cm	1,150	350	46	20.9	150	300	308.00
◇ PCS18xx-100CM-350M	1,25; 1,6; 2,0; 2,8; 4,0 lph	100cm	1,150	350	45	20.4	150	300	289.00
◇ PCS18xx-120CM-350M	1,25; 1,6; 2,0; 2,8; 4,0 lph	120cm	1,150	350	45	20.4	150	300	286.00
◇ PCS18xx-150CM-350M	1,25; 1,6; 2,0; 2,8; 4,0 lph	150cm	1,150	350	45	20.4	150	300	285.00
◇ PCS18xx-200CM-350M	1,25; 1,6; 2,0; 2,8; 4,0 lph	200cm	1,150	350	45	20.4	150	300	277.00
20mm OD PC Dripline (18.03mm ID x 20.46mm OD x 1.20mm Wall)									
◇ PCS20xx-30CM-305M	1,6; 2,0; 2,8; 4,0 lph	30cm	1,000	305	52	23.6	135	275	432.00
◇ PCS20xx-40CM-305M	1,6; 2,0; 2,8; 4,0 lph	40cm	1,000	305	50	22.7	135	275	394.00
◇ PCS20xx-50CM-305M	1,6; 2,0; 2,8; 4,0 lph	50cm	1,000	305	49	22.2	135	275	343.00
◇ PCS20xx-60CM-305M	1,6; 2,0; 2,8; 4,0 lph	60cm	1,000	305	48	21.8	135	275	327.00
◇ PCS20xx-75CM-305M	1,6; 2,0; 2,8; 4,0 lph	75cm	1,000	305	48	21.8	135	275	313.00
◇ PCS20xx-80CM-305M	1,6; 2,0; 2,8; 4,0 lph	80cm	1,000	305	47	21.3	135	275	303.00
◇ PCS20xx-90CM-305M	1,6; 2,0; 2,8; 4,0 lph	90cm	1,000	305	47	21.3	135	275	296.00
◇ PCS20xx-100CM-305M	1,6; 2,0; 2,8; 4,0 lph	100cm	1,000	305	47	21.3	135	275	292.00
◇ PCS20xx-120CM-305M	1,6; 2,0; 2,8; 4,0 lph	120cm	1,000	305	47	21.3	135	275	285.00
◇ PCS20xx-150CM-305M	1,6; 2,0; 2,8; 4,0 lph	150cm	1,000	305	47	21.3	135	275	278.00
◇ PCS20xx-200CM-305M	1,6; 2,0; 2,8; 4,0 lph	200cm	1,000	305	47	21.3	135	275	271.00

xx Denotes emitter flow rate in lph at 2 bar. Substitute xx, with the flow rate required.

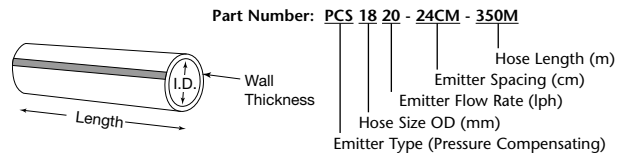

Ordering Information:

- Drip In hose is manufactured I.D. controlled.
- Drip In 0.620" ID (18mm OD) is compatible with 0.620" (16mm) ID Loc Eze Fittings. Please refer to Hose Fittings Section.
- Drip In hose is equivalent to:
 - Drip In 0.550" ID (16mm OD) EHD1443 Blue Stripe[®] Round Hose
 - Drip In 0.620" ID (18mm OD) EHD1643 Blue Stripe[®] Round Hose
 - Drip In 0.710" ID (20mm OD) EHD1845 Blue Stripe[®] Round Hose

Dripline

Drip In® Classic

Drip In® Classic (Category II)

Non-Pressure Compensating Dripline with the Blue Stripe® of Quality

◇ **MADE TO ORDER.** 20,000 Ft. minimum order quantity will apply. Toro Micro-Irrigation Customer Service will confirm by fax that the order has been accepted and the estimated date of delivery.
Flow rate expressed gph per individual emitter @ 1.5 psi (1 Bar)

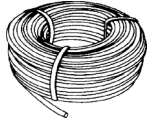

Part Number	Available Flow Rates	Emitter Spacing	Coil Length		Shipping Weight		Coils per Pallet	Coils per Truck		List Price Per Coil
			Ft.	M.	Lbs.	Kilos.		Pallet	Loose	
0.550" (16mm OD) Classic Dripline (0.550" ID x 0.640" OD x 0.045" Wall)										
◇ CS16xx-12	0.53, 1.00 gph	12"	1,000	305	43	19.5	16	416	650	347.00
◇ CS16xx-15	0.53, 1.00 gph	15"	1,000	305	42	19.1	16	416	650	327.00
◇ CS16xx-18	0.53, 1.00 gph	18"	1,000	305	40	18.1	16	416	650	288.00
◇ CS16xx-24	0.53, 1.00 gph	24"	1,000	305	39	17.7	16	416	650	272.00
◇ CS16xx-30	0.53, 1.00 gph	30"	1,000	305	38	17.2	16	416	650	243.00
◇ CS16xx-36	0.53, 1.00 gph	36"	1,000	305	37	16.8	16	416	650	235.00
◇ CS16xx-42	0.53, 1.00 gph	42"	1,000	305	36.5	16.6	16	416	650	232.00
◇ CS16xx-48	0.53, 1.00 gph	48"	1,000	305	36	16.3	16	416	650	228.00
◇ CS16xx-54	0.53, 1.00 gph	54"	1,000	305	36	16.3	16	416	650	226.00
◇ CS16xx-60	0.53, 1.00 gph	60"	1,000	305	36	16.3	16	416	650	223.00
◇ CS16xx-66	0.53, 1.00 gph	66"	1,000	305	36	16.3	16	416	650	221.00
◇ CS16xx-72	0.53, 1.00 gph	72"	1,000	305	36	16.3	16	416	650	220.00
0.620" (18mm OD) Classic Dripline (0.620" ID x 0.710" OD x 0.045" Wall)										
◇ CS18xx-12	0.53, 1.00 gph	12"	1,000	305	50	22.7	14	364	530	360.00
◇ CS18xx-15	0.53, 1.00 gph	15"	1,000	305	48	21.8	14	364	530	344.00
◇ CS18xx-18	0.53, 1.00 gph	18"	1,000	305	46	20.9	14	364	530	297.00
◇ CS18xx-24	0.53, 1.00 gph	24"	1,000	305	44	20.0	14	364	530	283.00
◇ CS18xx-30	0.53, 1.00 gph	30"	1,000	305	43	19.5	14	364	530	257.00
◇ CS18xx-36	0.53, 1.00 gph	36"	1,000	305	42	19.1	14	364	530	251.00
◇ CS18xx-42	0.53, 1.00 gph	42"	1,000	305	41	18.6	14	364	530	246.00
◇ CS18xx-48	0.53, 1.00 gph	48"	1,000	305	41	18.6	14	364	530	243.00
◇ CS18xx-54	0.53, 1.00 gph	54"	1,000	305	40.5	18.4	14	364	530	241.00
◇ CS18xx-60	0.53, 1.00 gph	60"	1,000	305	40	18.1	14	364	530	240.00
◇ CS18xx-66	0.53, 1.00 gph	66"	1,000	305	40	18.1	14	364	530	237.00
◇ CS18xx-72	0.53, 1.00 gph	72"	1,000	305	40	18.1	14	364	530	236.00
0.710" (20mm OD) Classic Dripline (0.710" ID x 0.805" OD x 0.048" Wall)										
◇ CS20xx-12	0.53, 1.00 gph	12"	1,000	305	56.5	25.6	11	286	380	377.00
◇ CS20xx-15	0.53, 1.00 gph	15"	1,000	305	55	24.9	11	286	380	357.00
◇ CS20xx-18	0.53, 1.00 gph	18"	1,000	305	53	24.0	11	286	380	317.00
◇ CS20xx-24	0.53, 1.00 gph	24"	1,000	305	51	23.1	11	286	380	301.00
◇ CS20xx-30	0.53, 1.00 gph	30"	1,000	305	50	22.7	11	286	380	285.00
◇ CS20xx-36	0.53, 1.00 gph	36"	1,000	305	49	22.2	11	286	380	279.00
◇ CS20xx-42	0.53, 1.00 gph	42"	1,000	305	49	22.2	11	286	380	275.00
◇ CS20xx-48	0.53, 1.00 gph	48"	1,000	305	48	21.8	11	286	380	272.00
◇ CS20xx-54	0.53, 1.00 gph	54"	1,000	305	48	21.8	11	286	380	268.00
◇ CS20xx-60	0.53, 1.00 gph	60"	1,000	305	48	21.8	11	286	380	266.00
◇ CS20xx-66	0.53, 1.00 gph	66"	1,000	305	48	21.8	11	286	380	263.00
◇ CS20xx-72	0.53, 1.00 gph	72"	1,000	305	48	21.8	11	286	380	262.00

xx Denotes emitter flow rate in gph at 1.5psi. Substitute xx, with the flow rate required.

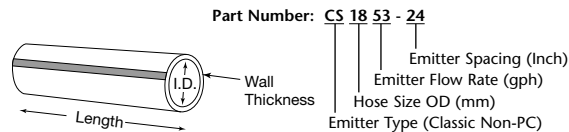

Ordering Information:

- Drip In hose is manufactured I.D. controlled.
- Drip In 0.620" ID (18mm OD) is compatible with 0.620" (16mm) ID Loc Eze Fittings. Please refer to Hose Fittings Section.
- Drip In hose is equivalent to:

Drip In 0.550" ID (16mm OD)	EHD1443	Blue Stripe® Round Hose
Drip In 0.620" ID (18mm OD)	EHD1643	Blue Stripe® Round Hose
Drip In 0.710" ID (20mm OD)	EHD1845	Blue Stripe® Round Hose



Dripline

Drip In® Classic

Drip In® Classic (Category II)

Non-Pressure Compensating Dripline with the Blue Stripe® of Quality

◇ **MADE TO ORDER.** 80,000 Ft. minimum order quantity will apply. Toro Micro-Irrigation Customer Service will confirm by fax that the order has been accepted and the estimated date of delivery.

Flow rate expressed gph per individual emitter @ 15 psi (1 Bar)



Part Number	Available Flow Rates	Emitter Spacing	Coil Length		Shipping Weight		Coils per Pallet	Coils per Truck		List Price Per Coil
			Ft.	M.	Lbs.	Kilos.		Pallet	Loose	
0.550" (16mm OD) Classic Dripline (0.550" ID x 0.640" OD x 0.045" Wall)										
◇ CS16xx-12	0.75, 1.80 gph	12"	1,000	305	43	19.5	16	416	650	347.00
◇ CS16xx-15	0.75, 1.80 gph	15"	1,000	305	42	19.1	16	416	650	327.00
◇ CS16xx-18	0.75, 1.80 gph	18"	1,000	305	40	18.1	16	416	650	288.00
◇ CS16xx-24	0.75, 1.80 gph	24"	1,000	305	39	17.7	16	416	650	272.00
◇ CS16xx-30	0.75, 1.80 gph	30"	1,000	305	38	17.2	16	416	650	243.00
◇ CS16xx-36	0.75, 1.80 gph	36"	1,000	305	37	16.8	16	416	650	235.00
◇ CS16xx-42	0.75, 1.80 gph	42"	1,000	305	36.5	16.6	16	416	650	232.00
◇ CS16xx-48	0.75, 1.80 gph	48"	1,000	305	36	16.3	16	416	650	228.00
◇ CS16xx-54	0.75, 1.80 gph	54"	1,000	305	36	16.3	16	416	650	226.00
◇ CS16xx-60	0.75, 1.80 gph	60"	1,000	305	36	16.3	16	416	650	223.00
◇ CS16xx-66	0.75, 1.80 gph	66"	1,000	305	36	16.3	16	416	650	221.00
◇ CS16xx-72	0.75, 1.80 gph	72"	1,000	305	36	16.3	16	416	650	220.00
0.620" (18mm OD) Classic Dripline (0.620" ID x 0.710" OD x 0.045" Wall)										
◇ CS18xx-12	0.75, 2.00 gph	12"	1,000	305	50	22.7	14	364	530	360.00
◇ CS18xx-15	0.75, 2.00 gph	15"	1,000	305	48	21.8	14	364	530	344.00
◇ CS18xx-18	0.75, 2.00 gph	18"	1,000	305	46	20.9	14	364	530	297.00
◇ CS18xx-24	0.75, 2.00 gph	24"	1,000	305	44	20.0	14	364	530	283.00
◇ CS18xx-30	0.75, 2.00 gph	30"	1,000	305	43	19.5	14	364	530	257.00
◇ CS18xx-36	0.75, 2.00 gph	36"	1,000	305	42	19.1	14	364	530	251.00
◇ CS18xx-42	0.75, 2.00 gph	42"	1,000	305	41	18.6	14	364	530	246.00
◇ CS18xx-48	0.75, 2.00 gph	48"	1,000	305	41	18.6	14	364	530	243.00
◇ CS18xx-54	0.75, 2.00 gph	54"	1,000	305	40.5	18.4	14	364	530	241.00
◇ CS18xx-60	0.75, 2.00 gph	60"	1,000	305	40	18.1	14	364	530	240.00
◇ CS18xx-66	0.75, 2.00 gph	66"	1,000	305	40	18.1	14	364	530	237.00
◇ CS18xx-72	0.75, 2.00 gph	72"	1,000	305	40	18.1	14	364	530	236.00

xx Denotes emitter flow rate in gph at 15psi. Substitute xx, with the flow rate required.

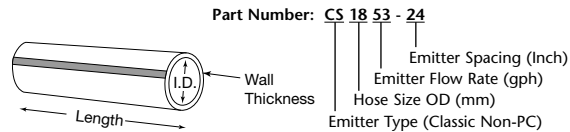

Ordering Information:

- Drip In hose is manufactured I.D. controlled.
- Drip In 0.620" ID (18mm OD) is compatible with 0.620" (16mm) ID Loc Eze Fittings. Please refer to Hose Fittings Section.
- Drip In hose is equivalent to:
 - Drip In 0.550" ID (16mm OD) EHD1443 Blue Stripe® Round Hose
 - Drip In 0.620" ID (18mm OD) EHD1643 Blue Stripe® Round Hose
 - Drip In 0.710" ID (20mm OD) EHD1845 Blue Stripe® Round Hose



Dripline

Drip In® Classic

Drip In® Classic (Metric) (Category II) Non-Pressure Compensating Dripline with the Blue Stripe® of Quality

◇ **MADE TO ORDER.** 24,350 Mtr. (80,000 Ft.) minimum order quantity will apply. Toro Micro-Irrigation Customer Service will confirm by fax that the order has been accepted and the estimated date of delivery.
Flow rate expressed lph per individual emitter @ 1 Bar (15 psi)

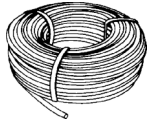

Part Number	Available Flow Rates	Emitter Spacing	Coil Length		Shipping Weight		Coils per Container		List Price Per Coil
			Ft.	M.	Lbs.	Kilos.	20 Ft.	40Ft.	
16mm OD Classic Dripline (13.97mm ID x 16.26mm OD x 1.14mm Wall)									
◇ CS16xx-30CM-400M	2,0; 2,8; 4,0; 6,8 lph	30cm	1,310	400	56	25.4	160	320	457.00
◇ CS16xx-40CM-400M	2,0; 2,8; 4,0; 6,8 lph	40cm	1,310	400	54	24.5	160	320	414.00
◇ CS16xx-50CM-400M	2,0; 2,8; 4,0; 6,8 lph	50cm	1,310	400	51.5	23.4	160	320	370.00
◇ CS16xx-60CM-400M	2,0; 2,8; 4,0; 6,8 lph	60cm	1,310	400	50.5	22.9	160	320	357.00
◇ CS16xx-75CM-400M	2,0; 2,8; 4,0; 6,8 lph	75cm	1,310	400	49	22.2	160	320	344.00
◇ CS16xx-80CM-400M	2,0; 2,8; 4,0; 6,8 lph	80cm	1,310	400	49	22.2	160	320	314.00
◇ CS16xx-90CM-400M	2,0; 2,8; 4,0; 6,8 lph	90cm	1,310	400	48.5	22.0	160	320	309.00
◇ CS16xx-100CM-400M	2,0; 2,8; 4,0; 6,8 lph	100cm	1,310	400	48	21.8	160	320	306.00
◇ CS16xx-120CM-400M	2,0; 2,8; 4,0; 6,8 lph	120cm	1,310	400	47.5	21.5	160	320	297.00
◇ CS16xx-150CM-400M	2,0; 2,8; 4,0; 6,8 lph	150cm	1,310	400	47	21.3	160	320	292.00
◇ CS16xx-200CM-400M	2,0; 2,8; 4,0; 6,8 lph	200cm	1,310	400	47	21.3	160	320	286.00
18mm OD Classic Dripline (15.75mm ID x 18.03mm OD x 1.14mm Wall)									
◇ CS18xx-30CM-350M	2,0; 2,8; 4,0; 7,6 lph	30cm	1,150	350	57	25.9	150	300	414.00
◇ CS18xx-40CM-350M	2,0; 2,8; 4,0; 7,6 lph	40cm	1,150	350	54	24.5	150	300	384.00
◇ CS18xx-50CM-350M	2,0; 2,8; 4,0; 7,6 lph	50cm	1,150	350	52	23.6	150	300	336.00
◇ CS18xx-60CM-350M	2,0; 2,8; 4,0; 7,6 lph	60cm	1,150	350	50	22.7	150	300	325.00
◇ CS18xx-75CM-350M	2,0; 2,8; 4,0; 7,6 lph	75cm	1,150	350	49	22.2	150	300	313.00
◇ CS18xx-80CM-350M	2,0; 2,8; 4,0; 7,6 lph	80cm	1,150	350	49	22.2	150	300	292.00
◇ CS18xx-90CM-350M	2,0; 2,8; 4,0; 7,6 lph	90cm	1,150	350	48	21.8	150	300	288.00
◇ CS18xx-100CM-350M	2,0; 2,8; 4,0; 7,6 lph	100cm	1,150	350	48	21.8	150	300	285.00
◇ CS18xx-120CM-350M	2,0; 2,8; 4,0; 7,6 lph	120cm	1,150	350	47	21.3	150	300	279.00
◇ CS18xx-150CM-350M	2,0; 2,8; 4,0; 7,6 lph	150cm	1,150	350	46	20.9	150	300	274.00
◇ CS18xx-200CM-350M	2,0; 2,8; 4,0; 7,6 lph	200cm	1,150	350	46	20.9	150	300	267.00
20mm OD Classic Dripline (18.03mm ID x 20.46mm OD x 1.20mm Wall)									
◇ CS20xx-30CM-305M	2,0; 4,0 lph	30cm	1,000	305	56.5	25.6	135	275	378.00
◇ CS20xx-40CM-305M	2,0; 4,0 lph	40cm	1,000	305	54	24.5	135	275	353.00
◇ CS20xx-50CM-305M	2,0; 4,0 lph	50cm	1,000	305	52	23.6	135	275	312.00
◇ CS20xx-60CM-305M	2,0; 4,0 lph	60cm	1,000	305	51	23.1	135	275	302.00
◇ CS20xx-75CM-305M	2,0; 4,0 lph	75cm	1,000	305	50	22.7	135	275	292.00
◇ CS20xx-80CM-305M	2,0; 4,0 lph	80cm	1,000	305	50	22.7	135	275	284.00
◇ CS20xx-90CM-305M	2,0; 4,0 lph	90cm	1,000	305	49	22.2	135	275	279.00
◇ CS20xx-100CM-305M	2,0; 4,0 lph	100cm	1,000	305	49	22.2	135	275	277.00
◇ CS20xx-120CM-305M	2,0; 4,0 lph	120cm	1,000	305	48	21.8	135	275	272.00
◇ CS20xx-150CM-305M	2,0; 4,0 lph	150cm	1,000	305	48	21.8	135	275	267.00
◇ CS20xx-200CM-305M	2,0; 4,0 lph	200cm	1,000	305	48	21.8	135	275	261.00

xx Denotes emitter flow rate in lph at 1 bar. Substitute xx, with the flow rate required.

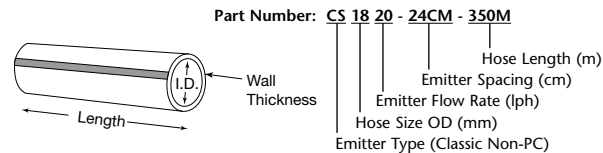

Ordering Information:

- Drip In hose is manufactured I.D. controlled.
- Drip In 0.620" ID (18mm OD) is compatible with 0.620" (16mm) ID Loc Eze Fittings. Please refer to Hose Fittings Section.
- Drip In hose is equivalent to:

Drip In 0.550" ID (16mm OD)	EHD1443 Blue Stripe® Round Hose
Drip In 0.620" ID (18mm OD)	EHD1643 Blue Stripe® Round Hose
Drip In 0.710" ID (20mm OD)	EHD1845 Blue Stripe® Round Hose



Dripline

Drip In® with ROOTGUARD

Drip In® PC with Rootguard® (Category II)

Pressure Compensating Dripline Protection for SDI (Subsurface Drip Irrigation) Applications

◇ **MADE TO ORDER.** 80,000 Ft. minimum order quantity will apply. Toro Micro-Irrigation Customer Service will confirm by fax that the order has been accepted and the estimated date of delivery.

Flow rate expressed gph per individual emitter @ 30 psi (2 Bar)

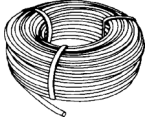

Part Number	Available Flow Rates	Emitter Spacing	Coil Length		Shipping Weight		Coils per Pallet	Coils per Truck		List Price Per Coil
			Ft.	M.	Lbs.	Kilos.		Pallet	Loose	
0.550" (16mm OD) PC Dripline with Rootguard (0.550" ID x 0.640" OD x 0.045" Wall)										
◇ RGPCD16xx-12	.42, .53, 1.0 gph	12"	1,000	305	36	16.3	16	416	650	442.00
◇ RGPCD16xx-18	.42, .53, 1.0 gph	18"	1,000	305	36	16.3	16	416	650	354.00
◇ RGPCD16xx-24	.42, .53, 1.0 gph	24"	1,000	305	36	16.3	16	416	650	352.00
◇ RGPCD16xx-30	.42, .53, 1.0 gph	30"	1,000	305	36	16.3	16	416	650	308.00
◇ RGPCD16xx-36	.42, .53, 1.0 gph	36"	1,000	305	35	15.9	16	416	650	289.00
◇ RGPCD16xx-42	.42, .53, 1.0 gph	42"	1,000	305	35	15.9	16	416	650	278.00
◇ RGPCD16xx-48	.42, .53, 1.0 gph	48"	1,000	305	35	15.9	16	416	650	268.00
◇ RGPCD16xx-54	.42, .53, 1.0 gph	54"	1,000	305	35	15.9	16	416	650	261.00
◇ RGPCD16xx-60	.42, .53, 1.0 gph	60"	1,000	305	35	15.9	16	416	650	255.00
0.620" (18mm OD) PC Dripline with Rootguard (0.620" ID x 0.710" OD x 0.045" Wall)										
◇ RGPCD18xx-12	.42, .53, .75, 1.0 gph	12"	1,000	305	41	18.6	14	364	530	483.00
◇ RGPCD18xx-18	.42, .53, .75, 1.0 gph	18"	1,000	305	41	18.6	14	364	530	387.00
◇ RGPCD18xx-24	.42, .53, .75, 1.0 gph	24"	1,000	305	41	18.6	14	364	530	353.00
◇ RGPCD18xx-30	.42, .53, .75, 1.0 gph	30"	1,000	305	40	18.1	14	364	530	317.00
◇ RGPCD18xx-36	.42, .53, .75, 1.0 gph	36"	1,000	305	40	18.1	14	364	530	303.00
◇ RGPCD18xx-42	.42, .53, .75, 1.0 gph	42"	1,000	305	39	17.7	14	364	530	293.00
◇ RGPCD18xx-48	.42, .53, .75, 1.0 gph	48"	1,000	305	39	17.7	14	364	530	286.00
◇ RGPCD18xx-54	.42, .53, .75, 1.0 gph	54"	1,000	305	39	17.7	14	364	530	280.00
◇ RGPCD18xx-60	.42, .53, .75, 1.0 gph	60"	1,000	305	39	17.7	14	364	530	276.00
0.710" (20mm OD) PC Dripline with Rootguard (0.710" ID x 0.805" OD x 0.048" Wall)										
◇ RGPCD20xx-12	.42, .53, .75, 1.0 gph	12"	1,000	305	50	22.7	11	286	380	251.00
◇ RGPCD20xx-18	.42, .53, .75, 1.0 gph	18"	1,000	305	50	22.7	11	286	380	202.00
◇ RGPCD20xx-24	.42, .53, .75, 1.0 gph	24"	1,000	305	49	22.2	11	286	380	376.00
◇ RGPCD20xx-30	.42, .53, .75, 1.0 gph	30"	1,000	305	48	21.8	11	286	380	350.00
◇ RGPCD20xx-36	.42, .53, .75, 1.0 gph	36"	1,000	305	48	21.8	11	286	380	336.00
◇ RGPCD20xx-42	.42, .53, .75, 1.0 gph	42"	1,000	305	47	21.3	11	286	380	326.00
◇ RGPCD20xx-48	.42, .53, .75, 1.0 gph	48"	1,000	305	47	21.3	11	286	380	319.00
◇ RGPCD20xx-54	.42, .53, .75, 1.0 gph	54"	1,000	305	47	21.3	11	286	380	313.00
◇ RGPCD20xx-60	.42, .53, .75, 1.0 gph	60"	1,000	305	47	21.3	11	286	380	308.00

xx Denotes emitter flow rate in gph at 30 psi. Substitute xx, with the flow rate required.

Drip In® PC with Rootguard® (Category II)

Pressure Compensating Dripline Protection for SDI (Subsurface Drip Irrigation) Applications

◇ **MADE TO ORDER.** 80,000 Ft. minimum order quantity will apply. Toro Micro-Irrigation Customer Service will confirm by fax that the order has been accepted and the estimated date of delivery.

Flow rate expressed gph per individual emitter @ 30 psi (2 Bar)



Part Number	Available Flow Rates	Emitter Spacing	Coil Length		Shipping Weight		Coils per Pallet	Coils per Truck		List Price Per Coil
			Ft.	M.	Lbs.	Kilos.		Pallet	Loose	
0.550" (16mm OD) PC Dripline with Rootguard (0.550" ID x 0.640" OD x 0.045" Wall)										
◇ RGPCD16xx-12-500	.53, 1.0 gph	12"	500	152.5	18	8.2	16	520	832	221.00
◇ RGPCD16xx-18-500	.53, 1.0 gph	18"	500	152.5	18	8.2	16	520	832	177.00
◇ RGPCD16xx-24-500	.53, 1.0 gph	24"	500	152.5	18	8.2	16	520	832	176.00
◇ RGPCD16xx-30-500	.53, 1.0 gph	30"	500	152.5	18	8.2	16	520	832	154.00
◇ RGPCD16xx-36-500	.53, 1.0 gph	36"	500	152.5	17.5	7.9	16	520	832	145.00
◇ RGPCD16xx-42-500	.53, 1.0 gph	42"	500	152.5	17.5	7.9	16	520	832	139.00
◇ RGPCD16xx-48-500	.53, 1.0 gph	48"	500	152.5	17.5	7.9	16	520	832	134.00
◇ RGPCD16xx-54-500	.53, 1.0 gph	54"	500	152.5	17.5	7.9	16	520	832	132.00
◇ RGPCD16xx-60-500	.53, 1.0 gph	60"	500	152.5	17.5	7.9	16	520	832	128.00
0.620" (18mm OD) PC Dripline with Rootguard (0.620" ID x 0.710" OD x 0.045" Wall)										
◇ RGPCD18xx-12-500	.42, .53, .75, 1.0 gph	12"	500	152.5	20.5	9.3	14	520	780	242.00
◇ RGPCD18xx-18-500	.42, .53, .75, 1.0 gph	18"	500	152.5	20.5	9.3	14	520	780	194.00
◇ RGPCD18xx-24-500	.42, .53, .75, 1.0 gph	24"	500	152.5	20.5	9.3	14	520	780	177.00
◇ RGPCD18xx-30-500	.42, .53, .75, 1.0 gph	30"	500	152.5	20	9.1	14	520	780	159.00
◇ RGPCD18xx-36-500	.42, .53, .75, 1.0 gph	36"	500	152.5	20	9.1	14	520	780	153.00
◇ RGPCD18xx-42-500	.42, .53, .75, 1.0 gph	42"	500	152.5	19.5	8.8	14	520	780	147.00
◇ RGPCD18xx-48-500	.42, .53, .75, 1.0 gph	48"	500	152.5	19.5	8.8	14	520	780	143.00
◇ RGPCD18xx-54-500	.42, .53, .75, 1.0 gph	54"	500	152.5	19.5	8.8	14	520	780	142.00
◇ RGPCD18xx-60-500	.42, .53, .75, 1.0 gph	60"	500	152.5	19.5	8.8	14	520	780	138.00
0.710" (20mm OD) PC Dripline with Rootguard (0.710" ID x 0.805" OD x 0.048" Wall)										
◇ RGPCD20xx-12-500	.42, .53, .75, 1.0 gph	12"	500	152.5	25	11.3	11	468	600	254.00
◇ RGPCD20xx-18-500	.42, .53, .75, 1.0 gph	18"	500	152.5	25	11.3	11	468	600	206.00
◇ RGPCD20xx-24-500	.42, .53, .75, 1.0 gph	24"	500	152.5	24.5	11.1	11	468	600	188.00
◇ RGPCD20xx-30-500	.42, .53, .75, 1.0 gph	30"	500	152.5	24	10.9	11	468	600	175.00
◇ RGPCD20xx-36-500	.42, .53, .75, 1.0 gph	36"	500	152.5	24	10.9	11	468	600	168.00
◇ RGPCD20xx-42-500	.42, .53, .75, 1.0 gph	42"	500	152.5	23.5	10.7	11	468	600	163.00
◇ RGPCD20xx-48-500	.42, .53, .75, 1.0 gph	48"	500	152.5	23.5	10.7	11	468	600	160.00
◇ RGPCD20xx-54-500	.42, .53, .75, 1.0 gph	54"	500	152.5	23.5	10.7	11	468	600	158.00
◇ RGPCD20xx-60-500	.42, .53, .75, 1.0 gph	60"	500	152.5	23.5	10.7	11	468	600	154.00

xx Denotes emitter flow rate in gph at 30 psi. Substitute xx, with the flow rate required.



Dripline

Drip In® with ROOTGUARD

Drip In® Classic® with Rootguard® (Category II)

Non-Pressure Compensating Dripline Protection for SDI (Subsurface Drip Irrigation) Applications

◇ **MADE TO ORDER.** 80,000 Ft. minimum order quantity will apply. Toro Micro-Irrigation Customer Service will confirm by fax that the order has been accepted and the estimated date of delivery.

Flow rate expressed gph per individual emitter @ 15 psi (1 Bar)

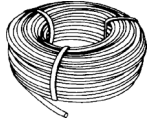

Part Number	Available Flow Rates	Emitter Spacing	Coil Length		Shipping Weight		Coils per Pallet	Coils per Truck		List Price Per Coil
			Ft.	M.	Lbs.	Kilos.		Pallet	Loose	
0.550" (16mm OD) Classic Dripline with Rootguard (0.550" ID x 0.640" OD x 0.045" Wall)										
◇ RGCD16xx-12	.53, .75, 1.0, 1.80 gph	12"	1,000	305	40	18.1	16	416	650	455.00
◇ RGCD16xx-18	.53, .75, 1.0, 1.80 gph	18"	1,000	305	40	18.1	16	416	650	386.00
◇ RGCD16xx-24	.53, .75, 1.0, 1.80 gph	24"	1,000	305	39	17.7	16	416	650	325.00
◇ RGCD16xx-30	.53, .75, 1.0, 1.80 gph	30"	1,000	305	38	17.2	16	416	650	285.00
◇ RGCD16xx-36	.53, .75, 1.0, 1.80 gph	36"	1,000	305	37	16.8	16	416	650	272.00
◇ RGCD16xx-42	.53, .75, 1.0, 1.80 gph	42"	1,000	305	36.5	16.6	16	416	650	262.00
◇ RGCD16xx-48	.53, .75, 1.0, 1.80 gph	48"	1,000	305	36	16.3	16	416	650	255.00
◇ RGCD16xx-54	.53, .75, 1.0, 1.80 gph	54"	1,000	305	36	16.3	16	416	650	250.00
◇ RGCD16xx-60	.53, .75, 1.0, 1.80 gph	60"	1,000	305	36	16.3	16	416	650	245.00
0.620" (18mm OD) Classic Dripline with Rootguard (0.620" ID x 0.710" OD x 0.045" Wall)										
◇ RGCD18xx-12	.53, .75, 1.0, 2.0 gph	12"	1,000	305	45	20.4	14	364	530	464.00
◇ RGCD18xx-18	.53, .75, 1.0, 2.0 gph	18"	1,000	305	45	20.4	14	364	530	370.00
◇ RGCD18xx-24	.53, .75, 1.0, 2.0 gph	24"	1,000	305	44	20.0	14	364	530	336.00
◇ RGCD18xx-30	.53, .75, 1.0, 2.0 gph	30"	1,000	305	43	19.5	14	364	530	301.00
◇ RGCD18xx-36	.53, .75, 1.0, 2.0 gph	36"	1,000	305	42	19.1	14	364	530	286.00
◇ RGCD18xx-42	.53, .75, 1.0, 2.0 gph	42"	1,000	305	41	18.6	14	364	530	277.00
◇ RGCD18xx-48	.53, .75, 1.0, 2.0 gph	48"	1,000	305	41	18.6	14	364	530	268.00
◇ RGCD18xx-54	.53, .75, 1.0, 2.0 gph	54"	1,000	305	40.5	18.4	14	364	530	263.00
◇ RGCD18xx-60	.53, .75, 1.0, 2.0 gph	60"	1,000	305	40	18.1	14	364	530	258.00
0.710" (20mm OD) Classic Dripline with Rootguard (0.710" ID x 0.805" OD x 0.048" Wall)										
◇ RGCD20xx-12	.53, 1.0 gph	12"	1,000	305	52	23.6	11	286	380	584.00
◇ RGCD20xx-18	.53, 1.0 gph	18"	1,000	305	52	23.6	11	286	380	473.00
◇ RGCD20xx-24	.53, 1.0 gph	24"	1,000	305	51	23.1	11	286	380	381.00
◇ RGCD20xx-30	.53, 1.0 gph	30"	1,000	305	50	22.7	11	286	380	350.00
◇ RGCD20xx-36	.53, 1.0 gph	36"	1,000	305	49	22.2	11	286	380	333.00
◇ RGCD20xx-42	.53, 1.0 gph	42"	1,000	305	49	22.2	11	286	380	320.00
◇ RGCD20xx-48	.53, 1.0 gph	48"	1,000	305	48	21.8	11	286	380	312.00
◇ RGCD20xx-54	.53, 1.0 gph	54"	1,000	305	48	21.8	11	286	380	305.00
◇ RGCD20xx-60	.53, 1.0 gph	60"	1,000	305	48	21.8	11	286	380	297.00

xx Denotes emitter flow rate in gph at 15 psi. Substitute xx, with the flow rate required.

Ordering Information:

- Drip In hose is manufactured I.D. controlled.
- Drip In 0.620" ID (18mm OD) is compatible with 0.620" (16mm) ID Loc Eze Fittings. Please refer to Hose Fittings Section.



Dripline

Drip In® with ROOTGUARD

Drip In® Classic® with Rootguard® (Category II)
 Non-Pressure Compensating Dripline Protection for SDI (Subsurface Drip Irrigation) Applications

◇ **MADE TO ORDER.** 80,000 Ft. minimum order quantity will apply. Toro Micro-Irrigation Customer Service will confirm by fax that the order has been accepted and the estimated date of delivery.
 Flow rate expressed gph per individual emitter @ 15 psi (1 Bar)

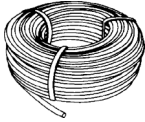

Part Number	Available Flow Rates	Emitter Spacing	Coil Length		Shipping Weight		Coils per Pallet	Coils per Truck		List Price Per Coil
			Ft.	M.	Lbs.	Kilos.		Pallet	Loose	
0.550" (16mm OD) Classic Dripline with Rootguard (0.550" ID x 0.640" OD x 0.045" Wall)										
◇ RGCD16xx-12-500	.53, .75, 1.0, 1.80 gph	12"	500	152.5	20	9.1	20	520	832	228.00
◇ RGCD16xx-18-500	.53, .75, 1.0, 1.80 gph	18"	500	152.5	20	9.1	20	520	832	193.00
◇ RGCD16xx-24-500	.53, .75, 1.0, 1.80 gph	24"	500	152.5	19.5	8.8	20	520	832	163.00
◇ RGCD16xx-30-500	.53, .75, 1.0, 1.80 gph	30"	500	152.5	19	8.6	20	520	832	143.00
◇ RGCD16xx-36-500	.53, .75, 1.0, 1.80 gph	36"	500	152.5	18.5	8.4	20	520	832	136.00
◇ RGCD16xx-42-500	.53, .75, 1.0, 1.80 gph	42"	500	152.5	18.25	8.3	20	520	832	131.00
◇ RGCD16xx-48-500	.53, .75, 1.0, 1.80 gph	48"	500	152.5	18	8.2	20	520	832	128.00
◇ RGCD16xx-54-500	.53, .75, 1.0, 1.80 gph	54"	500	152.5	18	8.2	20	520	832	127.00
◇ RGCD16xx-60-500	.53, .75, 1.0, 1.80 gph	60"	500	152.5	18	8.2	20	520	832	123.00
0.620" (18mm OD) Classic Dripline with Rootguard (0.620" ID x 0.710" OD x 0.045" Wall)										
◇ RGCD18xx-12-500	.53, .75, 1.0, 2.0 gph	12"	500	152.5	22.5	10.2	20	520	780	232.00
◇ RGCD18xx-18-500	.53, .75, 1.0, 2.0 gph	18"	500	152.5	22.5	10.2	20	520	780	185.00
◇ RGCD18xx-24-500	.53, .75, 1.0, 2.0 gph	24"	500	152.5	22	10.0	20	520	780	168.00
◇ RGCD18xx-30-500	.53, .75, 1.0, 2.0 gph	30"	500	152.5	21.5	9.8	20	520	780	151.00
◇ RGCD18xx-36-500	.53, .75, 1.0, 2.0 gph	36"	500	152.5	21	9.5	20	520	780	143.00
◇ RGCD18xx-42-500	.53, .75, 1.0, 2.0 gph	42"	500	152.5	20.5	9.3	20	520	780	139.00
◇ RGCD18xx-48-500	.53, .75, 1.0, 2.0 gph	48"	500	152.5	20.5	9.3	20	520	780	134.00
◇ RGCD18xx-54-500	.53, .75, 1.0, 2.0 gph	54"	500	152.5	20.5	9.3	20	520	780	133.00
◇ RGCD18xx-60-500	.53, .75, 1.0, 2.0 gph	60"	500	152.5	20	9.1	20	520	780	129.00
0.710" (20mm OD) Classic Dripline with Rootguard (0.710" ID x 0.805" OD x 0.048" Wall)										
◇ RGCD20xx-12-500	.53, 1.0 gph	12"	500	152.5	26	11.8	18	468	600	292.00
◇ RGCD20xx-18-500	.53, 1.0 gph	18"	500	152.5	26	11.8	18	468	600	237.00
◇ RGCD20xx-24-500	.53, 1.0 gph	24"	500	152.5	25.5	11.6	18	468	600	191.00
◇ RGCD20xx-30-500	.53, 1.0 gph	30"	500	152.5	25	11.3	18	468	600	175.00
◇ RGCD20xx-36-500	.53, 1.0 gph	36"	500	152.5	24.5	11.1	18	468	600	167.00
◇ RGCD20xx-42-500	.53, 1.0 gph	42"	500	152.5	24.5	11.1	18	468	600	160.00
◇ RGCD20xx-48-500	.53, 1.0 gph	48"	500	152.5	24	10.9	18	468	600	156.00
◇ RGCD20xx-54-500	.53, 1.0 gph	54"	500	152.5	24	10.9	18	468	600	154.00
◇ RGCD20xx-60-500	.53, 1.0 gph	60"	500	152.5	24	10.9	18	468	600	149.00

xx Denotes emitter flow rate in gph at 15 psi. Substitute xx, with the flow rate required.

Ordering Information:

- Drip In hose is manufactured I.D. controlled.
- Drip In 0.620" ID (18mm OD) is compatible with 0.620" (16mm) ID Loc Eze Fittings. Please refer to Hose Fittings Section.



Dripline

Drip In® Clipperline™

Drip In® PC Clipperline™ (Category II) Pressure Compensating Dripline with Clips for 14 Gauge Wire

◇ **MADE TO ORDER.** 80,000 Ft. minimum order quantity will apply. Toro Micro-Irrigation Customer Service will confirm by fax that the order has been accepted and the estimated date of delivery.
Flow rate expressed gph per individual emitter @ 30 psi (2 Bar)

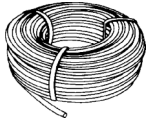

Part Number	Available Flow Rates	Emitter Spacing	Coil Length		Shipping Weight		Coils per Pallet	Coils per Truck Pallet	Coils per Truck Loose	List Price Per Coil
			Ft.	M.	Lbs.	Kilos.				
0.620" (18mm OD) PC Clipperline™ (0.620" ID x 0.710" OD x 0.045" Wall)										
◇ PCS18xx-18C	.42, .53, .75, 1.0 gph	18"	1,000	305	43	19.5	10	260	400	365.00
◇ PCS18xx-24C	.42, .53, .75, 1.0 gph	24"	1,000	305	43	19.5	10	260	400	333.00
◇ PCS18xx-30C	.42, .53, .75, 1.0 gph	30"	1,000	305	41	18.6	10	260	400	296.00
◇ PCS18xx-36C	.42, .53, .75, 1.0 gph	36"	1,000	305	41	18.6	10	260	400	284.00
◇ PCS18xx-42C	.42, .53, .75, 1.0 gph	42"	1,000	305	40	18.1	10	260	400	275.00
◇ PCS18xx-48C	.42, .53, .75, 1.0 gph	48"	1,000	305	40	18.1	10	260	400	267.00
◇ PCS18xx-54C	.42, .53, .75, 1.0 gph	54"	1,000	305	40	18.1	10	260	400	262.00
◇ PCS18xx-60C	.42, .53, .75, 1.0 gph	60"	1,000	305	40	18.1	10	260	400	258.00
0.710" (20mm OD) PC Clipperline™ (0.710" ID x 0.805" OD x 0.048" Wall)										
◇ PCS20xx-18C	.42, .53, .75, 1.0 gph	18"	1,000	305	51	23.1	10	260	380	386.00
◇ PCS20xx-24C	.42, .53, .75, 1.0 gph	24"	1,000	305	51	23.1	10	260	380	353.00
◇ PCS20xx-30C	.42, .53, .75, 1.0 gph	30"	1,000	305	49	22.2	10	260	380	326.00
◇ PCS20xx-36C	.42, .53, .75, 1.0 gph	36"	1,000	305	49	22.2	10	260	380	313.00
◇ PCS20xx-42C	.42, .53, .75, 1.0 gph	42"	1,000	305	48	21.8	10	260	380	305.00
◇ PCS20xx-48C	.42, .53, .75, 1.0 gph	48"	1,000	305	48	21.8	10	260	380	296.00
◇ PCS20xx-54C	.42, .53, .75, 1.0 gph	54"	1,000	305	48	21.8	10	260	380	291.00
◇ PCS20xx-60C	.42, .53, .75, 1.0 gph	60"	1,000	305	48	21.8	10	260	380	286.00

xx Denotes emitter flow rate in gph at 30psi. Substitute xx, with the flow rate required.

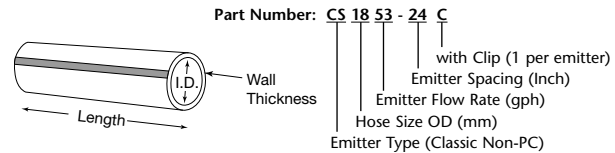

Ordering Information:

- Clips are pre-installed one per emitter, unless otherwise requested!
- Drip In hose is manufactured I.D. controlled.
- Drip In 0.620" ID (18mm OD) is compatible with 0.620" (16mm) ID Loc Eze Fittings. Please refer to Hose Fittings Section.
- Drip In hose is equivalent to:

Drip In 0.550" ID (16mm OD)	EHD1443	Blue Stripe®	Round Hose
Drip In 0.620" ID (18mm OD)	EHD1643	Blue Stripe®	Round Hose
Drip In 0.710" ID (20mm OD)	EHD1845	Blue Stripe®	Round Hose

Dripline

Drip In® Classic

Soakerline Classic (Category II) Non-Pressure Compensating Dripline with the Blue Stripe of Quality

Flow rate expressed gph per individual emitter @ 15 psi (1 Bar)

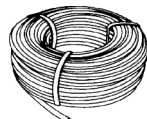

Part Number	Available Flow Rates	Emitter Spacing	Coil Length		Shipping Weight		Coils per Pallet	Coils per Truck Pallet	Coils per Truck Loose	List Price Per Coil
			Ft.	M.	Lbs.	Kilos.				
0.170" (6mm OD) Classic Soaker Dripline (0.170" ID x 0.250" OD x 0.040" Wall) (Coil Banded Pallatized)										
◇ SDS252-6-3000	1/2 gph	6"	3,000	914	39	17.7	20	520	—	1330.00
◇ SDS252-12-3000	1/2 gph	12"	3,000	914	36	16.3	20	520	—	985.00
◇ SDS252-18-3000	1/2 gph	18"	3,000	914	36	16.3	20	520	—	890.00
◇ SDS252-24-3000	1/2 gph	24"	3,000	914	36	16.3	20	520	—	802.00

Ordering Information:

- Drip In hose is manufactured I.D. controlled.
 - Drip In hose is equivalent to:

Drip In Soakerline 0.170" (6mm OD)	EHD0437	Blue Stripe®	Micro-Distribution Hose
------------------------------------	---------	--------------	-------------------------
- ◇ = MADE TO ORDER. Minimum order quantity of 80,000 Ft. will apply. Please consult Toro Micro-Irrigation Customer Service for availability.



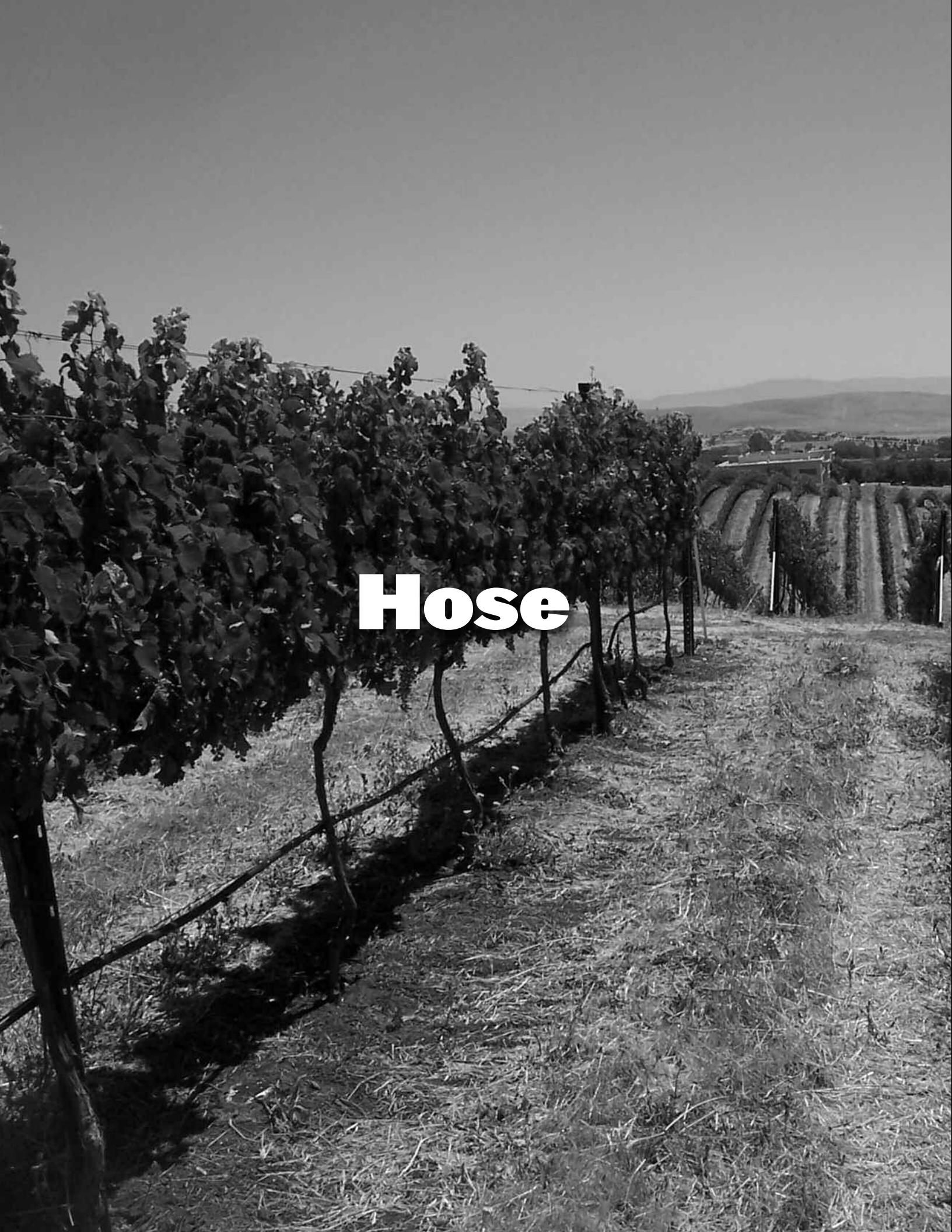

Hose

Hose

Micro-Distribution

Blue Stripe® Micro-Distribution Hose (Category III)

STOCKED ITEMS. PRODUCT GENERALLY AVAILABLE IN STOCK FOR DELIVERY IN APPROXIMATELY 3 WORKING DAYS

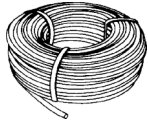

Part Number	Material	Size		Nominal Hose Size			Coil Length		Coil Ship Weight		Coils per		List Price per Coil
		inch	mm	ID inch	OD inch	Wall inch	Ft.	M.	Lbs.	Kilos	Box	Pallet	
Blue Stripe® Micro-Distribution Hose - Coil Stretch Wrapped Palletized													
EHW0437-100	LLDPE	1/4"	4	0.170"	0.250"	0.040"	1,000	305	10.5	4.8	—	60	81.40
EHW0645-050	LLDPE	3/8"	6	0.250"	0.345"	0.047"	500	152	9.0	4.1	—	60	67.20
Blue Stripe® Micro-Distribution Hose - Coil Banded Palletized													
EHD0437-010	LLDPE	1/4"	4	0.170"	0.250"	0.040"	100	30	1.1	0.5	—	250	8.50
EHD0437-300	LLDPE	1/4"	4	0.170"	0.250"	0.040"	3,000	914	31.9	14.5	—	14	165.00
Blue Stripe® Micro-Distribution Hose - Reel Palletized													
EVRO332-100	PEVA	1/8"	3	0.126"	0.196"	0.035"	1,000	305	7.2	3.3	2	100	54.00
EVRO332-250	PEVA	1/8"	3	0.126"	0.196"	0.035"	2,500	762	18.5	8.4	1	50	131.00

Hose

Oval

Blue Stripe® Oval Hose (Category III)

21 PSI WORKING PRESSURE.

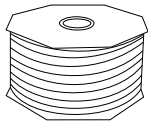

Part Number	Size		Nominal Hose Size		Coil Length		Coil Ship Weight		Coils per Pallet	Coils per Truck		List Price per Coil
	inch	mm	ID inch	Wall inch	Ft.	M.	Lbs.	Kilos		Pallet	Loose	
Reel Palletized												
◇ ELD1334-220	1/2"	13	0.503"	0.034"	2,200	671	51.1	23.2	28	728	—	263.00
Coil Banded Palletized												
◇ ELD2626-166	1"	26	1.043"	0.026"	1,660	506	58.7	26.6	12	312	—	260.00
◇ ELD3550-050	1-1/4"	35	1.365"	0.050"	500	152	60.0	27.2	12	312	—	217.00
◇ ELD4040-060	1-1/2"	40	1.595"	0.040"	600	183	49.9	22.6	12	312	—	237.00
◇ ELD4040-030	1-1/2"	40	1.595"	0.040"	300	91	24.9	11.3	12	312	—	143.00
◇ ELD4040-015	1-1/2"	40	1.595"	0.040"	150	46	17.0	7.7	27	702	—	79.20
◇ ELD5251-015	2"	52	2.052"	0.051"	150	46	20.4	9.3	27	702	—	91.40
◇ ELD5251-045	2"	52	2.052"	0.051"	450	137	72.0	32.7	12	312	—	253.00
◇ ELD7776-020	3"	77	3.043"	0.076"	200	61	67.0	30.4	10	340	—	284.00
◇ ELD101100-013	4"	101	3.996"	0.100"	130	40	71.0	32.2	8	272	—	286.00

Blue Stripe® Oval Hose (Category III)

42 PSI WORKING PRESSURE.

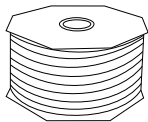

Part Number	Size		Nominal Hose Size		Coil Length		Coil Ship Weight		Coils per Pallet	Coils per Truck		List Price per Coil
	inch	mm	ID inch	Wall inch	Ft.	M.	Lbs.	Kilos		Pallet	Loose	
Reel Palletized												
◇ ELD1634-164	5/8"	16	0.633"	0.034"	1,640	500	47.3	21.5	12	312	—	207.00
Coil Banded Palletized												
◇ ELD2043-120	3/4"	20	0.813"	0.043"	1,200	366	56.1	25.5	12	312	—	240.00
◇ ELD2654-066	1"	26	1.043"	0.054"	660	201	58.0	26.3	12	312	—	208.00
◇ ELD3570-040	1-1/4"	35	1.365"	0.070"	400	122	61.0	27.7	12	312	—	212.00
◇ ELD4084-035	1-1/2"	40	1.595"	0.084"	350	107	72.0	32.7	12	312	—	270.00
◇ ELD52108-025	2"	52	2.052"	0.108"	250	76	76.0	34.5	12	312	—	306.00

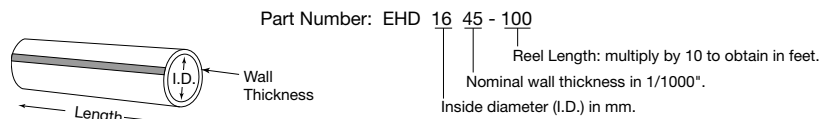

Ordering Information:

◇ = MADE TO ORDER. 80,000 Ft. minimum order quantity will apply. Toro Micro-Irrigation Customer Service will confirm by fax that the order has been accepted and the estimated date of delivery.

- Above hose is manufactured I.D. Controlled, unless otherwise stated.
- Above hose is available Made to Order without a Blue Stripe (i.e. Part No EHDxxxx-xxxNS). Made to Order quantities apply.



Hose

Layflat

Layflat Hose (Category III)

STOCKED ITEMS. PRODUCT GENERALLY AVAILABLE IN STOCK FOR DELIVERY IN APPROXIMATELY 3 WORKING DAYS

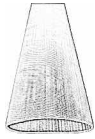

Part Number	Size		Nominal Hose Size		Working Pressure PSI	Coil Length		Coil Ship Weight		Coils per Pallet	Coils per Truck	List Price per Coil
	inch	mm	ID inch	Wall inch		Ft.	M.	Lbs.	Kilos			
SF-10 - Blue Layflat Hose												
SF-10x1.5	1.5"	38	1.61"	0.059"	80	300	91	60.0	27.2	32	672	286.00
SF-10x2.0	2"	51	2.09"	0.059"	80	300	91	73.0	33.1	24	528	314.00
SF-10x3.0	3"	76	3.07"	0.063"	80	300	91	112.0	50.8	20	360	500.00
SF-10x4.0	4"	102	4.13"	0.067"	70	300	91	165.0	74.8	14	245	671.00
SF-10x6.0	6"	152	6.16"	0.075"	45	300	91	285.0	129.3	5	130	1,300.00
SF-10x8.0	8"	203	8.15"	0.087"	40	300	91	400.0	181.4	4	100	2,480.00

Layflat High-Pressure Hose (Category III)

NOT STOCKED. MINIMUM QUANTITIES MAY APPLY

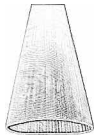

Part Number	Size		Nominal Hose Size		Working Pressure PSI	Coil Length		Coil Ship Weight		Coils per Pallet	Coils per Truck	List Price per Coil
	inch	mm	ID inch	Wall inch		Ft.	M.	Lbs.	Kilos			
SF-55 - Gray Layflat Hose												
SF-55x1.5	1.5"	38	1.61"	0.063	150	300	91	72.0	32.7	16	590	518.00
SF-55x2.0	2"	51	2.080"	0.087	150	300	91	86.0	39.0	13	494	648.00
SF-55x3.0	3"	76	3.07"	0.100	150	300	91	205.0	93.0	10	207	1,320.00
SF-55x4.0	4"	102	4.13"	0.114	100	300	91	327.0	148.3	7	130	1,780.00
SF-55x6.0	6"	152	6.100"	0.146	100	300	91	462.0	209.6	4	92	3,710.00

IPS Tubing - Flexible PVC

NOT STOCKED. MINIMUM QUANTITIES MAY APPLY

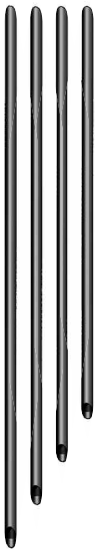
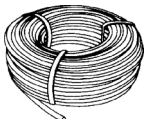

Part Number	Description	Coil Length		Coil/Bundle Weight		Cut length Quantity	Coils per Pallet	List Price Each
		Ft./In.	M.	Lbs.	Kilos			
1/2" IPS Tubing								
IPS50-100	1/2" IPS Tubing, 100' Coil	100'	30.5	20.0	9.1	-	30	85.70
IPS50-200	1/2" IPS Tubing, 200' Coil	200'	61.0	40.0	18.1	-	16	169.00
◇ IPS50-CL12	1/2" IPS Tubing, 12" Cut Length	12"	0.30	5.0	2.3	25	4,500	0.87
◇ IPS50-CL18	1/2" IPS Tubing, 18" Cut Length	18"	0.46	7.5	3.4	25	3,000	1.30
◇ IPS50-CL24	1/2" IPS Tubing, 24" Cut Length	24"	0.61	10.0	4.5	25	2,000	1.72
◇ IPS50-CL30	1/2" IPS Tubing, 30" Cut Length	30"	0.76	12.5	5.7	25	1,500	2.16
◇ IPS50-CL36	1/2" IPS Tubing, 36" Cut Length	36"	0.91	15.0	6.8	25	1,500	2.58
◇ IPS50-CL42	1/2" IPS Tubing, 42" Cut Length	42"	1.07	17.5	7.9	25	1,500	3.03
◇ IPS50-CL48	1/2" IPS Tubing, 48" Cut Length	48"	1.22	20.0	9.1	25	1,500	3.44
◇ IPS50-CL60	1/2" IPS Tubing, 60" Cut Length	60"	1.52	25.0	11.3	25	1,500	4.29
3/4" IPS Tubing								
IPS75-100	3/4" IPS Tubing, 100' Coil	100'	30.5	30.0	13.6	-	20	124.00
IPS75-200	3/4" IPS Tubing, 200' Coil	200'	61.0	60.0	27.2	-	10	237.00
◇ IPS75-CL12	3/4" IPS Tubing, 12" Cut Length	12"	0.30	8.0	3.6	25	3,000	1.24
◇ IPS75-CL18	3/4" IPS Tubing, 18" Cut Length	18"	0.46	12.0	5.4	25	2,000	1.86
◇ IPS75-CL24	3/4" IPS Tubing, 24" Cut Length	24"	0.61	16.0	7.3	25	1,500	2.49
◇ IPS75-CL30	3/4" IPS Tubing, 30" Cut Length	30"	0.76	20.0	9.1	25	1,000	3.09
◇ IPS75-CL36	3/4" IPS Tubing, 36" Cut Length	36"	0.91	24.0	10.9	25	1,000	3.71
◇ IPS75-CL42	3/4" IPS Tubing, 42" Cut Length	42"	1.07	28.0	12.7	25	900	4.33
◇ IPS75-CL48	3/4" IPS Tubing, 48" Cut Length	48"	1.22	32.0	14.5	25	900	4.96
◇ IPS75-CL60	3/4" IPS Tubing, 60" Cut Length	60"	1.52	40.0	18.1	25	900	6.22
1" IPS Tubing								
IPS100-100	1" IPS Tubing, 100' Coil	100'	30.5	41.0	18.6	-	14	172.00
◇ IPS100-200	1" IPS Tubing, 200' Coil	200'	61.0	82.0	37.2	-	10	331.00
◇ IPS100-CL12	1" IPS Tubing, 12" Cut Length	12"	0.30	10.5	4.8	25	1,800	1.72
◇ IPS100-CL18	1" IPS Tubing, 18" Cut Length	18"	0.46	15.8	7.2	25	1,200	2.58
◇ IPS100-CL24	1" IPS Tubing, 24" Cut Length	24"	0.61	21.0	9.5	25	800	3.44
◇ IPS100-CL30	1" IPS Tubing, 30" Cut Length	30"	0.76	26.3	11.9	25	700	4.29
◇ IPS100-CL36	1" IPS Tubing, 36" Cut Length	36"	0.91	31.5	14.3	25	700	5.15
◇ IPS100-CL42	1" IPS Tubing, 42" Cut Length	42"	1.07	36.8	16.7	25	700	6.01
◇ IPS100-CL48	1" IPS Tubing, 48" Cut Length	48"	1.22	42.0	19.1	25	700	6.86
◇ IPS100-CL60	1" IPS Tubing, 60" Cut Length	60"	1.52	52.5	23.8	25	700	8.57

Ordering Information:
◇ = MADE TO ORDER.



Hose

Layflat

Oval Hose and Layflat Fittings (Category VIII)

Part Number	Description	Quantity		Carton Weight		Carton Cube		List Price Each
		Bag	Carton	Lbs.	Kilos	Ft.	M.	
Insert Couplings (Standard)								
C02	2" Insert Couplings	-	50	11.0	5.0	0.694	0.020	2.92
C03	3" Insert Couplings	-	60	30.0	13.6	2.083	0.059	6.90
C04	4" Insert Couplings	-	30	22.0	10.0	2.083	0.059	9.74
C06	6" Insert Couplings	-	13	27.0	12.3	2.558	0.072	33.25
C08	8" Insert Couplings	-	12	48.0	21.8	6.019	0.170	74.29
Insert Tee (Standard)								
T02	2" Insert Tee	-	40	15.0	6.8	7.283	2.220	6.47
T03	3" Insert Tee	-	15	29.0	13.2	9.022	2.750	25.31
T04	4" Insert Tee	-	8	25.0	11.4	7.972	2.430	57.98
T06	6" Insert Tee	-	3	32.0	14.5	19.718	6.010	181.68
T08	8" Insert Tee	-	1	21.0	9.5	13.189	4.020	309.24
Insert Elbow (Standard)								
L02	2" Insert Elbow	-	50	18.0	8.2	7.972	2.430	3.04
L03	3" Insert Elbow	-	20	27.0	12.3	9.022	2.750	19.36
L04	4" Insert Elbow	-	12	25.0	11.4	7.972	2.430	37.18
L06	6" Insert Elbow	-	4	28.0	12.7	9.022	2.750	119.55
L08	8" Insert Elbow	-	2	31.0	14.1	13.189	4.020	226.60
Insert Spigot Adapters (Standard)								
ISP02	2" Insert Spigot Adapters	-	100	25.0	11.4	2.083	0.0590	4.52
ISP03	3" Insert Spigot Adapters	-	50	30.0	13.6	2.083	0.0590	9.39
ISP04	4" Insert Spigot Adapters	-	30	26.0	11.8	2.083	0.0590	11.98
ISP06	6" Insert Spigot Adapters	-	12	28.0	12.7	2.558	0.0724	46.03
ISP08	8" Insert Spigot Adapters	-	12	51.0	23.2	6.019	0.1704	93.98
Insert Slip Adapters (Standard)								
IXS02	2" Insert Slip Adapters	-	120	30.0	13.6	2.083	0.0590	4.78
IXS03	3" Insert Slip Adapters	-	45	31.0	14.1	2.083	0.0590	12.50
IXS04	4" Insert Slip Adapters	-	30	28.0	12.7	2.083	0.0590	13.42
IXS06	6" Insert Slip Adapters	-	14	38.0	17.3	4.181	0.1184	59.21
IXS08	8" Insert Slip Adapters	-	8	33.0	15.0	4.181	0.1184	109.79
Insert Reducers (Standard)								
R32	3"x 2" Insert Reducers	-	60	32.0	14.5	2.083	0.0590	22.96
R43	4"x 3" Insert Reducers	-	60	41.0	18.6	2.558	0.0724	37.61
R64	6"x 4" Insert Reducers	-	6	25.0	11.4	2.164	0.0613	73.92
Insert Male Adapter (Standard)								
MA02	2" Insert Male Adapter	-	-	0.0	0.0	-	-	2.78
MA03	3" Insert Male Adapter	-	50	30.0	13.6	-	-	9.89
MA04	4" Insert Male Adapter	-	30	26.0	11.8	-	-	12.45
MA06	6" Insert Male Adapter	-	12	28.0	12.7	-	-	74.76
MA08	8" Insert Male Adapter	-	6/12	26/52	-	-	-	118.99
Insert Plug (Standard)								
PL02	2" Insert Plug	-	-	0.0	0.0	-	-	4.02
PL03	3" Insert Plug	-	50	30.0	13.6	-	-	14.94
PL04	4" Insert Plug	-	30	27.0	12.3	-	-	16.82
PL06	6" Insert Plug	-	12	30.0	13.6	-	-	72.22
PL08	8" Insert Plug	-	6/12	28/54	-	-	-	150.68
Insert Victaulic Groove (Standard)								
VG02PE	2" Victaulic Groove x Plain End Fitting	-	50	13.0	5.9	-	-	3.78
VG03PE	3" Victaulic Groove x Plain End Fitting	-	48	31.0	14.1	-	-	5.73
VG04PE	4" Victaulic Groove x Plain End Fitting	-	28	25.0	11.4	-	-	8.39
VG06PE	6" Victaulic Groove x Plain End Fitting	-	12	27.0	12.3	-	-	21.79
VG08PE	8" Victaulic Groove x Plain End Fitting	-	6	23.0	10.5	-	-	35.47
VG02IN	2" Victaulic Groove x Insert Barb	-	50	15.0	6.8	-	-	5.98
VG03IN	3" Victaulic Groove x Insert Barb	-	50	31.0	14.1	-	-	12.44
VG04IN	4" Victaulic Groove x Insert Barb	-	30	26.0	11.8	-	-	14.11
VG06IN	6" Victaulic Groove x Insert Barb	-	12	28.0	12.7	-	-	54.44
VG08IN	8" Victaulic Groove x Insert Barb	-	6	26.0	11.8	-	-	101.73



Hose

Round

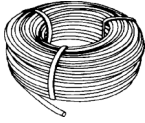

Blue Stripe® Round Hose (Category III)

STOCKED ITEMS. PRODUCT GENERALLY AVAILABLE IN STOCK FOR DELIVERY IN APPROXIMATELY 3 WORKING DAYS

Part Number	Size		Nominal Hose Size		Coil Length		Coil Ship Weight		Coils per			List Price per Coil
	inch	mm	ID inch	Wall inch	Ft.	M.	Lbs.	Kilos	Pallet	Pallet	Truck Loose	
Inside Diameter (ID) Controlled - Coil Stretch Wrapped Palletized												
EHW1554-010	-	15	0.570"	0.054"	100	30	4.5	2.1	72	2,448	—	24.10
EHW1645-010	5/8"	16	0.615"	0.045"	100	30	4.0	1.8	72	2,448	—	22.00
EHW1645-050	5/8"	16	0.615"	0.045"	500	152	19.8	9.0	20	520	—	94.50
Inside Diameter (ID) Controlled - Coil Banded Palletized												
EHD1645-050A	5/8"	16	0.615"	0.045"	500	152	18.9	8.6	20	520	—	68.30
EHD2057-050A	3/4"	20	0.805"	0.057"	500	152	31.2	14.2	12	312	—	113.00
Inside Diameter (ID) Controlled - Coil Banded Loose												
EHD1035-100	-	10	0.390"	0.035"	1,000	305	18.9	8.6	20	520	840	82.30
EHD1335-100	1/2"	13	0.510"	0.035"	1,000	305	24.2	11.0	12	312	720	95.20
EHD1350-050	1/2"	13	0.520"	0.050"	500	152	18.1	8.2	20	520	920	64.50
EHD1350-100	1/2"	13	0.520"	0.050"	1,000	305	36.2	16.4	12	312	720	126.00
EHD1554-050	-	15	0.570"	0.054"	500	152	21.4	9.7	20	520	875	74.60
EHD1554-100	-	15	0.570"	0.054"	1,000	305	42.8	19.4	12	312	590	147.00
EHD1635-100	5/8"	16	0.615"	0.035"	1,000	305	28.9	13.1	12	312	640	108.00
EHD1642-100	5/8"	16	0.625"	0.042"	1,000	305	35.6	16.2	12	312	600	125.00
EHD1643-050	5/8"	16	0.620"	0.043"	500	152	18.5	8.4	20	520	800	66.50
EHD1643-100	5/8"	16	0.620"	0.043"	1,000	305	37.0	16.8	12	312	590	127.00
EHD1845-100	-	18	0.710"	0.045"	1,000	305	43.1	19.6	10	260	500	150.00
EHD1847-100	-	18	0.730"	0.047"	1,000	305	46.4	21.1	10	260	420	158.00
EHD1850-100	-	18	0.720"	0.050"	1,000	305	48.9	22.2	10	260	500	166.00
EHD2052-050	3/4"	20	0.805"	0.052"	500	152	28.3	12.9	12	312	620	95.00
EHD2052-100	3/4"	20	0.805"	0.052"	1,000	305	56.6	25.7	6	204	380	192.00
EHD2657-066	1"	26	1.060"	0.057"	660	201	53.4	24.2	7	182	280	185.00
EHD2662-066	1"	26	1.060"	0.062"	660	201	58.4	26.5	7	182	280	198.00
EHD3580-030	1-1/4"	35	1.365"	0.080"	300	91	44.1	20.0	7	182	315	207.00
Inside Diameter (ID) Controlled - Heavy Wall Hose												
EHD1645-050	5/8"	16	0.615"	0.045"	500	152	18.9	8.6	20	520	800	68.30
EHD1645-100	5/8"	16	0.615"	0.045"	1,000	305	37.8	17.1	12	312	590	131.00
EHD2057-050	3/4"	20	0.805"	0.057"	500	152	31.2	14.2	12	312	620	113.00
EHD2057-100	3/4"	20	0.805"	0.057"	1,000	305	62.5	28.3	6	204	380	210.00
EHD2667-066	1"	26	1.060"	0.067"	660	201	63.3	28.7	7	182	280	212.00

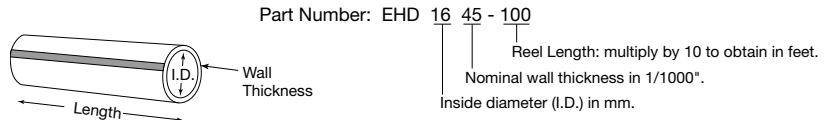

Ordering Information:

- Above hose is available Made to Order without a Blue Stripe (i.e. Part No EHDxxxx-xxxNS). Made to Order quantities apply.
- * Blue Stripe® Round Hose is equivalent to:

EHD1443	Blueline & Drip In 0.550" ID (16mm OD)
EHD1643	Blueline & Drip In 0.620" ID (18mm OD)
EHD1845	Blueline & Drip In 0.710" ID (20mm OD)



Hose

Colored Stripe

Blue Stripe® Round Hose (Category III)

◇ MADE TO ORDER. 80,000 Ft. minimum order quantity will apply. Toro Micro-Irrigation Customer Service will confirm by fax that the order has been accepted and the estimated date of delivery.



Part Number	Size		Nominal Hose Size		Coil Length		Coil Ship Weight		Coils per Pallet	Coils per Truck		List Price per Coil
	inch	mm	ID inch	Wall inch	Ft.	M.	Lbs.	Kilos		Pallet	Loose	
Inside Diameter (ID) Controlled - Coil Stretch Wrapped Palletized												
◇ EHW1554-050	-	15	0.570"	0.054"	500	152	22.7	10.3	20	520	—	98.30
◇ EHW1645-025	5/8"	16	0.620"	0.045"	250	76	9.4	4.3	40	1,040	—	44.40
Inside Diameter (ID) Controlled - Coil Banded Loose												
◇ EHD1038-100	-	10	0.375"	0.038"	1,000	305	20.0	9.1	15	390	840	84.40
◇ EHD1348-100	1/2"	13	0.510"	0.048"	1,000	305	34.0	15.4	20	520	925	122.00
◇ EHD1443-050	-	14	0.550"	0.043"	500	152	16.2	7.4	12	312	680	59.80
◇ EHD1443-100	-	14	0.550"	0.043"	1,000	305	32.4	14.7	12	312	675	117.00
◇ EHD1642-050	5/8"	16	0.625"	0.042"	500	152	17.8	8.1	20	520	800	65.80
◇ EHD1850-050	-	18	0.720"	0.050"	500	152	24.5	11.1	18	300	650	81.80
◇ EHD2662-025	1"	26	1.060"	0.062"	250	76	22.1	10.0	—	—	—	72.70
◇ EHD2667-050	1"	26	1.060"	0.067"	500	152	48.0	21.8	9	234	320	161.00

Colored Striped Round Hose (Category III)

◇ MADE TO ORDER. 80,000 Ft. minimum order quantity will apply. Toro Micro-Irrigation Customer Service will confirm by fax that the order has been accepted and the estimated date of delivery.

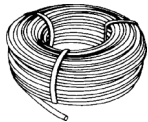

Part Number	Size		Nominal Hose Size		Coil Length		Coil Ship Weight		Coils per Pallet	Coils per Truck		List Price per Coil
	inch	mm	ID inch	Wall inch	Ft.	M.	Lbs.	Kilos		Pallet	Loose	
Purple Stripe Round Hose												
Inside Diameter (ID) Controlled - Coil Banded Loose												
◇ EHP1645-050	5/8"	16	0.615"	0.045"	500							
◇ EHP2057-050	3/4"	20	0.805"	0.057"	500							
White Stripe™ Round Hose												
Inside Diameter (ID) Controlled - Coil Banded Loose												
◇ EHX1645-050	5/8"	16	0.615"	0.045"	500							
◇ EHX2057-050	3/4"	20	0.805"	0.057"	500							

Call Toro Micro-Irrigation Customer Service

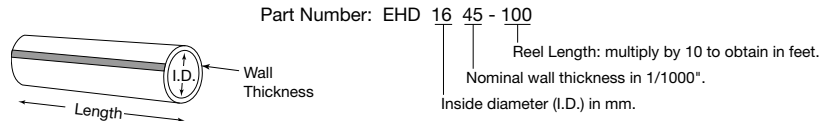

Ordering Information:

• Above hose is available Made to Order without a Blue Stripe (i.e. Part No EHDxxxx-xxxNS). Made to Order quantities apply.

* Blue Stripe® Round Hose is equivalent to:

EHD1443	Blueline & Drip In 0.550" ID (16mm OD)
EHD1643	Blueline & Drip In 0.620" ID (18mm OD)
EHD1845	Blueline & Drip In 0.710" ID (20mm OD)



Hose

Colored Hose

Colored Round Hose (Category III)

◇ **MADE TO ORDER.** 80,000 Ft. minimum order quantity will apply. Toro Micro-Irrigation Customer Service will confirm by fax that the order has been accepted and the estimated date of delivery.

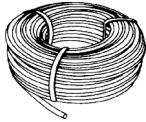

Part Number	Size		Nominal Hose Size		Coil Length		Coil Ship Weight		Coils per Pallet	Coils per Truck		List Price per Coil
	inch	mm	ID inch	Wall inch	Ft.	M.	Lbs.	Kilos		Pallet	Loose	
Purple Round Hose recommended for use with non-potable water applications												
Inside Diameter (ID) Controlled - Coil Banded Loose												
◇ PHD1645-050	5/8"	16	0.615"	0.045"	500	152	19.0	8.6	20	520	760	83.20
◇ PHD1645-100	5/8"	16	0.615"	0.045"	1,000	305	38.0	17.2	12	312	630	161.00
White Round Hose recommended for use in greenhouses, nurseries and hot climates.												
Inside Diameter (ID) Controlled - Coil Banded Loose												
◇ WHD1645-050	5/8"	16	0.615"	0.045"	500	152	18.9	8.6	20	520	760	75.00
◇ WHD1645-100	5/8"	16	0.615"	0.045"	1,000	305	37.8	17.2	12	312	630	144.00
◇ WHD2057-050	3/4"	20	0.805"	0.057"	500	152	31.3	14.2	12	312	620	136.00
◇ WHD2667-066	1"	26	1.060"	0.067"	660	201	63.3	28.7	7	182	260	234.00

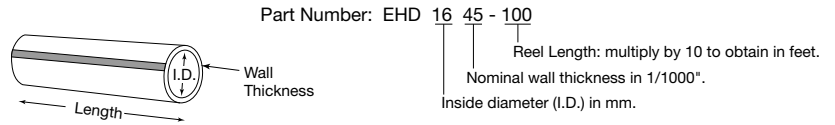

Ordering Information:

- Round Hose (Part No EHDxxxx-xxx) is manufactured I.D. controlled, unless otherwise stated.
- Above hose is available Made to Order without a Blue Stripe (i.e. Part No EHDxxxx-xxxNS). Made to Order quantities apply.

* Blue Stripe® Round Hose is equivalent to:

EHD1443	Blueline & Drip In 0.550" ID (16mm OD)
EHD1643	Blueline & Drip In 0.620" ID (18mm OD)
EHD1845	Blueline & Drip In 0.710" ID (20mm OD)

** Suitable for use with 25mm ISO compression fittings.



Hose

Outside Diameter (OD) Controlled

Blue Stripe® Round Hose (Category III)

◇ MADE TO ORDER. 80,000 Ft. minimum order quantity will apply. Toro Micro-Irrigation Customer Service will confirm by fax that the order has been accepted and the estimated date of delivery.



Part Number	Size		Nominal Hose Size		Coil Length		Coil Ship Weight		Coils per Pallet	Coils per Truck		List Price per Coil
	inch	mm	OD inch	Wall inch	Ft.	M.	Lbs.	Kilos		Pallet	Loose	
Outside Diameter (OD) Controlled - Coil Stretch Wrapped Palletized												
◇ EHW1650-010	5/8"	16	0.700"	0.050"	100	30	4.1	1.9	72	2,448	—	21.70
◇ EHW1650-050	5/8"	16	0.700"	0.050"	500	152	20.7	9.4	20	520	520	97.40
Outside Diameter (OD) Controlled - Coil Banded Palletized												
◇ EHO2055-050A	3/4"	20	0.940"	0.055"	500	152	31.0	14.1	12	312	—	104.00
Outside Diameter (OD) Controlled - Coil Banded Loose												
EHO1650-050	5/8"	16	0.700"	0.050"	500	152	20.5	9.3	20	520	840	72.70
EHO1650-100	5/8"	16	0.700"	0.050"	1,000	305	41.0	18.6	12	312	580	141.00
◇ EHO2050-050	3/4"	20	0.930"	0.050"	500	152	27.9	12.7	12	312	675	94.50
◇ EHO2050-100	3/4"	20	0.930"	0.050"	1,000	305	55.9	25.4	6	204	375	190.00
◇ EHO2055-050	3/4"	20	0.940"	0.055"	500	152	31.0	14.1	12	312	590	104.00
EHO2055-100	3/4"	20	0.940"	0.055"	1,000	305	62.0	28.1	6	204	380	209.00

Colored Round Hose (Category III)

◇ MADE TO ORDER. 80,000 Ft. minimum order quantity will apply. Toro Micro-Irrigation Customer Service will confirm by fax that the order has been accepted and the estimated date of delivery.



Part Number	Size		Nominal Hose Size		Coil Length		Coil Ship Weight		Coils per Pallet	Coils per Truck		List Price per Coil	
	inch	mm	OD inch	Wall inch	Ft.	M.	Lbs.	Kilos		Pallet	Loose		
Outside Diameter (OD) Controlled - Coil Banded Loose													
◇ WHO1650-050	5/8"	16	0.600"	0.700"	0.050"	500	152	20.5	9.3	20	520	840	80.10
◇ WHO1650-100	5/8"	16	0.600"	0.700"	0.050"	1,000	305	41.0	18.6	12	312	580	155.00

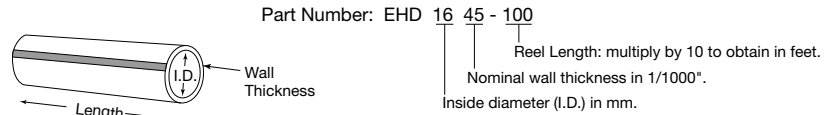

Ordering Information:

◇ = MADE TO ORDER. 80,000 Ft. minimum order quantity will apply. Toro Micro-Irrigation Customer Service will confirm by fax that the order has been accepted and the estimated date of delivery.

- Above hose is manufactured I.D. Controlled, unless otherwise stated.
- Above hose is available Made to Order without a Blue Stripe (i.e. Part No EHDxxx-xxxNS). Made to Order quantities apply.

* Blue Stripe® Round Hose is equivalent to:

EHD1443	BlueLine & Drip In 0.550" ID (16mm OD)
EHD1643	BlueLine & Drip In 0.620" ID (18mm OD)
EHD1845	BlueLine & Drip In 0.710" ID (20mm OD)



Hose

Clipperhose

**Blue Stripe® Clipperhose™ (Category III)
Hose with Clips for 14 Gauge Wire**

◇ **MADE TO ORDER.** 80,000 Ft. minimum order quantity will apply. Toro Micro-Irrigation Customer Service will confirm by fax that the order has been accepted and the estimated date of delivery.



Part Number	Clip		Nominal Hose Size			Coil Length		Coil Ship Weight		Coils per Pallet	Coils per Truck		List Price per Coil
	Spacing inch	Size inch	Size mm	ID inch	Wall inch	Ft.	M.	Lbs.	Kilos		Pallet	Loose	
◇ EHD1643-100-C24	24"	5/8"	16	0.620"	0.043"	1,000	305	44.0	20.0	14	364	520	174.00
◇ EHD1643-100-C30	30"	5/8"	16	0.620"	0.043"	1,000	305	43.7	19.9	14	364	520	160.00
◇ EHD1643-100-C36	36"	5/8"	16	0.620"	0.043"	1,000	305	43.4	19.7	14	364	520	152.00
◇ EHD1645-100-C24	24"	5/8"	16	0.615"	0.045"	1,000	305	45.0	20.5	14	364	520	178.00
◇ EHD1645-100-C30	30"	5/8"	16	0.615"	0.045"	1,000	305	44.7	20.3	14	364	520	165.00
◇ EHD1645-100-C36	36"	5/8"	16	0.615"	0.045"	1,000	305	44.4	20.2	14	364	520	156.00
◇ EHD1845-100-C24	24"	-	18	0.710"	0.045"	1,000	305	49.2	22.4	11	286	500	194.00
◇ EHD1845-100-C30	30"	-	18	0.710"	0.045"	1,000	305	48.9	22.2	11	286	500	181.00
◇ EHD1845-100-C36	36"	-	18	0.710"	0.045"	1,000	305	48.6	22.1	11	286	500	173.00
◇ EHD1847-100-C24	24"	-	18	0.730"	0.047"	1,000	305	50.2	22.8	11	286	500	203.00
◇ EHD1847-100-C30	30"	-	18	0.730"	0.047"	1,000	305	50.2	22.8	11	286	500	191.00
◇ EHD1847-100-C36	36"	-	18	0.730"	0.047"	1,000	305	50.2	22.8	11	286	500	182.00

Hose

Pre-Punched

**Blue Stripe® Pre-Punched Hose (Category III)
Round Hose from 1/2" (13mm) to 1" (26mm) available pre-punched!**

◇ **MADE TO ORDER.** 80,000 Ft. minimum order quantity will apply. Toro Micro-Irrigation Customer Service will confirm by fax that the order has been accepted and the estimated date of delivery.

(To order pre-punched hose, add -P plus the hole spacing in inches to the hose part no. example: EHD1645-100-P24; 5/8" (16mm) hose, pre-punched at 24" spacing.)

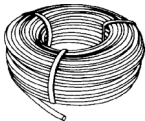

Description	List Price Each
Pre-Punch Price (To be added to the list price of Round Hose)	
Pre-Punch Price for Hole Spacing less than 24" (per 1,000 Ft.)	
Pre-Punch Price for Hole Spacing 24" and above (per 1,000 Ft.)	
Call Toro Micro-Irrigation Customer Service	

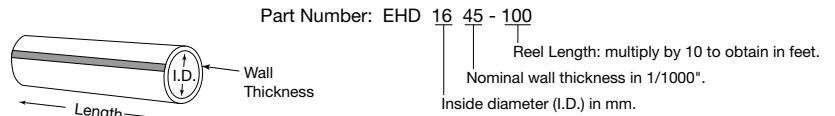

Ordering Information:









- Round Hose (Part No EHDxxxx-xxx) is manufactured I.D. controlled, unless otherwise stated.
- Above hose is available Made to Order without a Blue Stripe (i.e. Part No EHDxxxx-xxxNS). Made to Order quantities apply.
- * Blue Stripe® Round Hose is equivalent to:

EHD1445	Blueline & Drip In 0.550" ID (16mm OD)
EHD1643	Blueline & Drip In 0.620" ID (18mm OD)
EHD1845	Blueline & Drip In 0.710" ID (20mm OD)



Hose & Dripline Fittings

Pro-Loc™ Hose and Dripline Fittings (Category VIII)











Part Number	Description	Quantity		Carton Weight		Carton Cube		List Price Each
		Bag	Carton	Lbs.	Kilos	Ft.	M.	
Couplings								
	FHC500 500 Series Pro-Loc Coupling	50	500	—	—	1.28	0.036	0.61
	FHC600 600 Series Pro-Loc Coupling	50	450	—	—	1.28	0.036	0.67
	FHC700 700 Series Pro-Loc Coupling	50	400	—	—	1.28	0.036	0.82
	FHC800 800 Series Pro-Loc Coupling	50	300	—	—	1.28	0.036	1.09
Threaded Adapters								
	FHA5-50MPT 500 Series Pro-Loc x 1/2" Male Pipe Thread Adapter	50	600	—	—	1.28	0.036	0.60
	FHA6-50MPT 600 Series Pro-Loc x 1/2" Male Pipe Thread Adapter	50	600	—	—	1.28	0.036	0.68
	FHA7-50MPT 700 Series Pro-Loc x 1/2" Male Pipe Thread Adapter	50	500	—	—	1.28	0.036	0.84
	FHA5-75MPT 500 Series Pro-Loc x 3/4" Male Pipe Thread Adapter	50	600	—	—	1.28	0.036	0.60
	FHA6-75MPT 600 Series Pro-Loc x 3/4" Male Pipe Thread Adapter	50	600	—	—	1.28	0.036	0.68
	FHA7-75MPT 700 Series Pro-Loc x 3/4" Male Pipe Thread Adapter	50	450	—	—	1.28	0.036	0.84
	FHA8-75MPT 800 Series Pro-Loc x 3/4" Male Pipe Thread Adapter	50	400	—	—	1.28	0.036	0.95
Threaded Adapters x 3/4" Female Hose Swivel*								
	FHA5-75FHS 500 Ser Pro-Loc x 3/4" Female Hose Swivel	50	400	—	—	1.28	0.036	1.07
	FHA6-75FHS 600 Ser Pro-Loc x 3/4" Female Hose Swivel	50	400	—	—	1.28	0.036	1.09
	FHA7-75FHS 700 Ser Pro-Loc x 3/4" Female Hose Swivel	50	350	—	—	1.28	0.036	1.20
	FHA8-75FHS 800 Ser Pro-Loc x 3/4" Female Hose Swivel	50	350	—	—	1.28	0.036	2.18
Threaded Adapters x 3/4" Female Hose Swivel with Screen*								
	FHA5-75FHSS 500 Ser Pro-Loc x 3/4" Female Hose Swivel with Screen	50	400	—	—	1.28	0.036	1.32
	FHA6-75FHSS 600 Ser Pro-Loc x 3/4" Female Hose Swivel with Screen	50	400	—	—	1.28	0.036	1.36
	FHA7-75FHSS 700 Ser Pro-Loc x 3/4" Female Hose Swivel with Screen	50	350	—	—	1.28	0.036	1.43
	FHA8-75FHSS 800 Ser Pro-Loc x 3/4" Female Hose Swivel with Screen	50	350	—	—	1.28	0.036	2.35
Barbed Adapters with Rubber Grommet								
	FHA5-425RG 500 Series Pro-Loc x 425 Series Barb with Rubber Grommet	100	800	—	—	1.28	0.036	0.68
	FHA6-425RG 600 Series Pro-Loc x 425 Series Barb with Rubber Grommet	100	600	—	—	1.28	0.036	0.79
	FHA7-425RG 700 Series Pro-Loc x 425 Series Barb with Rubber Grommet	100	400	—	—	1.28	0.036	0.88
	FHA8-425RG 800 Series Pro-Loc x 425 Series Barb with Rubber Grommet	100	400	—	—	1.28	0.036	1.12
Layflat Takeoffs								
	FHA5-LF 500 Series Pro-Loc x Layflat Takeoff Single Grip	—	400	—	—	1.28	0.036	1.25
	FHA6-LF 600 Series Pro-Loc x Layflat Takeoff Single Grip	—	400	—	—	1.28	0.036	1.33
	FHA7-LF 700 Series Pro-Loc x Layflat Takeoff Single Grip	—	400	—	—	1.28	0.036	1.51
	FHA5-LF2 500 Series Pro-Loc x Layflat Takeoff Double Grip	50	400	—	—	1.28	0.036	1.76
Elbows								
	FHE500 500 Series Pro-Loc Elbow	50	450	—	—	1.28	0.036	1.41
	FHE600 600 Series Pro-Loc Elbow	50	300	—	—	1.28	0.036	1.68
	FHE700 700 Series Pro-Loc Elbow	50	300	—	—	1.28	0.036	1.95
	FHE800 800 Series Pro-Loc Elbow	—	400	—	—	1.28	0.036	2.12
Tees								
	FHT500 500 Series Pro-Loc Tee	50	300	—	—	1.28	0.036	1.50
	FHT600 600 Series Pro-Loc Tee	50	250	—	—	1.28	0.036	1.77
	FHT700 700 Series Pro-Loc Tee	50	200	—	—	1.28	0.036	2.14
	FHT800 800 Series Pro-Loc Tee	50	150	—	—	1.28	0.036	2.73
Tee x 3/4" Male Pipe Thread								
	FHT5-75MPT 500 Series Pro-Loc Tee x 3/4" Male Pipe Thread	50	250	—	—	1.28	0.036	1.62
	FHT6-75MPT 600 Series Pro-Loc Tee x 3/4" Male Pipe Thread	50	250	—	—	1.28	0.036	1.80
	FHT7-75MPT 700 Series Pro-Loc Tee x 3/4" Male Pipe Thread	50	200	—	—	1.28	0.036	1.95

Note: *All Swivels are assembled with a washer. Screen option is also available.



Hose & Dripline Fittings

Pro-Loc™ Hose and Dripline Fittings (Category VIII)



Part Number	Description	Quantity		Carton Weight		Carton Cube		List Price Each	
		Bag	Carton	Lbs.	Kilos	Ft.	M.		
Tees x 3/4" Female Hose Swivel*									
	FHT5-75FHS	500 Ser Pro-Loc Tee x 3/4" Female Hose Swivel	50	250	—	—	1.28	0.036	1.75
	FHT6-75FHS	600 Ser Pro-Loc Tee x 3/4" Female Hose Swivel	50	250	—	—	1.28	0.036	1.81
	FHT7-75FHS	700 Ser Pro-Loc Tee x 3/4" Female Hose Swivel	50	200	—	—	1.28	0.036	1.92
	FHT8-75FHS	800 Ser Pro-Loc Tee x 3/4" Female Hose Swivel	40	160	—	—	1.28	0.036	3.01
Tees x 3/4" Female Hose Swivel with Screen*									
	FHT5-75FHSS	500 Ser Pro-Loc Tee x 3/4" Female Hose Swivel with Screen	50	250	—	—	1.28	0.036	1.91
	FHT6-75FHSS	600 Ser Pro-Loc Tee x 3/4" Female Hose Swivel with Screen	50	250	—	—	1.28	0.036	1.98
	FHT7-75FHSS	700 Ser Pro-Loc Tee x 3/4" Female Hose Swivel with Screen	50	200	—	—	1.28	0.036	2.18
	FHT8-75FHSS	800 Ser Pro-Loc Tee x 3/4" Female Hose Swivel with Screen	40	160	—	—	1.28	0.036	3.27
Shutoff Valves									
	FHV500	500 Series Pro-Loc Shutoff Valve	100	300	—	—	1.28	0.036	1.42
	FHV600	600 Series Pro-Loc Shutoff Valve	—	400	—	—	1.28	0.036	1.42
Shutoff Valves x 250 Series Barb Adapter									
	FHV6-250B	600 Series Pro-Loc x 250 Series Barb Shutoff Valve	50	—	—	—	1.28	0.036	1.75
Shutoff Valves with Rubber Grommet									
	FHV6-425G	600 Series Pro-Loc x 425 Series Barb Shutoff Valve with Grommet	50	350	—	—	1.28	0.036	1.53
Male Thread Shutoff Valves									
	FHV5-50MPT	500 Series Pro-Loc x 1/2" Male Pipe Thread Shutoff Valve	50	400	—	—	1.28	0.036	1.48
	FHV6-50MPT	600 Series Pro-Loc x 1/2" Male Pipe Thread Shutoff Valve	—	400	—	—	1.28	0.036	1.48
	FHV5-75MPT	500 Series Pro-Loc x 3/4" Male Pipe Thread Shutoff Valve	50	300	—	—	1.28	0.036	1.48
	FHV6-75MPT	600 Series Pro-Loc x 3/4" Male Pipe Thread Shutoff Valve	—	400	—	—	1.28	0.036	1.48
Male Hose Thread x Female Hose Thread Shutoff Valves									
	FHV75MHT-75FHS	3/4" Male Hose Thread x 3/4" Female Hose Swivel with Shutoff Valve	50	250	—	—	1.28	0.036	2.18
Layflat Installation Tools									
	LF-INST	T-Handle Hex Tool for Layflat Installation	25	250	—	—	1.28	0.036	5.40
	LF-CUT14	Layflat Cutter - 14mm	1	50	23.33	10.60	1.28	0.036	91.80
	LF-CUT16	Layflat Cutter - 16mm	1	50	23.33	10.60	1.28	0.036	91.80
	LF-CUT19	Layflat Cutter - 19mm	1	50	23.33	10.60	1.28	0.036	106.00
400 Series Barb Tools									
	INS-400XS	400B Cutting and Inserting Tool - Extra Short	10	80	25.43	11.56	1.28	0.036	29.70
	INS-400S	400B Cutting and Inserting Tool - Short	10	80	25.43	11.56	1.28	0.036	29.70
	INS-400AS	400B Cutting and Inserting Tool with Adjustable Tip - Short	10	80	25.43	11.56	1.28	0.036	42.40
	INS-400AL	400B Cutting and Inserting Tool with Adjustable Tip - Long	10	80	25.43	11.56	1.28	0.036	42.40
	TIP-400XS	400B Replacement Tip - Extra Short	27	216	25.43	11.56	1.28	0.036	23.30
	TIP-400S	400B Replacement Tip - Short	27	216	25.43	11.56	1.28	0.036	23.30
	TIP-400AS	400B Replacement Adjustable Tip - Short	27	216	25.43	11.56	1.28	0.036	35.30
	TIP-400AL	400B Replacement Adjustable Tip - Long	24	192	25.43	11.56	1.28	0.036	35.30

Note: *All Swivels are assembled with a washer. Screen option is also available.

Pro-Loc™ Fittings Selection Chart					
Nominal Size	Series Number	Inside Diameter Tolerance		Wall Thickness Tolerance	
		Inches	Millimeters	Inches	Millimeters
16mm & 17mm	500	0.519 - 0.590	13.2 - 15.0	0.020 - 0.055	0.50 - 1.40
18mm	600	0.598 - 0.649	15.2 - 16.5	0.030 - 0.055	0.75 - 1.40
20mm	700	0.677 - 0.728	17.2 - 18.5	0.032 - 0.055	0.80 - 1.40
22mm	800	0.787 - 0.846	20.0 - 21.5	0.040 - 0.059	1.00 - 1.50

Hose & Dripline Fittings

Barbed Hose Fittings (Category VIII)









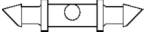

Part Number	Description	Quantity		Carton Weight		Carton Cube		List Price Each	
		Bag	Carton	Lbs.	Kilos	Ft.	M.		
Barbed Couplings									
	FBC400B	400 Series Barb Coupling	500	1500	—	—	1.28	0.036	0.30
	FBC500	500 Series Barb Coupling	500	1,500	—	—	1.28	0.036	0.13
	FBC700	700 Series Barb Coupling	200	1,000	—	—	1.28	0.036	0.17
	FBC1000	1000 Series Barb Coupling	100	500	—	—	1.28	0.036	0.31
Barbed Tees									
	FBT500	500 Series Barb Tee	250	1,000	—	—	1.28	0.036	0.17
	FBT700	700 Series Barb Tee	50	400	—	—	1.28	0.036	0.42
	FBT1000	1000 Series Barb Tee	40	200	—	—	1.28	0.036	0.72
Male Thread Adapters									
	FBA5-50MPT	500 Series Barb x 1/2" Male Pipe Thread Adapter	100	1,200	—	—	1.28	0.036	0.29
	FBA7-50MPT	700 Series Barb x 1/2" Male Pipe Thread Adapter	100	1,000	—	—	1.28	0.036	0.31
	FBA10-50MPT	1000 Series Barb x 1/2" Male Pipe Thread Adapter	100	700	—	—	1.28	0.036	0.40
	FBA5-75MPT	500 Series Barb x 3/4" Male Pipe Thread Adapter	100	700	—	—	1.28	0.036	0.29
	FBA7-75MPT	700 Series Barb x 3/4" Male Pipe Thread Adapter	100	700	—	—	1.28	0.036	0.31
	FBA10-75MPT	1000 Series Barb x 3/4" Male Pipe Thread Adapter	100	500	—	—	1.28	0.036	0.40

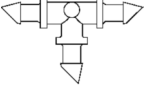
Nominal Size	Series Number	Inside Diameter	
		Inches	Millimeters
16 & 17mm	500	0.519	13.2
20mm	700	0.661	16.8
25mm	1000	0.850	21.6
32mm	1200	1.110	28.2
40mm	1400	1.385	35.2

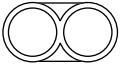
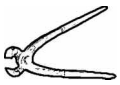

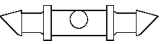
Hose & Dripline Fittings

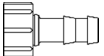
Barbed Hose Fittings & Accessories (Category VIII)

Part Number	Description	Quantity		Carton Weight		Carton Cube		List Price Each
		Bag	Carton	Lbs.	Kilos	Ft.	M.	
Coupling, (ID) Barb X (ID) Barb								
 FCC0400	0.170" (4mm) ID Barbed Coupling	500	10,000	24.0	11	1	0.038	0.03
FCC0400-100	0.170" (4mm) ID Barbed Coupling	100	10,000	24.0	11	1	0.038	0.03
Elbow, (ID) Barb X (ID) Barb								
 FEE0400	0.170" (4mm) ID Barbed Elbow	500	10,000	16.0	7	1	0.038	0.06
FEE0400-100	0.170" (4mm) ID Barbed Elbow	100	10,000	16.0	7	1	0.038	0.06
FEE1500	0.570" (15mm) ID Barbed Elbow	100	900	16.0	7	1	0.038	0.39
Tee, (ID) Barb X (ID) Barb X (ID) Barb								
 FTT0400	0.170" (4mm) ID Barbed Tee	500	10,000	23.0	10	1	0.038	0.06
FTT0400-100	0.170" (4mm) ID Barbed Tee	100	10,000	23.0	10	1	0.038	0.06
FTT1500	0.570" (15mm) ID Barbed Tee	100	500	11.0	5	1	0.038	0.32
Goof Plugs								
 FPG01	Single side hose plug	1,200	18,000	12.0	5	1	0.038	0.02
FPG02	Dual side hose plug	100	10,000	12.0	5	1	0.038	0.08
FPG06	Goof Plug - 6mm	1,000	35,000	—	—	1.28	0.036	0.04
FPG08	Goof Plug - 8mm	1,000	25,000	—	—	1.28	0.036	0.06
FPG10	Goof Plug - 10mm	1,000	16,000	—	—	1.28	0.036	0.06
FPG12	Goof Plug - 12mm	1,000	8,000	—	—	1.28	0.036	0.08
Figure 8 End Clamp								
 FJQ13	13mm figure 8 end clamp	100	2,000	12.0	5	1	0.038	0.17
FJQ16	16mm figure 8 end clamp	100	1,600	12.0	5	1	0.038	0.18
FJQ20	20mm figure 8 end clamp	—	1,000	14.0	6	1	0.028	0.39
FJQ26	26mm figure 8 end clamp	—	1,000	18.0	8	2	0.042	0.39
Oetiker 1-Ear Clamps								
 WFL0040	(198R) Nominal Size 3/4", Closed .618", Open .779"	100	5,000	29.0	13	1	0.021	0.30
WFL0042	(210R) Nominal Size 13/16", Closed .716", Open .827"	100	4,000	20.0	9	1	0.021	0.25
WFL0043	(256R) Nominal Size 1", Closed .898, Open 1.008"	100	4,500	30.0	14	1	0.031	0.27
WFL0044	(316R) Nominal Size 1 1/4", Closed 1.122", Open 1.244"	100	6,000	24.0	11	1	0.031	0.30
WFL0045	(1098) Straight Jaw Pliers	1	10	—	—	—	—	41.70
Bug Cap for 1/4" (4mm) Tubing								
 BC-025	Bug Cap for 1/4" (4mm) Tubing	25	—	—	—	—	—	0.25
Micro Flow Valve, (ID) Barb x (ID) Barb								
 FCV-BB	0.170" (4mm) ID Barbed Valve	5	—	—	—	1.35	0.038	1.00
Coupling, (ID) Barb X (ID) Barb								
 FCC0400	0.170" (4mm) ID Barbed Coupling	500	10,000	24.0	10.9	1.35	0.038	0.03
FCC0400-100	0.170" (4mm) ID Barbed Coupling	100	10,000	24.0	10.9	1.35	0.038	0.03
FCC0600	0.250" (6mm) ID Barbed Coupling	500	5,000	—	—	1.35	0.038	0.33
FCC1500	0.570" (15mm) ID Barbed Coupling	100	1,500	16.0	7.3	1.35	0.038	0.24
Coupling, (ID) Barb X (ID) Barb (with Safety Loc Ring)								
 FCC1400-1	0.550" (14mm) ID Barbed Coupling (Dark Green Ring)	100	4,200	25.0	11.3	1.35	0.038	0.23
FCC1600-1	0.620" (16mm) ID Barbed Coupling (Blue Ring)	100	3,000	25.0	11.3	1.35	0.038	0.59
FCC1800-1	0.710" (18mm) ID Barbed Coupling (Light Green Ring)	100	2,500	25.0	11.3	1.35	0.038	0.54
Male Adapter, (ID) Barb x 1/2" MPT								
 FAM1500	0.570" (15mm) ID Barb x 1/2" MPT Adapter w/out cap	100	1,000	15.0	6.8	1.35	0.038	0.23
Female Adapter, (ID) Barb x 3/4" FHT Swivel								
 FAS1500	0.570" (15mm) ID Barb x 3/4" FHT Swivel Adapter w/screen	100	700	23.0	10.4	1.35	0.038	0.85
FAS1500-1	0.570" (15mm) ID Barb x 3/4" FHT Swivel Adapter w/washer	100	700	23.0	10.4	1.35	0.038	0.60
Adapter Tee, (ID) Barb x (ID) Barb x 3/4" FHT Swivel								
 FTS1500	0.570" (15mm) ID Barb x 3/4" FHT Swivel Tee w/screen	100	400	24.0	10.9	1.35	0.038	1.44
FTS1500-1	0.570" (15mm) ID Barb x 3/4" FHT Swivel Tee w/washer	100	400	24.0	10.9	1.35	0.038	1.19
Hose End, (ID) Barb x 3/4" MHT								
 FJA1500	0.570" (15mm) ID Barb x 3/4" MHT w/out cap	100	800	22.0	10.0	1.35	0.038	0.25
FJJ1500	0.570" (15mm) ID Barb x 3/4" MHT with cap	100	800	25.0	11.3	1.35	0.038	0.66



Hose & Dripline Fittings

Oval Hose and Layflat Fittings (Category VIII)

Part Number	Description	Quantity		Carton Weight		Carton Cube		List Price Each
		Bag	Carton	Lbs.	Kilos	Ft.	M.	
Insert Couplings (Standard)								
C02	2" Insert Couplings	-	50	11.0	5.0	0.694	0.020	2.92
C03	3" Insert Couplings	-	60	30.0	13.6	2.083	0.059	6.90
C04	4" Insert Couplings	-	30	22.0	10.0	2.083	0.059	9.74
C06	6" Insert Couplings	-	13	27.0	12.3	2.558	0.072	33.25
C08	8" Insert Couplings	-	12	48.0	21.8	6.019	0.170	74.29
Insert Tee (Standard)								
T02	2" Insert Tee	-	40	15.0	6.8	7.283	2.220	6.47
T03	3" Insert Tee	-	15	29.0	13.2	9.022	2.750	25.31
T04	4" Insert Tee	-	8	25.0	11.4	7.972	2.430	57.98
T06	6" Insert Tee	-	3	32.0	14.5	19.718	6.010	181.68
T08	8" Insert Tee	-	1	21.0	9.5	13.189	4.020	309.24
Insert Elbow (Standard)								
L02	2" Insert Elbow	-	50	18.0	8.2	7.972	2.430	3.04
L03	3" Insert Elbow	-	20	27.0	12.3	9.022	2.750	19.36
L04	4" Insert Elbow	-	12	25.0	11.4	7.972	2.430	37.18
L06	6" Insert Elbow	-	4	28.0	12.7	9.022	2.750	119.55
L08	8" Insert Elbow	-	2	31.0	14.1	13.189	4.020	226.60
Insert Spigot Adapters (Standard)								
ISP02	2" Insert Spigot Adapters	-	100	25.0	11.4	2.083	0.0590	4.52
ISP03	3" Insert Spigot Adapters	-	50	30.0	13.6	2.083	0.0590	9.39
ISP04	4" Insert Spigot Adapters	-	30	26.0	11.8	2.083	0.0590	11.98
ISP06	6" Insert Spigot Adapters	-	12	28.0	12.7	2.558	0.0724	46.03
ISP08	8" Insert Spigot Adapters	-	12	51.0	23.2	6.019	0.1704	93.98
Insert Slip Adapters (Standard)								
IXS02	2" Insert Slip Adapters	-	120	30.0	13.6	2.083	0.0590	4.78
IXS03	3" Insert Slip Adapters	-	45	31.0	14.1	2.083	0.0590	12.50
IXS04	4" Insert Slip Adapters	-	30	28.0	12.7	2.083	0.0590	13.42
IXS06	6" Insert Slip Adapters	-	14	38.0	17.3	4.181	0.1184	59.21
IXS08	8" Insert Slip Adapters	-	8	33.0	15.0	4.181	0.1184	109.79
Insert Reducers (Standard)								
R32	3"x 2" Insert Reducers	-	60	32.0	14.5	2.083	0.0590	22.96
R43	4"x 3" Insert Reducers	-	60	41.0	18.6	2.558	0.0724	37.61
R64	6"x 4" Insert Reducers	-	6	25.0	11.4	2.164	0.0613	73.92
Insert Male Adapter (Standard)								
MA02	2" Insert Male Adapter	-	-	0.0	0.0	-	-	2.78
MA03	3" Insert Male Adapter	-	50	30.0	13.6	-	-	9.89
MA04	4" Insert Male Adapter	-	30	26.0	11.8	-	-	12.45
MA06	6" Insert Male Adapter	-	12	28.0	12.7	-	-	74.76
MA08	8" Insert Male Adapter	-	6/12	26/52	-	-	-	118.99
Insert Plug (Standard)								
PL02	2" Insert Plug	-	-	0.0	0.0	-	-	4.02
PL03	3" Insert Plug	-	50	30.0	13.6	-	-	14.94
PL04	4" Insert Plug	-	30	27.0	12.3	-	-	16.82
PL06	6" Insert Plug	-	12	30.0	13.6	-	-	72.22
PL08	8" Insert Plug	-	6/12	28/54	-	-	-	150.68
Insert Victaulic Groove (Standard)								
VG02PE	2" Victaulic Groove x Plain End Fitting	-	50	13.0	5.9	-	-	3.78
VG03PE	3" Victaulic Groove x Plain End Fitting	-	48	31.0	14.1	-	-	5.73
VG04PE	4" Victaulic Groove x Plain End Fitting	-	28	25.0	11.4	-	-	8.39
VG06PE	6" Victaulic Groove x Plain End Fitting	-	12	27.0	12.3	-	-	21.79
VG08PE	8" Victaulic Groove x Plain End Fitting	-	6	23.0	10.5	-	-	35.47
VG02IN	2" Victaulic Groove x Insert Barb	-	50	15.0	6.8	-	-	5.98
VG03IN	2" Victaulic Groove x Insert Barb	-	50	31.0	14.1	-	-	12.44
VG04IN	2" Victaulic Groove x Insert Barb	-	30	26.0	11.8	-	-	14.11
VG06IN	2" Victaulic Groove x Insert Barb	-	12	28.0	12.7	-	-	54.44
VG08IN	2" Victaulic Groove x Insert Barb	-	6	26.0	11.8	-	-	101.73



Hose & Dripline Fittings

Oval Hose and Layflat Clamps (Category VIII)



Part Number	Description	Quantity		Carton Weight		Carton Cube		List Price Each
		Bag	Carton	Lbs.	Kilos	Ft.	M.	
Worm Gear Clamps, Stainless Steel								
Clamp1.5	1.5" Worm Gear Clamp, Stainless Steel	-	400	23.4	10.6	1.03	0.314	0.83
Clamp2	2.0" Worm Gear Clamp, Stainless Steel	-	400	23.4	10.6	1.03	0.314	0.96
Clamp3	3.0" Worm Gear Clamp, Stainless Steel	-	300	21.2	9.6	1.41	0.431	1.17
Clamp4	4.0" Worm Gear Clamp, Stainless Steel	-	200	16.0	7.3	1.36	0.414	1.27
Clamp6	6.0" Worm Gear Clamp, Stainless Steel	-	100	11.5	5.2	1.64	0.499	1.54
Clamp8	8.0" Worm Gear Clamp, Stainless Steel	-	100	13.4	6.1	0.65	0.197	2.67

Take-off Fittings for PVC (Category VIII)



Part Number	Description	Quantity		Carton Weight		Carton Cube		List Price Each
		Carton		Lbs.	Kilos	Ft.	M.	
Take-off Adaptors								
XP-13x13	13 mm grommet inlet x 13mm takeoff	1,600		18.0	8.16	—	—	0.59
XP-13x14	13 mm grommet inlet x 14mm takeoff	1,600		22.0	9.98	—	—	0.61
XP-13x15	13 mm grommet inlet x 15 mm takeoff	1,400		21.0	9.53	—	—	0.66
XP-16x16	16 mm grommet inlet x 16 mm takeoff	1,000		18.0	8.16	—	—	0.90
XP-16x18	16 mm grommet inlet x 18 mm takeoff	1,000		22.0	9.98	—	—	0.91
XP-19x21	19 mm grommet inlet x 21 mm takeoff	—		—	—	—	—	1.09



Rubber Grommets								
CAP-13	Rubber Grommet 13mm	5,500		23.0	10.43	—	—	0.54
CAP-16	Rubber Grommet 16mm	2,700		23.0	10.43	—	—	0.68
CAP-19	Rubber Grommet 19mm	1,000		23.0	10.43	—	—	0.79



Wedge Plug								
FTC10	10mm Wedge Plug, PVC drill size 15/32", poly drill size 29/64", min PVC size 3/4" 20mm	100	5,000	18.0	8.2	1.35	0.038	0.12
FTC13	13mm Wedge Plug, PVC drill size 19/32", poly drill size 37/64", min PVC size 1" 25mm	100	3,000	18.0	8.2	1.35	0.038	0.21
FTC16	16mm Wedge Plug, PVC drill size 23/32", poly drill size 45/64", min PVC size 1-1/4" 32mm	100	2,200	18.0	8.2	1.35	0.038	0.42

Hose Fittings, Loc-Eze® (Category VIII)

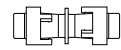

Part Number	Description	Quantity		Carton Weight		Carton Cube		List Price Each
		Bag	Carton	Lbs.	Kilos	Ft.	M.	
Coupling, (ID) Loc-Eze X (ID) Loc-Eze								
FCC13	0.510" (13mm) ID Loc-Eze Coupling	100	1,400	24.0	10.9	1.35	0.038	0.51
FCC15	0.570" (15mm) ID Loc-Eze Coupling	100	1,000	25.0	11.3	1.35	0.038	0.83
FCC16	0.620" (16mm) ID Loc-Eze Coupling	100	1,000	25.0	11.3	1.35	0.038	0.45



Elbow, (ID) Loc-Eze X (ID) Loc-Eze								
FEE13	0.510" (13mm) ID Loc-Eze Elbow	100	1,200	25.0	11.3	1.35	0.038	0.94
FEE16	0.620" (16mm) ID Loc-Eze Elbow	100	700	21.0	9.5	1.35	0.038	0.75

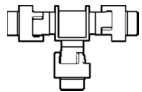

Tee, (ID) Loc-Eze X (ID) Loc-Eze X (ID) Loc-Eze								
FTT13	0.510" (13mm) ID Loc-Eze Tee	100	600	19.0	8.6	1.35	0.038	0.95
FTT16	0.620" (16mm) ID Loc-Eze Tee	100	500	23.0	10.4	1.35	0.038	0.72

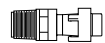

Male Adapter, (ID) Loc-Eze X 1/2" MPT								
FAM13	0.510" (13mm) ID Loc-Eze x 1/2" MPT Adapter w/out cap	100	1,400	17.0	7.7	1.35	0.038	0.21
FAM16	0.620" (16mm) ID Loc-Eze x 1/2" MPT Adapter w/out cap	100	900	22.0	10.0	1.35	0.038	0.30

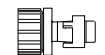

Hose End, (ID) Loc-Eze X 3/4" MHT								
FJA16	0.620" (16mm) ID Loc-Eze x 3/4" MHT Hose End w/out cap	100	800	24.0	10.9	1.35	0.038	0.63
FJJ16	0.620" (16mm) ID Loc-Eze x 3/4" MHT Hose End with cap	100	600	30.0	13.6	1.35	0.038	0.88

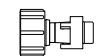

Female Adapter, (ID) Loc-Eze X 3/4" FHT Swivel								
FAS16	0.620" (16mm) ID Loc-Eze x 3/4" FHT Swivel Adapter w/screen	100	700	26.0	11.8	1.35	0.038	1.25
FAS16-1	0.620" (16mm) ID Loc-Eze x 3/4" FHT Swivel Adapter w/washer	100	700	26.0	11.8	1.35	0.038	1.47

Ordering Information:

◇ = MADE TO ORDER. Minimum order quantity will apply. Please consult Toro Micro-Irrigation Customer Service for availability.

Shaded area indicates products being discontinued. Limited to available stocks on hand.

Hose & Dripline Fittings

Hose Fittings, Loc-Eze® & Accessories (Category VIII)

Part Number	Description	Quantity		Carton Weight		Carton Cube		List Price Each
		Bag	Carton	Lbs.	Kilos	Ft.	M.	
Adapter Tee, (ID) Loc-Eze X (ID) Loc-Eze X 1/2" Slip								
FTV16	0.620" (16mm) ID Loc-Eze x 1/2" Slip Tee	100	400	21.0	9.5	1.35	0.038	0.92
Adapter Tee, (ID) Loc-Eze X (ID) Loc-Eze X 1/2" FPT								
FTF16	0.620" (16mm) ID Loc-Eze x 1/2" FPT Tee	100	400	22.0	10.0	1.35	0.038	1.02
Adapter Tee, (ID) Loc-Eze X (ID) Loc-Eze X 3/4" FHT Swivel								
FTS13	0.510" (13mm) ID Loc-Eze x 3/4" FHT Swivel Tee w/screen	100	400	22.0	10.0	1.35	0.038	2.58
FTS16	0.620" (16mm) ID Loc-Eze x 3/4" FHT Swivel Tee w/screen	100	400	27.0	12.2	1.35	0.038	1.98
FTS16-1	0.620" (16mm) ID Loc-Eze x 3/4" FHT Swivel Tee w/washer	100	400	27.0	12.2	1.35	0.038	1.69
Oval Hose Connector, 7mm Barb X Hose (ID) Loc-Eze								
FCA0710	7mm barb x 10mm Loc-Eze	100	2,500	28.0	12.7	1.35	0.038	0.66
FCA0713	7mm barb x 13mm Loc-Eze	100	2,500	28.0	12.7	1.35	0.038	0.59
FCA0716	7mm barb x 16mm Loc-Eze	100	1,500	25.0	11.3	1.35	0.038	0.44
FEP3559	7mm barb x 16mm w/out ring	—	2,000	27.0	12.2	1.35	0.038	0.24
Rubber Grommet, takeoff for PVC X 7mm Barb								
FGP10	Rubber Grommet for 7mm Barb (for use with FCA fittings), use drill bit size 9/16"	—	5,000	22.0	10.0	0.92	0.026	0.67

Clip Rings for Clipperhose™ (Category VIII)

Part Number	Description	Quantity		Carton Weight		Carton Cube		List Price Each
		Bag	Carton	Lbs.	Kilos	Ft.	M.	
Clip Rings for Clipperhose™ (suitable for 14 Gauge Wire)								
CLPAG18	0.710" ~ 0.720" OD (18mm OD) Clip Ring	—	5,000	30.0	13.7	1.57	0.044	0.09
CLPAG20	0.805" ~ 0.830" OD (20mm OD) Clip Ring	—	5,000	24.0	10.9	1.57	0.044	0.10

H-Curls (Category VIII)





Part Number	Description Nominal size hose	Quantity		Carton Weight		Carton Cube		List Price per 1,000
		Carton	Gaylord	Lbs.	Kilos	Ft.	M.	
H-Curls (Carton Quantities)								
HC13-3.0-1000	13mm X 3" long for hose 0.640" to 0.720" OD.	1,000	—	12.0	6	1	0.038	48.40
HC13-4.0-1000	13mm X 4" long for hose 0.680" to 0.760" OD.	1,000	—	13.0	6	1	0.038	64.40
HC16-3.0-1000	16mm X 3" long for hose 0.780" to 0.860" OD.	1,000	—	12.0	6	1	0.038	47.80
HC16-4.0-1000	16mm X 4" long for hose 0.880" to 0.960" OD.	1,000	—	12.0	6	1	0.038	62.20
H-Curls (Gaylord Quantities)								
HC13-3.0	13mm X 3" long for hose 0.640" to 0.720" OD.	—	40,000	280.0	127	37	1.059	46.50
HC13-4.0	13mm X 4" long for hose 0.680" to 0.760" OD.	—	30,000	280.0	127	37	1.059	62.00
HC16-3.0	16mm X 3" long for hose 0.780" to 0.860" OD.	—	32,000	325.0	148	37	1.059	45.60
HC16-4.0	16mm X 4" long for hose 0.880" to 0.960" OD.	—	24,000	220.0	100	37	1.059	59.90

Shaded area indicates products being discontinued. Limited to available stocks on hand.



Hose & Dripline Fittings

Hose Fittings Accessories (Category VIII)

Part Number	Description	Quantity		Carton Weight		Carton Cube		List Price Each
		Bag	Carton	Lbs.	Kilos	Ft.	M.	
Rubber Grommet Adapters, for PVC.								
 FGR15	Rubber Grommet with 1/2" FPT , drill size 1.0" 25.5mm, min PVC size: 1-1/2" 40mm (for use with FAM fittings)	—	1,500	25.0	11.3	1.35	0.038	1.16
FGR20	Rubber Grommet with 3/4" FPT , drill size 1.2" 30mm, min PVC size: 1-1/2" 40mm (for use with FAM fittings)	—	1,000	25.0	11.3	1.35	0.038	1.44
FGR25	Rubber Grommet with 1" FPT , drill size 1.5" 38mm, min PVC size: 2" 50mm	—	700	25.0	11.3	1.35	0.038	1.74
Threaded Cap & Washers								
FEP1380	3/4" FHT Cap w/ Washer	100	1,200	12.0	5.4	1.35	0.038	0.44
FEP1376	3/4" Washer w/ Screen	—	5,000	25.0	11.3	1.50	0.042	0.38
FEP1377	3/4" Washer	—	7,000	22.0	10.0	1.00	0.028	0.08
Wire Ties & Handles								
 FMH08-1	Wire tie handle	—	1	—	—	—	—	14.40
FWA01	Stainless steel wire tie, 18 gauge, 6" long	—	5,000	22.0	10.0	0.91	0.026	0.12
FWA02	Galvanized steel wire tie, 18 gauge, 6" long	—	5,000	24.0	10.9	0.63	0.018	0.05
FWA03	Stainless steel wire tie, 18 gauge, 7" long	—	5,000	—	—	—	—	0.10
FWA04	Stainless steel wire tie, 18 gauge, 8" long	—	5,000	—	—	—	—	0.14
 FWA05	Galvanized steel wire tie, 16 gauge, 10" long	—	5,000	—	—	—	—	0.13
Locating Stakes								
 IPS0104	Black Stabilizer/Locator Stake for Micro-Tubing	100	3,000	32.0	14.5	1.35	0.038	0.40
IPS1500	Black Locator Stake for 10mm to 20mm Hose	100	500	12.0	5.4	1.35	0.038	0.41
SS6-50	6" Galv. Steel Soil Staple for 10mm to 20mm Hose	50	1,000	38.0	17.2	0.44	0.013	0.14

Check & Flush Valves (Category VI)

Part Number	Description	Quantity		Carton Weight		Carton Cube		List Price Each
		Bag	Carton	Lbs.	Kilos	Ft.	M.	
 JVO500-S2	Inline Valve for 5/8" OD Tubing	25	500	—	—	—	—	13.60
Flush Valve								
FCH-H-FIPT	3/4"FPT, .8 gpm, 2 psi Sealing Pressure, Flush Valve	1	—	—	—	—	—	2.99
FCH-H-FHT	3/4"FHT, .8 gpm, 2 psi Sealing Pressure, Flush Valve	50	1,200	25	11.3	1.81	0.051	2.99

Ordering Information:

◇ = MADE TO ORDER. Minimum order quantity will apply. Please consult Toro Micro-Irrigation Customer Service for availability.

Shaded area indicates products being discontinued. Limited to available stocks on hand.



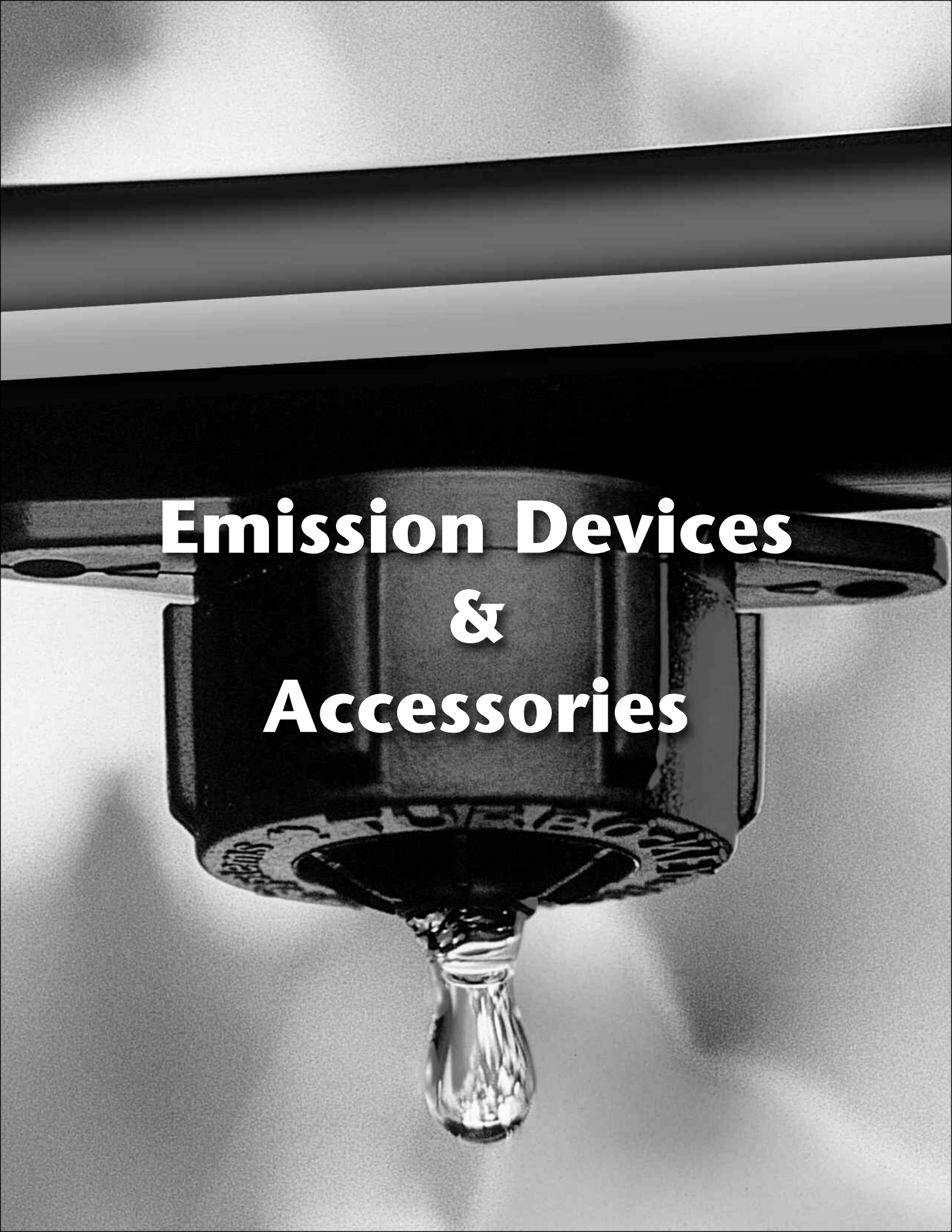

**Emission Devices
&
Accessories**

Emission Devices

N.G.E® New Generation Emitter (Category IV)

Flow rate expressed gph @ 30 psi (2 Bar)

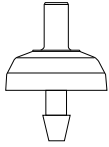

Part Number	Description	Quantity		Carton Weight		Carton Cube		List Price Each
		Bag	Carton	Lbs.	Kilos	Ft.	M.	
N.G.E® AL (Anti-Drain) Pressure Compensating Turbulent Flow Emitter with Male Adapter								
DPC02-MA-AL-BLUE	0.53 gph (2 lph) N.G.E® AL w/ Male Adapter (Blue Cap)	100	5,000	27.00	12.25	1.35	0.038	0.26
DPC03-MA-AL-GREEN	0.80 gph (3 lph) N.G.E® AL w/ Male Adapter (Green Cap)	100	5,000	27.00	12.25	1.35	0.038	0.26
DPC04-MA-AL-GREY	1.06 gph (4 lph) N.G.E® AL w/ Male Adapter (Grey Cap)	100	5,000	27.00	12.25	1.35	0.038	0.26
DPC08-MA-AL-RED	2.11 gph (8 lph) N.G.E® AL w/ Male Adapter (Red Cap)	100	5,000	27.00	12.25	1.35	0.038	0.26

-MA (Male Adapter) suitable for use with Black Spider (Part No. DBSxxx-xx)

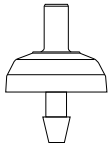

Part Number	Description	Quantity		Carton Weight		Carton Cube		List Price Each
		Bag	Carton	Lbs.	Kilos	Ft.	M.	
N.G.E® SF (Self Flushing) Pressure Compensating Turbulent Flow Emitter with Male Adapter								
DPC02-MA-BLUE	0.53 gph (2 lph) N.G.E® SF w/ Male Adapter (Blue Base)	100	5,000	27.00	12.25	1.35	0.038	0.26
DPC03-MA-GREEN	0.80 gph (3 lph) N.G.E® SF w/ Male Adapter (Green Base)	100	5,000	27.00	12.25	1.35	0.038	0.26
DPC04-MA-BLACK	1.06 gph (4 lph) N.G.E® SF w/ Male Adapter (Black Base)	100	5,000	27.00	12.25	1.35	0.038	0.26
DPC08-MA-RED	2.11 gph (8 lph) N.G.E® SF w/ Male Adapter (Red Base)	100	5,000	27.00	12.25	1.35	0.038	0.26

-MA (Male Adapter) suitable for use with Black Spider (Part No. DBSxxx-xx)

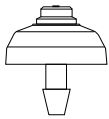

Part Number	Description	Quantity		Carton Weight		Carton Cube		List Price Each
		Bag	Carton	Lbs.	Kilos	Ft.	M.	
N.G.E® SF (Self Flushing) Pressure Compensating Turbulent Flow Emitter with Dust Cap								
DPC02-DC	0.53 gph (2 lph) N.G.E® SF w/ Dust Cap (Black Cap)	100	5,000	27.00	12.25	1.35	0.038	0.33
DPC02-DC-BLUE	0.53 gph (2 lph) N.G.E® SF w/ Dust Cap (Blue Cap)	100	5,000	27.00	12.25	1.35	0.038	0.33
DPC03-DC	0.80 gph (3 lph) N.G.E® SF w/ Dust Cap (Black Cap)	100	5,000	27.00	12.25	1.35	0.038	0.33
DPC04-DC	1.06 gph (4 lph) N.G.E® SF w/ Dust Cap (Black Cap)	100	5,000	27.00	12.25	1.35	0.038	0.33
DPC08-DC	2.11 gph (8 lph) N.G.E® SF w/ Dust Cap (Black Cap)	100	5,000	27.00	12.25	1.35	0.038	0.33
DPC08-DC-RED	2.11 gph (8 lph) N.G.E® SF w/ Dust Cap (Red Cap)	100	5,000	27.00	12.25	1.35	0.038	0.33

Turbo-SC® Plus Emitter (Category IV)

with Male Adapter Outlet

Flow rate expressed gph @ 30 psi (2 Bar)

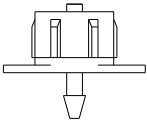

Part Number	Description	Quantity		Carton Weight		Carton Cube		List Price Each
		Bag	Carton	Lbs.	Kilos	Ft.	M.	
Turbo-SC® Plus Pressure Compensating Turbulent Flow Emitter with Male Adapter								
DPJ02-A-BLUE	0.53 gph (2 lph) Turbo-SC® Plus (Black Blue Base)	100	2,600	27.00	12.25	1.35	0.038	0.39
DPJ04-A	1.06 gph (4 lph) Turbo-SC® Plus (Black Base)	100	2,600	27.00	12.25	1.35	0.038	0.39
DPJ08-A-RED	2.11 gph (8 lph) Turbo-SC® Plus (Black Red Base)*	100	2,600	27.00	12.25	1.35	0.038	0.39

Turbo-Plus™ II Emitter (Category IV)

with Self Piercing Barb Inlet & Male Adapter Outlet

Flow rate expressed gph @ 30 psi (2 Bar)

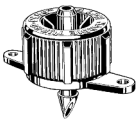

Part Number	Description	Quantity		Carton Weight		Carton Cube		List Price Each
		Bag	Carton	Lbs.	Kilos	Ft.	M.	
Turbo-Plus II Pressure Compensating Turbulent Flow Emitter with Self Piercing Barb Inlet & Male Adapter Outlet								
DPJ02-3	0.53 gph (2 lph) Turbo-Plus™ II (Black Base) (#1014052)	200	2,000	27.00	12.25	1.35	0.038	0.39
DPJ04-3	1.06 gph (4 lph) Turbo-Plus™ II (Black Base) (#1014054)	200	2,000	27.00	12.25	1.35	0.038	0.39
DPJ08-3	2.11 gph (8 lph) Turbo-Plus™ II (Black Base) (#1014058)	200	2,000	27.00	12.25	1.35	0.038	0.39

Emission Devices

Turbo-Key® II Emitter (Category IV)

with Self Piercing Barb Inlet

Flow rate expressed gph @ 15 psi (1 Bar)



Part Number	Description	Quantity		Carton Weight		Carton Cube		List Price Each
		Bag	Carton	Lbs.	Kilos	Ft.	M.	
Turbo-Key® II Turbulent Flow Emitter with Self Piercing Barb Inlet								
DNK02-3	0.53 gph (2 lph) Turbo-Key® (Black Base/White Pill) (#1014002)	200	2,000	28.00	15.42	2.20	0.038	0.43
DNK04-3	1.06 gph (4 lph) Turbo-Key® (Black Base/Blue-Black Pill) (#1014004)	200	2,000	28.00	15.42	2.20	0.038	0.43
DNK08-3	2.11 gph (8 lph) Turbo-Key® (Black Base/Green Pill) (#1014008)	200	2,000	28.00	15.42	2.20	0.038	0.43

E-2® Emitter (Category IV)

Flow rate expressed gph @ 15 psi (1 Bar)

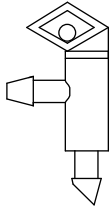

Part Number	Description	Quantity		Carton Weight		Carton Cube		List Price Each
		Bag	Carton	Lbs.	Kilos	Ft.	M.	
E-2® Laminar Flow Emitter with Self Piercing Barb Inlet & Barb Outlet (Bags of 100)								
DBK04-100	1.06 gph (4 lph) E-2® (Black Insert)	100	5,000	33.00	14.97	1.35	0.038	0.22
DBK08-100	2.11 gph (8 lph) E-2® (Black Insert)	100	5,000	33.00	14.97	1.35	0.038	0.22
DBK16-100	4.23 gph (16 lph) E-2® (Black Insert)	100	5,000	33.00	14.97	1.35	0.038	0.22
E-2® Laminar Flow Emitter with Self Piercing Barb Inlet & Barb Outlet (Bags of 1,000)								
DBK04	1.06 gph (4 lph) E-2® (Black Insert)	1,000	10,000	33.00	14.97	1.35	0.038	0.20
DBK08	2.11 gph (8 lph) E-2® (Black Insert)	1,000	10,000	33.00	14.97	1.35	0.038	0.20
DBK16	4.23 gph (16 lph) E-2® (Black Insert)	1,000	10,000	33.00	14.97	1.35	0.038	0.20

· Barb Outlet is suitable for use with Micro-Distribution Hose (Part No. EVR0433-xxx)

Pot Spray Stakes (Category IV)

for Greenhouse & Nursery Applications

Flow rate expressed gph @ 20 psi (1,4 Bar)

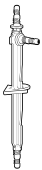

Part Number	Description	Quantity		Carton Weight		Carton Cube		List Price Each
		Bag	Carton	Lbs.	Kilos	Ft.	M.	
5" Length Nursery Pot Spray Stake								
IPS03BK	5.6 gph (21.2 lph) Black (0.03" Orifice)	100	1,000	12.00	5.40	1.15	0.033	0.26
IPS03BL	10.5 gph (39.7 lph) Blue (0.04" Orifice)	100	1,000	12.00	5.40	1.15	0.033	0.26
IPS03GR	16.0 gph (60.6 lph) Green (0.05" Orifice)	100	1,000	12.00	5.40	1.15	0.033	0.26

· Pot Spray Stakes use 1/8" PEVA Leader Tube



Emitter Accessories

Black Spider Single Barbed Elbow Stake Assembly (Category IV)

Single Outlet Device for use with NGE Emitters with Male Adaptor (Part No. DPCxx-MA)

Part Number	Description	Quantity		Carton Weight		Carton Cube		List Price Each
		Bag	Carton	Lbs.	Kilos	Ft.	M.	
Single Stake Assembly with 1 Outlet Barbed Elbow x Female Adaptor, Leader Tube & Barbed Elbowed Stake								
◇ DBS1-18	18" (45cm) Leader Tube	—	500	15.00	6.80	1.04	0.029	0.50
◇ DBS1-24	24" (60cm) Leader Tube	—	500	16.00	7.30	1.26	0.036	0.52
◇ DBS1-30	30" (76cm) Leader Tube	—	500	22.00	10.00	1.56	0.044	0.54
◇ DBS1-32	32" (81cm) Leader Tube	—	500	22.00	10.00	1.56	0.044	0.55 0
◇ DBS1-36	36" (91cm) Leader Tube	—	500	23.00	10.40	1.70	0.048	0.56
Single Stake Assembly with 1 Outlet Barbed Straight x Female Adaptor, Leader Tube & Barbed Elbowed Stake								
◇ DBS1S-18	18" (45cm) Leader Tube	—	500	14.00	6.40	1.04	0.029	0.50
◇ DBS1S-24	24" (60cm) Leader Tube	—	500	18.00	8.20	1.26	0.036	0.52
◇ DBS1S-30	30" (76cm) Leader Tube	—	500	21.00	9.50	1.56	0.044	0.54
◇ DBS1S-32	32" (81cm) Leader Tube	—	500	21.00	9.50	1.56	0.044	0.55
◇ DBS1S-36	36" (91cm) Leader Tube	—	500	22.00	10.00	1.70	0.048	0.56

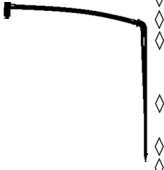

White Spider Single Barbed Elbow Stake Assembly (Category IV)

Single Outlet Device for use with NGE Emitters with Male Adaptor (Part No. DPCxx-MA)

Tubing made from PEVA material

Part Number	Description	Quantity		Carton Weight		Carton Cube		List Price Each
		Bag	Carton	Lbs.	Kilos	Ft.	M.	
White Spider Single Stake Assembly with 1 Outlet Barbed Elbow x Female Adaptor, Leader Tube & Barbed elbowed Stake								
◇ DWS1-18	18" (45cm) Leader Tube	—	800	15.00	6.80	1.04	0.029	0.54
◇ DWS1-24	24" (60cm) Leader Tube	—	800	16.00	7.30	1.26	0.036	0.56
◇ DWS1-30	30" (76cm) Leader Tube	—	800	22.00	10.00	1.56	0.044	0.58
◇ DWS1-32	32" (81cm) Leader Tube	—	800	22.00	10.00	1.56	0.044	0.59
◇ DWS1-36	36" (91cm) Leader Tube	—	800	23.00	10.40	1.70	0.048	0.60
White Spider Single Stake Assembly with 1 Outlet Barbed Elbow x Female Adaptor, Leader Tube & Barbed elbowed Stake								
◇ DWS1S-18	18" (45cm) Leader Tube	—	800	14.0	6.4	1.04	0.029	0.54
◇ DWS1S-24	24" (60cm) Leader Tube	—	800	18.0	8.2	1.26	0.036	0.56
◇ DWS1S-30	30" (76cm) Leader Tube	—	800	21.0	9.5	1.56	0.044	0.58
◇ DWS1S-32	32" (81cm) Leader Tube	—	800	21.0	9.5	1.56	0.044	0.59
◇ DWS1S-36	36" (91cm) Leader Tube	—	800	22.0	10.0	1.70	0.048	0.60

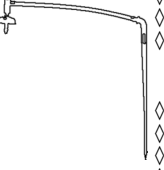

Black Spider Assembly (Category IV)

Multi-Outlet Device for use with NGE Emitters with Male Adaptor (Part No. DPCxx-MA)

Part Number	Description	Quantity		Carton Weight		Carton Cube		List Price Each
		Bag	Carton	Lbs.	Kilos	Ft.	M.	
Black Spider Assembly with 2 Outlet Barbed Tee x Female Adaptor, Leader Tube & 2 Turbulent Elbowed Stakes								
◇ DBS2Q-18	18" (45cm) Leader Tube	—	360	14.00	6.40	1.04	0.029	0.72
◇ DBS2Q-24	24" (60cm) Leader Tube	—	360	17.00	7.70	1.26	0.036	0.76
◇ DBS2Q-30	30" (76cm) Leader Tube	—	360	21.00	9.50	1.56	0.044	0.80
◇ DBS2Q-32	32" (81cm) Leader Tube	—	360	21.00	9.50	1.56	0.044	0.82
◇ DBS2Q-36	36" (91cm) Leader Tube	—	360	22.00	10.00	1.70	0.048	0.84
Black Spider Assembly with 2 Outlet Barbed Tee x Female Adaptor, Leader Tube & 2 Turbulent Straight Stakes								
◇ DBS2S-18	18" (45cm) Leader Tube	—	400	15.00	6.80	1.04	0.029	0.72
◇ DBS2S-24	24" (60cm) Leader Tube	—	400	18.00	8.20	1.26	0.036	0.76
◇ DBS2S-30	30" (76cm) Leader Tube	—	400	22.00	10.00	1.56	0.044	0.80
◇ DBS2S-32	32" (81cm) Leader Tube	—	400	22.00	10.00	1.56	0.044	0.82
◇ DBS2S-36	36" (91cm) Leader Tube	—	400	23.00	10.40	1.70	0.048	0.84
Black Spider Assembly with 4 Outlet Barbed Manifold x Female Adaptor, Leader Tube & 4 Turbulent Elbowed Stakes								
◇ DBS4Q-18	18" (45cm) Leader Tube	—	180	9.00	4.10	1.04	0.029	1.30
◇ DBS4Q-24	24" (60cm) Leader Tube	—	180	18.00	8.20	1.26	0.036	1.38
◇ DBS4Q-30	30" (76cm) Leader Tube	—	180	20.00	9.10	1.56	0.044	1.46
◇ DBS4Q-32	32" (81cm) Leader Tube	—	180	20.00	9.10	1.56	0.044	1.50
◇ DBS4Q-36	36" (91cm) Leader Tube	—	180	21.00	9.50	1.70	0.048	1.54
Black Spider Assembly with 4 Outlet Barbed Manifold x Female Adaptor, Leader Tube & 4 Turbulent Straight Stakes								
◇ DBS4S-18	18" (45cm) Leader Tube	—	200	14.00	6.40	1.04	0.029	1.30
◇ DBS4S-24	24" (60cm) Leader Tube	—	200	19.00	8.60	1.26	0.036	1.38
◇ DBS4S-30	30" (76cm) Leader Tube	—	200	13.00	5.90	1.56	0.044	1.46
◇ DBS4S-32	32" (81cm) Leader Tube	—	200	13.00	5.90	1.56	0.044	1.50
◇ DBS4S-36	36" (91cm) Leader Tube	—	200	23.00	10.40	1.70	0.048	1.54

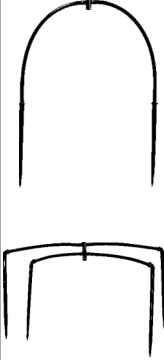

Ordering Information:

◇ = MADE TO ORDER. 1,000 minimum order quantity will apply. Please consult Toro Micro-Irrigation Customer Service for availability.

Emitter Accessories

White Spider Assembly (Category IV)

Multi-Outlet Device for use with NGE Emitters with Male Adaptor (Part No. DPCxx-MA)
 Tubing made from PEVA material

Part Number	Description	Quantity		Carton Weight		Carton Cube		List Price Each
		Bag	Carton	Lbs.	Kilos	Ft.	M.	
White Spider Assembly with 2 Outlet Barbed Tee x Female Adaptor, Leader Tube & 2 Turbulent Elbowed Stakes								
◇ DWS2Q-18	18" (45cm) Leader Tube	—	360	17.00	7.70	1.26	0.036	0.86
◇ DWS2Q-24	24" (60cm) Leader Tube	—	360	21.00	9.50	1.56	0.044	0.90
◇ DWS2Q-30	30" (76cm) Leader Tube	—	360	21.00	9.50	1.56	0.044	0.92
◇ DWS2Q-32	32" (81cm) Leader Tube	—	360	22.00	10.00	1.70	0.048	0.94
Call Toro Micro-Irrigation Customer Service								
White Spider Assembly with 2 Outlet Barbed Tee x Female Adaptor, Leader Tube & 2 Turbulent straight Stakes								
◇ DWS2S-18	18" (45cm) Leader Tube	—	400	15.00	6.80	1.04	0.029	0.82
◇ DWS2S-24	24" (60cm) Leader Tube	—	400	18.00	8.20	1.26	0.036	0.86
◇ DWS2S-30	30" (76cm) Leader Tube	—	400	22.00	10.00	1.56	0.044	0.90
◇ DWS2S-32	32" (81cm) Leader Tube	—	400	22.00	10.00	1.56	0.044	0.92
◇ DWS2S-36	36" (91cm) Leader Tube	—	400	23.00	10.40	1.70	0.048	0.94
White Spider Assembly with 4 Outlet Barbed Manifold x Female Adaptor, Leader Tube & 4 Turbulent Elbowed Stakes								
◇ DWS4Q-18	18" (45cm) Leader Tube	—	180	9.00	4.10	1.04	0.029	1.50
◇ DWS4Q-24	24" (60cm) Leader Tube	—	180	18.00	8.20	1.26	0.036	1.58
◇ DWS4Q-30	30" (76cm) Leader Tube	—	180	20.00	9.10	1.56	0.044	1.66
◇ DWS4Q-32	32" (81cm) Leader Tube	—	180	20.00	9.10	1.56	0.044	1.70
◇ DWS4Q-36	36" (91cm) Leader Tube	—	180	21.00	9.50	1.70	0.048	1.74
White Spider Assembly with 4 Outlet Barbed Manifold x Female Adaptor, Leader Tube & 4 Turbulent Straight Stakes								
◇ DWS4S-18	18" (45cm) Leader Tube	—	200	14.00	6.40	1.04	0.029	1.50
◇ DWS4S-24	24" (60cm) Leader Tube	—	200	19.00	8.60	1.26	0.036	1.58
◇ DWS4S-30	30" (76cm) Leader Tube	—	200	13.00	5.90	1.56	0.044	1.66
◇ DWS4S-32	32" (81cm) Leader Tube	—	200	13.00	5.90	1.56	0.044	1.70
◇ DWS4S-36	36" (91cm) Leader Tube	—	200	23.00	10.40	1.70	0.048	1.74

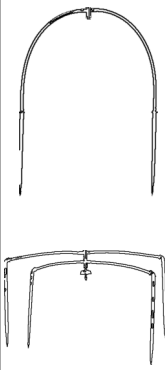

Black Spider & Single Stake Fittings (Category VIII)

Part Number	Description	Quantity		Carton Weight		Carton Cube		List Price Each
		Bag	Carton	Lbs.	Kilos	Ft.	M.	
Single Stake Fittings & Stakes								
FBS1E	Black Spider - 1 Outlet Barbed Elbow x Female Adapter	1,000	20,000	32.00	14.50	1.35	0.038	0.04
FBS1S	Black Spider - 1 Outlet Barbed Straight x Female Adapter	1,000	20,000	32.00	14.50	1.35	0.038	0.05
IPS0301BQ	Black Spider - Barbed Elbowed Stake	—	1,000	6.00	2.70	0.46	0.013	0.11
Black Spider Fittings & Stakes								
FBS2	Black Spider - 2 Outlet Barbed Tee x Female Adapter	1,000	20,000	36.00	16.30	1.35	0.038	0.06
FBS2-MA	Black Spider - 2 Outlet Barbed Manifold x Female / Male Adaptor	1,000	15,000	30.00	13.60	1.35	0.038	0.04
IPS0301	Black Spider - Turbulent Flow Straight Stake	—	1,400	8.00	3.60	0.46	0.013	0.11
IPS0301Q	Black Spider - Turbulent Flow Elbowed Stake	—	600	5.00	2.30	0.46	0.013	0.11

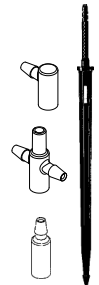

Black Spider & Pot Spray Stake Leader Tube (Category III)

Part Number	Description	Quantity		Carton Weight		Carton Cube		List Price Each
		Bundle	Carton	Lbs.	Kilos	Ft.	M.	
1/8" PEVA Leader Tube (0.126" ID x 0.196" OD x 0.035" Wall)								
◇ SFH0332-18	18" (45cm) Length	100	1,000	13.00	5.50	—	—	0.13
◇ SFH0332-24	24" (60cm) Length	100	1,000	18.00	8.00	1.20	0.034	0.17
◇ SFH0332-30	30" (76cm) Length	100	1,000	23.00	10.00	1.40	0.04	0.21
◇ SFH0332-32	32" (81cm) Length	100	1,000	23.00	10.00	1.40	0.04	0.22
◇ SFH0332-36	36" (91cm) Length	100	1,000	26.00	12.00	—	—	0.25



Ordering Information:

◇ = MADE TO ORDER. 1,000 minimum order quantity will apply. Please consult Toro Micro-Irrigation Customer Service for availability.

Shaded area indicates products being discontinued. Limited to available stocks on hand.



Emitter Accessories

Black Spider & Pot Spray Stake Micro-Distribution Hose (Category III)

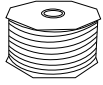

Part Number	Material	Size		Nominal Hose Size			Coil Length		Coil Ship Weight		Coils Per		List Price per Coil
		inch	mm	ID inch	OD inch	Wall inch	Ft.	M.	Lbs.	Kilos	Box	Pallet	
1/8" PEVA Micro-Distribution Hose, Black													
EVRO332-100	PEVA	1/8"	3	0.126"	0.196"	0.035"	1,000	305	7.20	3.30	2	100	54.00
EVRO332-250	PEVA	1/8"	3	0.126"	0.196"	0.035"	2,500	762	18.50	8.40	1	50	131.00
1/8" PEVA Micro-Distribution Hose, White													
WHD0335-100	PEVA	1/8"	3	0.126"	0.196"	0.035"	1,000	305	7.20	3.30	2	100	92.00

Ordering Information:

◇ = MADE TO ORDER. 100,000 Ft. minimum order quantity will apply. Please consult Toro Micro-Irrigation Customer Service for availability.

Punches & Tools (Category VIII)

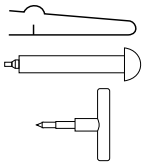

Part Number	Description	Quantity		Carton Weight		Carton Cube		List Price Each
		Bag	Carton	Lbs.	Kilos	Ft.	M.	
IT-DNK00	DNK/DPJ Turbo-Key/Plus Disassembly Wrench	10	—	—	—	—	—	1.72
FMP16	Hose punch to insert 4mm barb fitting, stainless steel	1	250	38.0	17.2	1.63	0.046	15.40
FMP08	Hose punch to insert 4mm barb fitting, plastic/steel	1	2,100	—	—	—	—	2.70
FHP16	Oval hose punch, steel	1	—	—	—	—	—	84.10



Aqua-Traxx®
with the PBX Advantage



NGE®



Aqua-Clear
Fiberglass Sand Filters



BlueLine™



Pro-Loc™ Fittings

The Blue Stripe of Quality.

TORO® Count on it.

©2011 Toro Micro-Irrigation, 1588 N. Marshall Avenue, El Cajon, CA 92020 (800) 333-8125



Foggers & Jets

Foggers (Category IV)

Flow rate expressed in gph @ 20 psi (1,4 Bar)

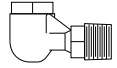
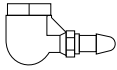

Part Number	Description	Quantity		Carton Weight		Carton Cube		List Price Each
		Bag	Carton	Lbs.	Kilos	Ft.	M.	
Foggers with 1/4" Barb								
SFJ408	1.9 gph (7,6 lph) Barbed Fogger	100	5,000	27.00	12.25	1.35	0.038	0.74
SFJ412	3.0 gph (11,7 lph) Barbed Fogger	100	5,000	27.00	12.25	1.35	0.038	0.74
SFJ416	3.9 gph (15,4 lph) Barbed Fogger	100	5,000	27.00	12.25	1.35	0.038	0.74
Foggers with 1/8" MPT Thread								
SFL408	1.9 gph (7,6 lph) Threaded Fogger	100	5,000	27.00	12.25	1.35	0.038	0.81
SFL412	3.0 gph (11,7 lph) Threaded Fogger	100	5,000	27.00	12.25	1.35	0.038	0.81
SFL416	3.9 gph (15,4 lph) Threaded Fogger	100	5,000	27.00	12.25	1.35	0.038	0.81
Foggers Threaded with 1/4" Barb Stake								
SFL4081	1.9 gph (7,6 lph) Threaded Fogger w/stake	100	1,000	30.00	13.61	1.35	0.038	1.60
SFL4121	3.0 gph (11,7 lph) Threaded Fogger w/stake	100	1,000	30.00	13.61	1.35	0.038	1.60
SFL4161	3.9 gph (15,4 lph) Threaded Fogger w/stake	100	1,000	30.00	13.61	1.35	0.038	1.60

Snap-Jet® II (Category V)

Flow rate expressed in gph @ 20 psi (1,4 Bar)

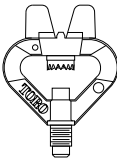

Part Number	Description	Quantity		Carton Weight		Carton Cube		List Price Each
		Bag	Carton	Lbs.	Kilos	Ft.	M.	
Snap-Jet® Heads								
SSJ30x	6.0 gph (22.7 lph) Black Snap-Jet	100	5,000	21.00	9.53	1.35	0.038	0.38
SSJ35x	8.4 gph (31.8 lph) Orange Snap-Jet	100	5,000	21.00	9.53	1.35	0.038	0.38
SSJ40x	10.7 gph (40.5 lph) Blue Snap-Jet	100	5,000	21.00	9.53	1.35	0.038	0.38
SSJ45x	14.1 gph (53.4 lph) Purple Snap-Jet	100	5,000	21.00	9.53	1.35	0.038	0.38
SSJ50x	16.7 gph (63.2 lph) Green Snap-Jet	100	5,000	21.00	9.53	1.35	0.038	0.38
SSJ55x	20.5 gph (77.6 lph) Yellow Snap-Jet	100	5,000	21.00	9.53	1.35	0.038	0.38
SSJ60x	24.0 gph (90.8 lph) Red Snap-Jet	100	5,000	21.00	9.53	1.35	0.038	0.38
Snap-Jet® Deflector Plate								
SPP4000-x	Replacement Deflector Plate	3,000	21,000	34.00	15.42	1.35	0.038	0.13

Deflector Plate Spray Configurations

* Replace "x" in the Snap-Jet part numbers above with the letter of the pattern desired:								
	A	B	C	D	E	F	H	J
	Small Circle 360° x 16 streams	Large Circle 360° x 16 streams	Hi-Lo Circle 360° x 16 streams	Hi-Lo Notch 330° x 11 streams	Half Circle 180° x 9 streams	Deflector Solid 360°	Hi-Lo butterfly 2 x 120°, 10 streams	Solid Butterfly 2 x 140°, Solid

Snap-Jet® II Assemblies (Category V)

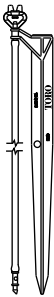

Part Number	Description	Quantity		Gaylord Weight		Gaylord Cube		List Price Each
		Bundle	Gaylord	Lbs.	Kilos	Ft.	M.	
Snap-Jet® II Hose Assembly (To order Hose Assembly; replace xxx with the last 3 digits of the Snap-Jet® part number.)								
SJAxxx-24C	Snap-Jet® Hose Assembly w/ 24" Leader Tube	10	—	—	—	53.90	1.525	1.33
SJAxxx-30C	Snap-Jet® Hose Assembly w/ 30" Leader Tube	10	3,000	550.00	249.50	53.90	1.525	1.39
SJAxxx-36C	Snap-Jet® Hose Assembly w/ 36" Leader Tube	10	—	—	—	53.90	1.525	1.45
· Assembly includes SSJxxx snap-jet, 24", 30" or 36" Leader Tube and 4mm Coupling.								
Snap-Jet® II Clip Stake Assembly (To order Clip Stake Assembly; replace xxx with the last 3 digits of the Snap-Jet® part number.)								
SJAxxx00-24C	Snap-Jet® Clip Stake Assembly w/ 24" Leader Tube	10	—	—	—	53.90	1.525	1.77
SJAxxx00-30C	Snap-Jet® Clip Stake Assembly w/ 30" Leader Tube	10	—	—	—	53.90	1.525	1.74
SJAxxx00-36C	Snap-Jet® Clip Stake Assembly w/ 36" Leader Tube	10	—	—	—	53.90	1.525	1.77
· Assembly includes SSJxxx Snap-Jet; IPS0400 Clip Stake; 24", 30" or 36" Leader Tube and 4mm Coupling.								
· Standard stake color is Black. (Red is available for an additional cost.)								
Snap-Jet® II Barb Stake Assembly (To order Barb Stake Assembly; replace xxx with the last 3 digits of the Snap-Jet® part number.)								
SJAxxx03-24D	Snap-Jet® Barb Stake Assembly w/ 24" Leader Tube	10	—	—	—	53.90	1.525	1.75
SJAxxx03-30D	Snap-Jet® Barb Stake Assembly w/ 30" Leader Tube	10	—	—	—	53.90	1.525	1.78
SJAxxx03-36D	Snap-Jet® Barb Stake Assembly w/ 36" Leader Tube	10	—	—	—	53.90	1.525	1.81
· Assembly includes SSJxxx Snap-Jet; IPS0403 Barb Stake; 24", 30" or 36" Leader Tube and 4mm Coupling.								
· Standard stake color is Black. (Red is available for an additional cost.)								

Part Number: **SJA 40 A 03 - 36 D**

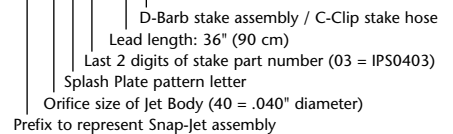

Ordering Information:

◇ = MADE TO ORDER. 1,000 minimum order quantity will apply. Please consult Toro Micro-Irrigation Customer Service for availability.



To order, call Toro Micro-Irrigation
 El Cajon, Ca: +1 (800) 333-8125 or +1 (619) 562-2950
 Sanford, Fl: +1 (800) 806-6582 or +1 (407) 321-2901
 List Prices are US\$. FOB Shipping Point. Effective November 19, 2014 (ALT002)

Micro-Sprinklers

Micro-Sprinkler VI Classic (Category V)

Flow rate expressed in gph @ 20 psi (1,4 Bar)

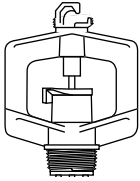

Part Number	Description	Quantity		Carton Weight		Carton Cube		List Price Each
		Bag	Carton	Lbs.	Kilos	Ft.	M.	
Micro-Sprinkler VI Classic 3/8" MPT Inlet								
SAM610	9.1 gph (34,4 lph) w/ Black Nozzle, 3/8" MPT Inlet	50	1,500	25.0	11.34	1.35	0.038	0.89
SAM613	13.7 gph (51,0 lph) w/ White Nozzle, 3/8" MPT Inlet	50	1,500	25.0	11.34	1.35	0.038	0.89
SAM614	19.0 gph (71,9 lph) w/ Maroon Nozzle, 3/8" MPT Inlet	50	1,500	25.0	11.34	1.35	0.038	0.89
SAM616	24.8 gph (93,0 lph) w/ Green Nozzle, 3/8" MPT Inlet	50	1,500	25.0	11.34	1.35	0.038	0.89
SAM620	33.7 gph (127,6 lph) w/ Blue Nozzle, 3/8" MPT Inlet	50	1,500	25.0	11.34	1.35	0.038	0.89
SAM622	39.0 gph (147,6 lph) w/ Gray Nozzle, 3/8" MPT Inlet	50	1,500	25.0	11.34	1.35	0.038	0.89
SAM624	48.0 gph (182,1 lph) w/ Yellow Nozzle, 3/8" MPT Inlet	50	1,500	25.0	11.34	1.35	0.038	0.89
SAM628	65.1 gph (246,4 lph) w/ Red Nozzle, 3/8" MPT Inlet	50	1,500	25.0	11.34	1.35	0.038	0.89
◇ 101WB6-LTD-KIT	Low Trajectory Spinner & Bearing Kit	—	500	—	—	—	—	0.33

For Micro-Sprinkler VI Classic with break-off deflector tab spinner add -D to the part number. Example: SAM616-D.
 Note: SAM622, 624 & 628 not available with break-off deflector tab spinner

Micro-Sprinkler VI Classic Stake Assemblies (Category V)

(To order stake assembly: replace xxx with the last 3 digits of the Micro-Sprinkler® VI part number. Example: SAM613 would be SAM61330)



Part Number	Description	Quantity		Gaylord Weight		Gaylord Cube		List Price Each
		Bundle	Gaylord	Lbs.	Kilos	Ft.	M.	
Micro-Sprinkler VI Classic Stake Assembly								
◇ SAMxxx24	Micro-Sprinkler VI Stake Assembly w/ 24" Leader Tube	10	—	—	—	53.90	1.525	2.20
◇ SAMxxx30	Micro-Sprinkler VI Stake Assembly w/ 30" Leader Tube	10	1,000	500.00	226.80	53.90	1.525	2.22
◇ SAMxxx36	Micro-Sprinkler VI Stake Assembly w/ 36" Leader Tube	10	1,000	450.00	204.10	53.90	1.525	2.24
◇ SAMxxx48	Micro-Sprinkler VI Stake Assembly w/ 48" Leader Tube	10	—	—	—	53.90	1.525	2.28

Assemblies using SAM610 thru SAM616 will include Micro-Sprinkler; IPS1004 Stake; 24", 30", 36" or 48" Leader Tube and 4mm Coupling.
 Assemblies using SAM620 thru SAM628 will include Micro-Sprinkler; IPS1006 Stake; 24", 30", 36" or 48" Leader Tube and 6mm Coupling.
 For Micro-Sprinkler VI Classic with break-off deflector tab spinner add -D to the part number. Example: SAM616-D30.
 Note: SAM622, 624 & 628 not available with break-off deflector tab spinner

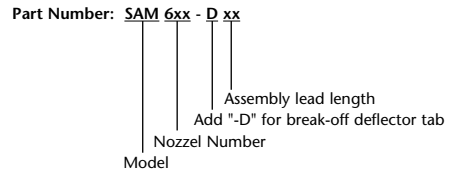

Micro-Sprinkler VI PC (Pressure Compensating) (Category V)

Flow rate expressed in gph @ 40 psi (2,75 Bar)

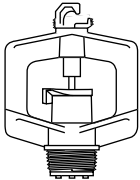

Part Number	Description	Quantity		Carton Weight		Carton Cube		List Price Each
		Bag	Carton	Lbs.	Kilos	Ft.	M.	
Micro-Sprinkler VI PC 3/8" MPT Inlet								
SSA630	9.20 gph (34,9 lph) w/ Brown Nozzle, 3/8" MPT Inlet	50	1,500	25.00	11.34	1.35	0.038	1.30
SSA632	12.4 gph (47,1 lph) w/ Light Blue Nozzle, 3/8" MPT Inlet	50	1,500	25.00	11.34	1.35	0.038	1.30
SSA634	14.6 gph (55,2 lph) w/ Light Green Nozzle, 3/8" MPT Inlet	50	1,500	25.00	11.34	1.35	0.038	1.30
SSA636	18.2 gph (69,0 lph) w/ Orange Nozzle, 3/8" MPT Inlet	50	1,500	25.00	11.34	1.35	0.038	1.30
SSA638	23.8 gph (88,0 lph) w/ Gray Nozzle, 3/8" MPT Inlet	50	1,500	25.00	11.34	1.35	0.038	1.30

For Micro-Sprinkler VI PC with break-off deflector tab spinner add -D to the part number. Example: SSA630-D.

Micro-Sprinkler VI PC - Stake Assemblies (Category V)

(To order stake assembly: replace xxx with the last 3 digits of the Micro-Sprinkler® VI part number. i.e. SSA630 would be SSA63024.)



Part Number	Description	Quantity		Gaylord Weight		Gaylord Cube		List Price Each
		Bundle	Gaylord	Lbs.	Kilos	Ft.	M.	
Micro-Sprinkler VI PC Stake Assembly								
◇ SSAxxx24	Micro-Sprinkler VI PC Stake Assembly w/ 24" Leader Tube	10	—	—	—	53.9	1.525	2.35
◇ SSAxxx30	Micro-Sprinkler VI PC Stake Assembly w/ 30" Leader Tube	10	1,000	500.00	226.80	53.9	1.525	2.41
◇ SSAxxx36	Micro-Sprinkler VI PC Stake Assembly w/ 36" Leader Tube	10	1,000	450.00	204.10	53.9	1.525	2.48
◇ SSAxxx48	Micro-Sprinkler VI PC Stake Assembly w/ 48" Leader Tube	10	—	—	—	53.9	1.525	2.55

Assemblies using SSA630 thru SAA638 will include Micro-Sprinkler; IPS1004 Stake; 24", 30", 36" or 48" Leader Tube and 4mm Coupling.
 For Micro-Sprinkler VI PC with break-off deflector tab spinner add -D to the part number. Example: SSA630-D30.

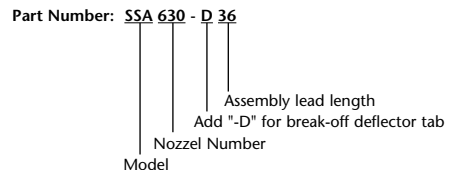

Ordering Information:

◇ = MADE TO ORDER. Minimum order quantity will apply. Please consult Toro Micro-Irrigation Customer Service for availability.

Shaded area indicates products being discontinued. Limited to available stocks on hand.



Micro-Sprinklers

Micro Sprinkler PC (Pressure Compensating) (Category V)

Flow rate expressed in gph @ 40 psi (2,75 Bar)

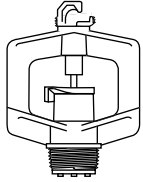

Part Number	Description	Quantity		Carton Weight		Carton Cube		List Price Each
		Bag	Carton	Lbs.	Kilos	Ft.	M.	
Micro-Sprinkler VI Classic 3/8" MPT Inlet								
MS7PC9	9.2 gph (35 lph) w/ Black Nozzle, 3/8" MPT Inlet	50	1,500	25.0	11.34	1.35	0.038	1.30
MS7PC12	12.2 gph (46 lph) w/ Light Blue Nozzle, 3/8" MPT Inlet	50	1,500	25.0	11.34	1.35	0.038	1.30
MS7PC15	14.8 gph (56 lph) w/ White Nozzle, 3/8" MPT Inlet	50	1,500	25.0	11.34	1.35	0.038	1.30
MS7PC20	19.3 gph (73 lph) w/ Maroon Nozzle, 3/8" MPT Inlet	50	1,500	25.0	11.34	1.35	0.038	1.30
MS7PC26	24.8 gph (94 lph) w/ Green Nozzle, 3/8" MPT Inlet	50	1,500	25.0	11.34	1.35	0.038	1.30
MS7PC31	29.3 gph (111 lph) w/ Purple Nozzle, 3/8" MPT Inlet	50	1,500	25.0	11.34	1.35	0.038	1.30
MS7PC35	33.8 gph (128 lph) w/ Blue Nozzle, 3/8" MPT Inlet	50	1,500	25.0	11.34	1.35	0.038	1.30
MS7PC40	38.0 gph (144 lph) w/ Gray Nozzle, 3/8" MPT Inlet	50	1,500	25.0	11.34	1.35	0.038	1.30

• For Micro Sprinkler PC with break-off deflector tab spinner add "D" to the part number. Example: MS7PC9D.

Micro Sprinkler PC - Stake Assemblies (Category V)

(To order stake assembly: replace xx with the last 1 or 2 digits of the Micro Sprinkler part number. For example, MS7PC9 with a 24" leader tube would be MS7PC924.)



Part Number	Description	Quantity		Gaylord Weight		Gaylord Cube		List Price Each
		Bundle	Gaylord	Lbs.	Kilos	Ft.	M.	
Micro Sprinkler PC Stake Assembly								
MS7PCxx24	Micro Sprinkler PC Stake Assembly w/ 24" Leader Tube	10	1,000	500	226.8	53.9	1.525	2.35
MS7PCxx30	Micro Sprinkler PC Stake Assembly w/ 30" Leader Tube	10	1,000	500	226.8	53.9	1.525	2.41
MS7PCxx36	Micro Sprinkler PC Stake Assembly w/ 36" Leader Tube	10	1,000	450	204.1	53.9	1.525	2.48
MS7PCxx48	Micro Sprinkler PC Stake Assembly w/ 48" Leader Tube	10	1,000	450	204.1	53.9	1.525	2.55

• Assemblies will use IPS1004 Stake; 24", 30", 36" or 48" Leader Tube and 4mm Coupling.

• For Micro Sprinkler PC with break off deflector tab spinner add "D" to the part number. Example MS7PC9D30.

Part Number: MS7PC 9 - D 24

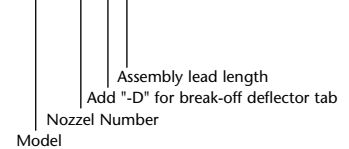

Ordering Information:

◇ = MADE TO ORDER. Minimum order quantity will apply. Please consult Toro Micro-Irrigation Customer Service for availability.





Fogger, Snap-Jet & Micro-Sprinkler Accessories

Adapters, Bases & Stakes (Category VIII)

Part Number	Description	Quantity		Carton Weight		Carton Cube		List Price Each
		Bag	Carton	Lbs.	Kilos	Ft.	M.	
Stakes for Foggers								
IPS0104	Stabilizer/Locator Stake for Barbed Fogger (Black)	100	3,000	32.00	14.50	1.35	0.038	0.40
IPS0409	1/8" FPT x 1/4" Barbed Fogger Stake (Black)	100	1,500	21.00	10.00	1.35	0.038	0.83
Stakes for Snap-Jet®								
IPS0400	Clip Stake - Black	—	200	16.30	7.00	1.35	0.038	0.80
◇ IPS0401	Clip Stake - Red	—	200	16.30	7.00	1.35	0.038	0.84
IPS0403	Barbed Stake 4mm x 10-32 UNF (self-tapping threads) - Black	—	200	12.00	5.00	1.35	0.038	0.76
Barb Stake Assemblies for Snap-Jet®								
◇ IPS040324	Barb Stake Assy. - Black w/ 24" Leader Tube & 4mm Take-off	10	3,000	450.00	204.10	53.90	1.525	1.12
IPS040330	Barb Stake Assy. - Black w/ 30" Leader Tube & 4mm Take-off	10	—	—	—	54.90	1.554	1.16
◇ IPS040336	Barb Stake Assy. - Black w/ 36" Leader Tube & 4mm Take-off	10	2,000	500.00	226.80	55.90	1.582	1.20
◇ IPS040348	Barb Stake Assy. - Black w/ 48" Leader Tube & 4mm Take-off	10	—	—	—	56.90	1.610	1.28
Accessories for Micro-Sprinkler								
WBD180R	Micro-Sprinkler 180 Deg. Red Deflector	50	—	—	—	—	—	0.44
Stakes for Micro-Sprinkler								
IPS1004	3/8"FPT x 4mm or 6mm Barbed Stake - Black	—	200	15.00	7.00	1.35	0.038	0.70
◇ IPS1004-1	3/8"FPT x 4mm or 6mm Barbed Stake - Red	—	200	15.00	7.00	1.35	0.038	0.70
IPS1006	3/8"FPT x 6mm Barbed Stake - Black	—	200	15.00	7.00	1.35	0.038	0.70
◇ IPS1006-1	3/8"FPT x 6mm Barbed Stake - Red	—	200	16.00	8.00	1.35	1.038	0.70
Stake Assemblies for Micro-Sprinkler								
◇ IPS100424	4mm Barbed Stake Assembly w/ 24" Leader Tube & 4mm Take-off	10	—	—	—	52.90	1.497	1.12
IPS100430	4mm Barbed Stake Assembly w/ 30" Leader Tube & 4mm Take-off	10	2,000	450.00	204.10	53.90	1.525	1.16
◇ IPS100436	4mm Barbed Stake Assembly w/ 36" Leader Tube & 4mm Take-off	10	2,000	500.00	226.80	54.90	1.554	1.20
◇ IPS100448	4mm Barbed Stake Assembly w/ 48" Leader Tube & 4mm Take-off	10	—	—	—	55.90	1.582	1.28
◇ IPS100624	6mm Barbed Stake Assembly w/ 24" Leader Tube & 6mm Take-off	10	—	—	—	55.90	1.582	1.15
IPS100630	6mm Barbed Stake Assembly w/ 30" Leader Tube & 6mm Take-off	10	—	—	—	55.90	1.582	1.21
◇ IPS100636	6mm Barbed Stake Assembly w/ 36" Leader Tube & 6mm Take-off	10	—	—	—	55.90	1.582	1.27
◇ IPS100648	6mm Barbed Stake Assembly w/ 48" Leader Tube & 6mm Take-off	10	—	—	—	55.90	1.582	1.33
Sta-Base for Micro-Sprinkler								
IPS1025	3/8"FPT Clamp & Sta-Base - Black (Unassembled)	—	100	12.00	5.00	1.35	0.038	0.96
SRP3299	Replacement 3/8"FPT Clamp for Sta-Base	100	400	—	—	1.35	0.038	0.40
SRP3300	Replacement Base for Sta-Base	—	100	—	—	1.35	0.038	0.57
Adapters								
IPG10091	3/8"FPT x 4mm Barb Adapter with 5mm Stake Insert	1,000	4,000	—	—	1.35	0.038	0.29

Ordering Information:

◇ = MADE TO ORDER. 1,000 minimum order quantity will apply. Please consult Toro Micro-Irrigation Customer Service for availability.

Shaded area indicates products being discontinued. Limited to available stocks on hand.



Fogger, Snap-Jet & Micro-Sprinkler Accessories

Leader Tube with Take-Off (Category VIII)



Part Number	Description	Quantity		Gaylord Weight		Gaylord Cube		List Price Each
		Bundle	Gaylord	Lbs.	Kilos	Ft.	M.	
Leader Tube with Take-Off								
◇ HWF424	4mm Leader Tube 24" w/ 4mm Barb Take-Off for 4mm Clip Stake	100	—	—	—	53.9	1.525	0.36
HWF430	4mm Leader Tube 30" w/ 4mm Barb Take-Off for 4mm Clip Stake	100	10,000	500.00	226.80	53.9	1.525	0.40
◇ HWF436	4mm Leader Tube 36" w/ 4mm Barb Take-Off for 4mm Clip Stake	100	—	—	—	53.9	1.525	0.45
◇ HWF324	4mm Leader Tube 24" w/ 4mm Barb Take-Off for 4mm Barb Stake	100	15,000	650.00	294.80	53.9	1.525	0.34
HWF330	4mm Leader Tube 30" w/ 4mm Barb Take-Off for 4mm Barb Stake	100	15,000	800.00	362.90	53.9	1.525	0.40
◇ HWF336	4mm Leader Tube 36" w/ 4mm Barb Take-Off for 4mm Barb Stake	100	15,000	950.00	430.90	53.9	1.525	0.45
◇ HWF348	4mm Leader Tube 48" w/ 4mm Barb Take-Off for 4mm Barb Stake	100	10,000	800.00	362.90	53.9	1.525	0.54
◇ HWF624	6mm Leader Tube 24" w/ 6mm Barb Take-Off for 6mm Barb Stake	100	—	—	—	53.9	1.525	0.38
HWF630	6mm Leader Tube 30" w/ 6mm Barb Take-Off for 6mm Barb Stake	100	—	—	—	53.9	1.525	0.45
◇ HWF636	6mm Leader Tube 36" w/ 6mm Barb Take-Off for 6mm Barb Stake	100	—	—	—	53.9	1.525	0.48
◇ HWF648	6mm Leader Tube 48" w/ 6mm Barb Take-Off for 6mm Barb Stake	100	—	—	—	53.9	1.525	0.57

Leader Tube (Category III)



Part Number	Description	Quantity		Gaylord Weight		Gaylord Cube		List Price Each
		Bundle	Gaylord	Lbs.	Kilos	Ft.	M.	
ULDPE Leader Tube (0.153" ID x 0.259" OD x 0.053" Wall)								
◇ SFH0424	4mm Leader Tube 24" for 4mm Clip Stake	100	—	—	—	52.90	1.497	0.21
SFH0430	4mm Leader Tube 30" for 4mm Clip Stake	100	—	—	—	53.90	1.525	0.26
◇ SFH0436	4mm Leader Tube 36" for 4mm Clip Stake	100	21,000	1,050.00	476.30	54.90	1.554	0.31
LLDPE Leader Tube (0.153" ID x 0.279" OD x 0.063" Wall)								
◇ SFH0324	4mm Leader Tube 24" for 4mm Barb Stake	Call Toro Micro-Irrigation Customer Service						
SFH0330	4mm Leader Tube 30" for 4mm Barb Stake							
◇ SFH0336	4mm Leader Tube 36" for 4mm Barb Stake							
◇ SFH0348	4mm Leader Tube 48" for 4mm Barb Stake							
LLDPE Leader Tube (0.250" ID x 0.346" OD x 0.048" Wall)								
◇ SFH0624	6mm Leader Tube 24" for 6mm Barb Stake	100	20,000	500.00	226.80	54.90	1.554	0.24
◇ SFH0630	6mm Leader Tube 30" for 6mm Barb Stake	100	15,000	750.00	340.20	54.90	1.554	0.29
◇ SFH0636	6mm Leader Tube 36" for 6mm Barb Stake	100	15,000	850.00	385.60	54.90	1.554	0.35
◇ SFH0648	6mm Leader Tube 48" for 6mm Barb Stake	100	10,000	600.00	272.20	54.90	1.554	0.47

Ordering Information:

◇ = MADE TO ORDER. 1,000 minimum order quantity will apply. Please consult Toro Micro-Irrigation Customer Service for availability.

Accessories

Miscellaneous Accessories (Category VIII)

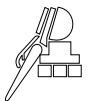

Part Number	Description	Quantity		Carton Weight		Carton Cube		List Price Each
		Bag	Carton	Lbs.	Kilos	Ft.	M.	
Gauges								
GPP04	Air chuck adapter	—	10	—	—	—	—	24.60
GPM0100	0-100 psi Pressure Gauge, 1/4" MPT	—	96	—	—	—	—	47.10
Schrader Valves								
GPV01	1/4" MNPT Schrader Valve	—	10	—	—	—	—	7.36
GPV02-01	1/8" MNPT Schrader Valve* <i>*use a 21/64" or "R" size drill bit and a 1/8" NPT tap</i>	—	10	—	—	—	—	5.77
Accessories								
A-995-01	Flow Gauge	1	—	—	—	—	—	110.00
◇ A-5-309	Gauge (Flow Gauge)	1	—	—	—	—	—	35.00
◇ A-53693	Poly Hose Cutter	Call Toro Micro-Irrigation Customer Service						
Groove Connectors								
ZCP9531-03	3" Grooved Connector	—	1	3.20	1.50	0.02	0.001	36.00
ZCP9531-04	4" Grooved Connector	—	1	3.70	1.70	0.02	0.001	43.00
IKA01100	Adapter 4" Grooved x Spigot	—	1	1.00	0.45	0.09	0.003	43.00

Ordering Information:

◇ = MADE TO ORDER. Minimum order quantity will apply. Please consult Toro Micro-Irrigation Customer Service for availability.





Chemical Injection

Chemical Injection

Mazzei® Injectors® NPT Thread (Category VIII)

for Fertigation / Chemigation with no Moving Parts

Water Suction Capacity with inlet pressure at 50 psi & outlet pressure at 0 psi

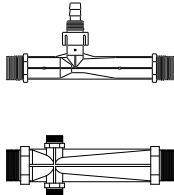

Part Number	Description	Quantity		Carton Weight		Carton Cube		List Price Each
		Box	Carton	Lbs.	Kilos	Ft.	M.	
Mazzei Injectors PVDF with NPT Thread								
AIV283	1/2" MNPT PVDF, 6.0 gph (22.7 lph) Suction	1	—	0.100	0.045	0.01	0.001	60.80
AIV287	1/2" MNPT PVDF, 8.3 gph (31.4 lph) Suction	1	—	0.100	0.045	0.01	0.001	60.80
AIV384	1/2" MNPT PVDF, 14.1 gph (53.4 lph) Suction	1	—	0.172	0.078	1.69	0.048	68.40
AIV384X	1/2" MNPT PVDF 33.9 gph (128.4 lph) Suction	1	—	0.13	0.061	1.69	0.048	68.40
AIV484	1/2" MNPT PVDF, 17.4 gph (65.9 lph) Suction	1	—	0.174	0.079	1.69	0.048	62.20
AIV584C	1/2" MNPT PVDF, 25.6 gph (96.9 lph) Suction	1	—	0.176	0.080	1.69	0.048	68.40
AIV484A	3/4" MNPT PVDF, 17.4 gph (65.9 lph) Suction	1	—	0.206	0.093	1.69	0.048	68.40
AIV484X	3/4" MNPT PVDF, 41.7 gph (157.8 lph) Suction	1	—	0.206	0.093	1.69	0.048	68.40
AIV584	3/4" MNPT PVDF, 25.6 gph (96.9 lph) Suction	1	—	0.200	0.091	1.69	0.048	68.40
AIV684	3/4" MNPT PVDF, 25.0 gph (94.6 lph) Suction	1	—	0.204	0.093	1.69	0.048	68.40
AIV784	3/4" MNPT PVDF, 31.2 gph (118.1 lph) Suction	1	—	0.204	0.093	1.69	0.048	68.40
AIV878	1" MNPT PVDF, 74.8 gph (283.1 lph) Suction	1	—	0.530	0.240	3.09	0.088	134.00
AIV885X	1" MNPT PVDF, 139.6 gph (528.4 lph) Suction	1	—	0.530	0.240	3.09	0.088	134.00
AIV1078-02	1" MNPT PVDF, 92.4 gph (349.7 lph) Suction	1	—	0.526	0.239	3.09	0.088	134.00
AIV1583A	1-1/2" MNPT PVDF, 227.4 gph (860.7 lph) Suction	1	—	0.950	0.431	8.48	0.240	192.00
AIV1585X	1-1/2" MNPT PVDF, 323.0 gph (1,222.6 lph) Suction	1	—	0.990	0.449	8.48	0.240	192.00
AIV1587	1-1/2" MNPT PVDF, 260.5 gph (986.0 lph) Suction	1	—	0.990	0.449	8.48	0.240	192.00
AIV2081A	2" MNPT PVDF, 631.0 gph (2,388.3 lph) Suction	1	—	1.340	0.608	9.64	0.273	350.00
AIV2083X	2" MNPT PVDF, 1,175.0 gph (4,447.3 lph) Suction	1	—	1.472	0.668	9.64	0.273	416.00
AIV3090	3" MNPT PVDF, 1,236.0 gph (4,678.3 lph) Suction	1	—	4.120	1.869	44.11	1.249	1,410.00
AIV4091	4" MNPT PVDF, 2,820.0 gph (10,673.7 lph) Suction	1	—	10.120	4.590	179.31	5.078	2,750.00

Mazzei Injectors Polypropylene with NPT Thread

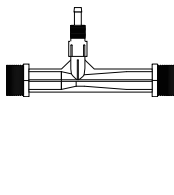

AIV283-P	1/2" MNPT Poly, 6.0 gph (22.7 lph) Suction	1	—	0.07	0.031	0.01	0.001	37.70
AIV287-P	1/2" MNPT Poly, 8.3 gph (31.4 lph) Suction	1	—	0.07	0.031	0.01	0.001	37.70
AIV384-P	1/2" MNPT Poly, 14.1 gph (53.4 lph) Suction	1	—	0.13	0.057	1.69	0.048	53.70
AIV384X-P	1/2" MNPT Poly 33.9 gph (128.4 lph) Suction	1	—	0.13	0.061	1.69	0.048	53.70
AIV484-P	1/2" MNPT Poly, 17.4 gph (65.9 lph) Suction	1	—	0.13	0.061	1.69	0.048	53.70
AIV584C-P	1/2" MNPT Poly, 25.6 gph (96.9 lph) Suction	1	—	0.14	0.062	1.69	0.048	53.70
AIV484A-P	3/4" MNPT Poly, 17.4 gph (65.9 lph) Suction	1	—	0.15	0.070	1.69	0.048	53.70
AIV584-P	3/4" MNPT Poly, 25.6 gph (96.9 lph) Suction	1	—	0.15	0.070	1.69	0.048	50.60
AIV878-P	1" MNPT Poly, 74.8 gph (283.1 lph) Suction	1	—	0.34	0.156	3.09	0.088	87.80
AIV885X-P	1" MNPT Poly, 139.6 gph (528.4 lph) Suction	1	—	0.34	0.154	3.09	0.088	87.80
AIV1078-P	1" MNPT Poly, 92.4 gph (349.7 lph) Suction	1	—	0.34	0.155	3.09	0.088	87.80
AIV1583A-P	1-1/2" MNPT Poly, 227.4 gph (860.7 lph) Suction	1	—	0.65	0.297	8.48	0.240	109.00
AIV1585X-P	1-1/2" MNPT Poly, 323.0 gph (1,222.6 lph) Suction	1	—	0.71	0.321	8.48	0.240	128.00
AIV1587-P	1-1/2" MNPT Poly, 260.5 gph (986.0 lph) Suction	1	—	0.71	0.321	8.48	0.240	128.00
AIV2081A-P	2" MNPT Poly, 631.0 gph (2,388.3 lph) Suction	1	—	0.88	0.397	9.64	0.273	152.00
AIV2083X-P	2" MNPT Poly, 1,175.0 gph (4,447.3 lph) Suction	1	—	0.88	0.397	9.64	0.273	233.00

Mazzei® Injectors® BSP Thread (Category VIII)

for Fertigation / Chemigation with no Moving Parts

Water Suction Capacity with inlet pressure at 50 psi & outlet pressure at 0 psi

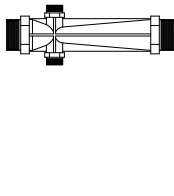

Part Number	Description	Quantity		Carton Weight		Carton Cube		List Price Each
		Box	Carton	Lbs.	Kilos	Ft.	M.	
Mazzei Injectors PVDF with BSP Thread								
AIC484A	3/4" MBSP PVDF, 17.4 gph (65.9 lph) Suction	1	—	0.210	0.095	1.69	0.048	68.40
AIC484X	3/4" MBSP PVDF, 41.7 gph (157.8 lph) Suction	1	—	0.206	0.093	1.69	0.048	68.40
AIC584	3/4" MBSP PVDF, 25.6 gph (96.9 lph) Suction	1	—	0.208	0.094	1.69	0.048	68.40
AIC684	3/4" MBSP PVDF, 25.0 gph (94.6 lph) Suction	1	—	0.208	0.094	1.69	0.048	68.40
AIC878	1" MBSP PVDF, 74.8 gph (283.1 lph) Suction	1	—	0.540	0.245	3.09	0.088	134.00
AIC885X	1" MBSP PVDF, 139.6 gph (528.4 lph) Suction	1	—	0.538	0.244	3.09	0.088	134.00
AIC1078	1" MBSP PVDF, 92.4 gph (349.7 lph) Suction	1	—	0.526	0.239	3.09	0.088	134.00
AIC1583A	1-1/2" MBSP PVDF, 227.4 gph (860.7 lph) Suction	1	—	0.950	0.431	8.48	0.240	192.00
AIC1585X	1-1/2" MBSP PVDF, 323.0 gph (1,222.6 lph) Suction	1	—	0.902	0.409	8.48	0.240	192.00
AIC1587	1-1/2" MBSP PVDF, 260.5 gph (986.0 lph) Suction	1	—	0.990	0.449	8.48	0.240	192.00
AIC2081A	2" MBSP PVDF, 631.0 gph (2,388.3 lph) Suction	1	—	1.340	0.608	9.64	0.273	350.00
AIC2083X	2" MBSP PVDF, 1,175.0 gph (4,447.3 lph) Suction	1	—	1.340	0.608	9.64	0.273	416.00
AIC3090	3" MBSP PVDF, 1,236.0 gph (4,678.3 lph) Suction	1	—	4.140	1.878	44.11	1.249	1,570.00
AIC4091	4" MBSP PVDF, 2,820.0 gph (10,673.7 lph) Suction	1	—	10.380	4.708	179.31	5.078	2,750.00
Mazzei Injectors Polypropylene with BSP Thread								
AIC584-PPG	3/4" MBSP Poly, 25.6 gph (96.9 lph) Suction	1	—	0.15	0.070	1.69	0.048	47.90
AIC885X-PPG	1" MBSP Poly, 139.6 gph (528.4 lph) Suction	1	—	0.34	0.154	3.09	0.088	89.90
AIC1078-PPG	1" MBSP Poly, 92.4 gph (349.7 lph) Suction	1	—	0.34	0.155	3.09	0.088	87.80
AIC1583A-PPG	1-1/2" MBSP Poly, 227.4 gph (860.7 lph) Suction	1	—	0.65	0.297	8.48	0.240	109.00
AIC2081-PPG	2" MBSP Poly, 631.0 gph (2,388.3 lph) Suction	1	—	—	—	9.64	0.273	249.00

Note: 1/2" NPT threads are compatible with 1/2" BSP thread



Chemical Injection Accessories

Mazzei® Injector® Accessories (Category VIII)

Part Number	Description	Quantity		Carton Weight		Carton Cube		List Price Each
		Box	Carton	Lbs.	Kilos	Ft.	M.	
Suction Line Kits								
AAK184	Suction line kit For 1/2" and 3/4" injectors	1	—	0.48	0.22	0.07	0.002	71.10
AAK183	Suction line kit For 1" & 1-1/2" injectors	1	—	1.66	0.75	0.17	0.005	159.00
AAK282	Suction line kit For 2" injectors	1	—	5.46	2.48	—	—	279.00
Bypass & Suction Line Kits								
AAK184-A	Bypass and suction line kit For 1/2" injectors	1	—	1.66	0.75	0.17	0.005	141.00
AAK184-B	Bypass and suction line kit For 3/4" injectors	1	—	1.96	0.89	0.17	0.005	143.00
AAK181-A02	Bypass and suction line kit For 1" injectors	1	—	3.92	1.78	0.28	0.008	277.00
AAK183-A	Bypass and suction line kit For 1.5" injectors	1	—	6.02	2.73	0.74	0.021	277.00
AAK282-A	Bypass and suction line kit For 2" injectors	1	—	9.82	4.46	1.28	0.036	468.00
Caps								
ACAP-PP	Suction port cap for Models 283 & 287	1	—	—	—	—	—	1.95
ACAP-PP050	Suction port cap for C83-PP & old-style 1.0" injectors	1	—	—	—	—	—	7.27
ACAP-PP375	Injector replacement caps for models 384-584	1	—	—	—	—	—	4.08
ACAP075	Suction port cap for new-style (-02) 1.0" & 1.5" injectors	1	—	—	—	—	—	8.37
ACAP-PVDF025	Suction port cap for PVDF 0.50" & 0.75" injectors (excluding 283 & 287)	1	—	—	—	—	—	5.94
Check Valves								
ACP83	1/2" PVDF check valve for old style 1" PVDF injector (not -02* style)	1	—	0.06	0.03	—	—	40.60
ACP83-P	1/2" Poly check valve for old style 1" Poly injector (not -02* style)	1	—	0.04	0.02	—	—	23.50
ACP86	PVC check valve used with 2" injector	1	—	0.78	0.35	—	—	43.50
ACP75-CVA	PVC check valve used with 2" injector with hose barb	1	—	0.48	0.22	—	—	43.30
Check valves repair kits								
ACR-1	Check valve repair kit for injectors 283 and 287	1	—	—	—	—	—	10.50
ACR-2	Check valve repair kit for injectors 1/2" and 3/4" injectors (excluding 283 and 287)	1	—	—	—	—	—	12.00
ACR-3	Check valve repair kit for ACP83, ACP83-P and old style 1" injectors (not -02* style)	1	—	—	—	—	—	14.40
ACR-4	Check valve repair kit for new style (-02*) 1" & 1-1/2" injector	1	—	—	—	—	—	19.30
Metering valves								
AVHV-5	0.50" Metering valve for 1.0" & 1.5" injectors - Polypropylene	1	—	—	—	—	—	124.00
AVHV-5-PVDF	0.50" Metering valve for 1.0" & 1.5" injectors - PVDF	1	—	—	—	—	—	202.00
AVHV-25	Metering valves for suction lines for 1/2" and 3/4" injectors	1	—	0.04	0.02	—	—	59.50
AVHV-50	Metering valves for suction lines for 1" and 1.5" injectors	1	—	0.22	0.10	—	—	261.00
Strainers								
AS-25HB	1/4" Hose Barb Integral Strainer	1	—	—	—	—	—	14.00
AS-50HB	1/2" Hose Barb Integral Strainer	1	—	—	—	—	—	14.00
AS-84	Strainer for suction lines, less tubing adapter	1	—	—	—	—	—	25.80
AS-84006	Strainer with 1/4" Barb for suction lines for 1/2" and 3/4" injectors	1	—	0.04	0.02	—	—	28.10
AS-84095	Strainer with 3/8" Barb for suction lines for old style 1" injectors	1	—	0.04	0.02	—	—	28.10
AS-84FV	Strainer with foot valve, 3/8" Barb & 1/2" MNPT for suction lines for 1" injectors	1	—	0.06	0.03	—	—	49.30
AS-84120	Strainer for suction lines for 1" and 1.5" injectors	1	—	0.04	0.02	—	—	28.10
AS-87	PVC strainer for 1" suction lines used on 2" injectors	1	—	0.02	0.01	—	—	17.30

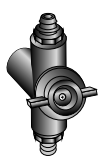

Note: *New style 1" injector has -02 molded on the body
 Note: Other Injector options and configurations also available. For inquiries, please contact Toro Micro-Irrigation Customer Service.

Ordering Information:

Shaded area indicates products being discontinued. Limited to available stocks on hand.

Bypass and Suction Line Kit:

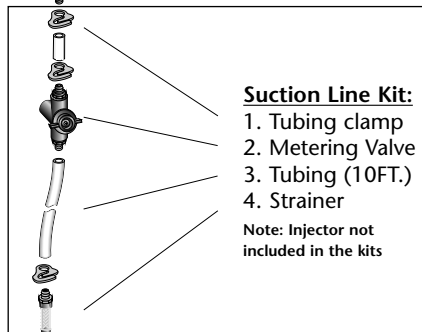
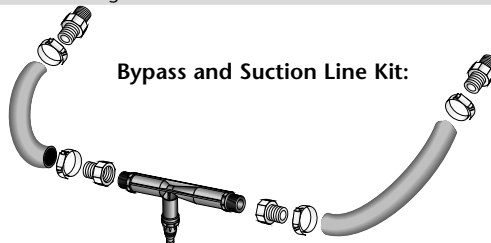

Suction Line Kit:
 1. Tubing clamp
 2. Metering Valve
 3. Tubing (10FT.)
 4. Strainer
 Note: Injector not included in the kits



To order, call Toro Micro-Irrigation
 El Cajon, Ca: +1 (800) 333-8125 or +1 (619) 562-2950
 Sanford, Fl: +1 (800) 806-6582 or +1 (407) 321-2901
 List Prices are US\$. FOB Shipping Point. Effective November 19, 2014 (ALT002)



Valves

Valves

Standard Electric Valves (Category VI)

Part Number	Description	Size	Flow Rate gpm		Quantity Carton	Carton Weight		Carton Cube		List Price Each
			From	To		Lbs.	Kilos	Ft.	M.	
PVC Valves										
A-2400TF	1" Globe valve, flow control, threaded bonnet, 24VAC	1"	0.25	30	20	17.00	7.70	1.20	0.034	25.00
A-2500TF	1" Globe valve, flow control, 24VAC	1"	0.25	30	20	19.00	8.60	1.20	0.034	33.50
A-205T	1" Globe Valve, 24VAC	1"	0.25	30	20	18.00	8.10	1.20	0.034	30.00
A-205TF	1" Globe Valve, Flow Control, 24VAC	1"	0.25	30	20	19.00	8.60	1.20	0.034	32.50
A-216B	1 1/2" Globe / angle valve, flow control, 24VAC	1 1/2"	20	80	10	19.00	8.60	1.20	0.034	101.00
A-217B	2" Globe / angle valve, flow control, 24VAC	2"	20	120	10	26.98	12.20	2.90	0.082	148.00
100 Series										
A-100P1	Globe/angle electric 24VAC internally ported, normally closed valves with manual bleed assembly and adjustable flow control.(*)	1"	10	50	24	23.00	10.00	2.30	0.065	113.00
A-100P1.5		1 1/2"	30	110	12	27.00	12.00	1.20	0.034	152.00
A-100P2		2"	80	150	4	11.00	5.00	2.90	0.082	214.00
A-100P3		3"	150	300	4	21.00	10.00	1.60	0.045	373.00
700 Series										
A-700B-.75	Globe electric 24VAC internally ported, normally closed valves with manual bleed assembly and adjustable flow control.(*)	3/4"	2	30	12	15.00	7.00	1.20	0.034	43.00
A-700-1		1"	2	50	24	20.00	9.00	1.20	0.034	107.00
A-700-1.5		1 1/2"	15	140	12	20.00	9.00	1.60	0.045	152.00
A-700-2		2"	30	180	8	25.00	11.00	1.80	0.050	209.00
Sentinel™ Series										
VPR10107	Angle electric 24VAC externally ported, normally closed valve with manual bleed assembly.	4"	100	1,000	4	27.00	12.00	2.00	0.057	524.00

Manual Valves (Category VI)

Part Number	Description	Size	Flow Rate gpm		Quantity Carton	Carton Weight		Carton Cube		List Price Each
			From	To		Lbs.	Kilos	Ft.	M.	
707PR	Manual Plastic Angle Valve	1"	—	—	20	12.00	5.40	1.42	0.040	18.20
Sentinel™ Series										
VPR30100	Angle manual externally ported valve.	4"	100	1,000	4	28.00	13.00	2.00	0.057	536.00

Anti-Contamination Valves (Category VI)

Part Number	Description	Size	Flow Rate gpm		Quantity Carton	Carton Weight		Carton Cube		List Price Each
			From	To		Lbs.	Kilos	Ft.	M.	
102 Anti-Contamination Series										
A-102P1	Anti-Contamination, globe/angle electric 24VAC externally ported, normally closed valves with 3-way pilot, external filter, manual bleed assembly and adj. flow control.(*)	1"	10	50	6	7.00	3.00	1.60	0.045	174.00
A-102P1.5		1 1/2"	30	110	6	9.00	4.00	1.60	0.045	205.00
A-102P2		2"	80	150	2	9.00	4.00	1.60	0.045	273.00
A-102P3		3"	150	300	2	11.00	5.00	1.60	0.045	467.00

Hydraulic Valves (Category VI)

Part Number	Description	Size	Flow Rate gpm		Quantity Carton	Carton Weight		Carton Cube		List Price Each
			From	To		Lbs.	Kilos	Ft.	M.	
600 Series										
600-3-T-00	Globe/angle manual externally ported, normally closed hydraulic valves with adjustable flow control.									
600-2-T-01	Globe/angle electric 24VAC externally ported, normally closed hydraulic valves with adjustable flow control.									
600-3-T-01	Globe/angle electric 24VAC externally ported, normally closed hydraulic valves with adjustable flow control.									
Call Toro Micro-Irrigation Customer Service										

Ordering Information:

(*) Available with BSP thread & 50hz solenoid. Please add -BSP to the part number (example: A-100P1.5-BSP)

◇ = MADE TO ORDER. Please consult Toro Micro-Irrigation Customer Service for availability.

Shaded area indicates products being discontinued. Limited to available stocks on hand.



Valves

Pressure Regulating Valves - Electric / Manual (Category VI)

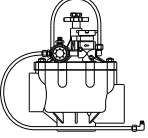
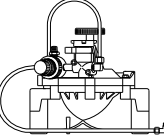
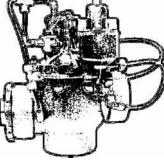
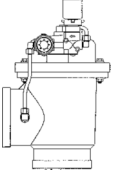
Part Number	Description	Size	Pressure Regulation	Flow Rate gpm		Quantity Carton	Carton Weight		Carton Cube		List Price Each
				From	To		Lbs.	Kilos	Ft.	M.	
213 Series											
 213P1-30DS	Globe/angle manual pressure regulating internally ported, normally closed valves with downstream sensing and adjustable flow control (***)	1"	0-30 psi	10	50	24	33	15	2.3	0.065	228.00
213P1.5-30DS		1 1/2"	0-30 psi	30	110	12	20	9	1.2	0.034	267.00
213P2-30DS		2"	0-30 psi	80	175	8	44	20	2.9	0.082	329.00
213P3-30DS		3"	0-30 psi	150	300	4	22	10	1.6	0.045	488.00
213P1-100DS		1"	0-100 psi	10	50	24	33	15	2.3	0.065	228.00
213P1.5-100DS		1 1/2"	0-100 psi	30	110	12	20	9	1.2	0.034	267.00
213P2-100DS		2"	0-100 psi	80	175	8	44	20	2.9	0.082	329.00
213P3-100DS		3"	0-100 psi	150	300	4	22	10	1.6	0.045	488.00
713 Series											
 713-1-30DS	Globe manual pressure regulating internally ported, normally closed valves with downstream sensing and adjustable flow control (***)	1"	0-30 psi	2	50	24	24.00	11.00	1.20	0.034	206.00
713-1.5-30DS		1 1/2"	0-30 psi	15	140	12	37.00	17.00	1.60	0.045	246.00
713-2-30DS		2"	0-30 psi	30	180	8	25.00	11.00	1.80	0.050	300.00
713-1-100DS		1"	0-100 psi	2	50	24	24.00	11.00	1.20	0.034	206.00
713-1.5-100DS		1 1/2"	0-100 psi	15	140	12	37.00	17.00	1.60	0.045	246.00
713-2-100DS		2"	0-100 psi	30	180	8	25.00	11.00	1.80	0.050	300.00
(***) To convert valve to in-valve sensing a 2-Prong Adapter part # R2658 is required. (***) To convert valve to electric 24VAC a solenoid part #R811-24VACG is required.											
601 Series											
 601-2-T-00-B	Globe/angle manual externally ported, normally closed pressure regulating valves with 3-way pilot and adjustable flow control.										
601-3-T-00-B											
601-3-T-00-G											
601-3-T-00-S											
Call Toro Micro-Irrigation Customer Service											
601-3-T-01-B	Globe/angle electric 24VAC externally ported, normally closed pressure regulating valves with 3-way pilot and adjustable flow control.										
601-3-T-01-G											
601-3-T-01-S											
Sentinel™ Series											
 VPR31100-30	Angle manual externally ported, normally closed pressure regulating valves.	4"	0-30 psi	100	1,000	4	30.00	14.00	2.00	0.057	626.00
VPR31100-100		4"	0-100 psi	100	1,000	4	30.00	14.00	2.00	0.057	626.00
VPR11107-30	Angle electric 24VAC externally ported, normally closed pressure regulating valves.	4"	0-30 psi	100	1,000	4	30.00	14.00	2.00	0.057	652.00
VPR11107-100		4"	0-100 psi	100	1,000	4	30.00	14.00	2.00	0.057	652.00

Ordering Information:

Shaded area indicates products being discontinued. Limited to available stocks on hand.



Valves

Plastic Y Pattern Valves - Electric / Manual, Pressure Reducing and Pressure Sustaining (Category XII)

Part Number	Description	Size	Connection	Operating Range	Flow Rate gpm		Quantity Carton	Carton Weight		Carton Cube		List Price Each
					From	To		Lbs.	Kilos	Ft.	M.	
105 Series - Manual												
B105-Z-02-Y-NP	Manually controlled Y pattern valves, actuated hydraulically, with 3-way on off selector.	2"	Thread	5-145 psi	35	140	5	17.5	8.00	1.3	0.04	150.00
B105-Z-03-Y-NP		3"	Thread	5-145 psi	35	300	4	16	7.60	1.8	0.05	190.00
B105-Z-03L-Y-NP		3L"	Thread	5-145 psi	75	580	2	15.2	7.00	1.4	0.04	405.00
B105-Z-03L-Y-T3		3L"	Glue End	5-145 psi	75	580	2	15.2	7.00	1.4	0.04	441.00
B105-Z-03L-Y-VI		3L"	Grooved	5-145 psi	75	580	2	15.20	7	1.4	0.04	441.00
B105-Z-03L-Y-FF		3L"	Flange	5-145 psi	75	580	2	15.20	7	1.4	0.04	441.00
B105-Z-04-Y-T4		4"	Glue End	5-145 psi	75	580	1	20.00	9	1.4	0.04	508.00
B105-Z-04-Y-VI		4"	Grooved	5-145 psi	75	580	1	20.00	9	1.4	0.04	508.00
B105-Z-04-Y-FF		4"	Flange	5-145 psi	75	580	1	20	9.00	1.4	0.04	508.00
B105-Z-06-Y-VI		6"	Grooved	5-145 psi	140	1000	1	32.00	15.5	5.2	0.15	1,467.00
B105-Z-06-Y-FF	6"	Flange	5-145 psi	140	1000	1	32	15.50	5.2	0.15	1,467.00	
110 Series - Electric												
B110-3W-02-Y-NP	Solenoid controlled Y pattern valves, actuated hydraulically, in response to a 24 VAC electric signal or manually operate using override on Solenoid.	2"	Thread	5-145 psi	35	140	5	17.7	8.00	1.3	0.04	195.00
B110-3W-03-Y-NP		3"	Thread	5-145 psi	35	300	4	16	7.60	1.8	0.05	289.00
B110-3W-03L-Y-NP		3L"	Thread	5-145 psi	75	580	2	15.2	7.00	1.4	0.04	478.00
B110-3W-03L-Y-T3		3L"	Glue End	5-145 psi	75	580	2	15.20	7	1.4	0.04	512.00
B110-3W-03L-Y-VI		3L"	Grooved	5-145 psi	75	580	2	15.20	7	1.4	0.04	512.00
B110-3W-03L-Y-FF		3L"	Flange	5-145 psi	75	580	2	15.20	7	1.4	0.04	512.00
B110-3W-04-Y-T4		4"	Glue End	5-145 psi	75	580	1	20.00	9	1.4	0.04	579.00
B110-3W-04-Y-VI		4"	Grooved	5-145 psi	75	580	1	20.00	9	1.4	0.04	579.00
B110-3W-04-Y-FF		4"	Flange	5-145 psi	75	580	1	20	9.00	1.4	0.04	579.00
B110-3W-06-Y-VI		6"	Grooved	5-145 psi	140	1000	1	32.00	15.5	5.2	0.15	1,484.00
B110-3W-06-Y-FF	6"	Flange	5-145 psi	140	1000	1	32	15.50	5.2	0.15	1,484.00	
120 Series - Pressure Reducing, Manual												
B120-XZ-02-Y-NP-K	Pressure Regulating Manually controlled Y pattern valves. Reduces high upstream pressure to lower constant down stream pressure. Manual on off with 3 way selector. (*)	2"	Thread	5-145 psi	35	140	5	17.5	8.00	1.3	0.04	311.00
B120-XZ-03-Y-NP-K		3"	Thread	5-145 psi	35	300	4	16.00	7.6	1.8	0.05	370.00
B120-XZ-03L-Y-T3-K		3L"	Glue End	5-145 psi	75	480	2	15.20	7	1.4	0.04	590.00
B120-XZ-03L-Y-VI-K		3L"	Grooved	5-145 psi	75	480	2	15.20	7	1.4	0.04	590.00
B120-XZ-03L-Y-FF-K		3L"	Flange	5-145 psi	75	480	2	15.20	7	1.4	0.04	590.00
B120-XZ-04-Y-T4-K		4"	Glue End	5-145 psi	75	500	1	20.00	9	1.4	0.04	654.00
B120-XZ-04-Y-VI-K		4"	Grooved	5-145 psi	75	500	1	20.00	9	1.4	0.04	654.00
B120-XZ-04-Y-FF-K		4"	Flange	5-145 psi	75	500	1	20.00	9	1.4	0.04	654.00
B120-XZ-06-Y-VI-K		6"	Grooved	5-145 psi	140	1000	1	32.00	15.5	5.2	0.15	1,498.00
B120-XZ-06-Y-FF-K		6"	Flange	5-145 psi	140	1000	1	32.00	15.5	5.2	0.15	1,498.00
12055 Series - Pressure Reducing, Electric												
B12055-X-02-Y-NP-K	Pressure Regulating, Electrically controlled Y pattern valves. Reduces high upstream pressure to lower constant down stream pressure. Opens and closes in response to 24 VAC electric or manually operated using override on solenoid. (*)	2"	Thread	5-145 psi	35	140	5	17.5	8.00	1.3	0.04	342.00
B12055-X-03-Y-NP-K		3"	Thread	5-145 psi	35	300	4	16.00	7.6	1.8	0.05	407.00
B12055-X-03L-Y-NP-K		3L"	Thread	5-145 psi	75	500	2	15.2	7.00	1.4	0.04	585.00
B12055-X-03L-Y-T3-K		3L"	Glue End	5-145 psi	75	480	2	15.20	7	1.4	0.04	619.00
B12055-X-03L-Y-VI-K		3L"	Grooved	5-145 psi	75	480	2	15.20	7	1.4	0.04	619.00
B12055-X-03L-Y-FF-K		3L"	Flange	5-145 psi	75	480	2	15.20	7	1.4	0.04	619.00
B12055-X-04-Y-T4-K		4"	Glue End	5-145 psi	75	500	1	20.00	9	1.4	0.04	679.00
B12055-X-04-Y-VI-K		4"	Grooved	5-145 psi	75	500	1	20.00	9	1.4	0.04	679.00
B12055-X-04-Y-FF-K		4"	Flange	5-145 psi	75	500	1	20.00	9	1.4	0.04	679.00
B12055-X-06-Y-VI-K		6"	Grooved	5-145 psi	140	1000	1	32.00	15.5	5.2	0.15	1,483.00
B12055-X-06-Y-FF-K	6"	Flange	5-145 psi	140	1000	1	32.00	15.5	5.2	0.15	1,483.00	
130 Series - Pressure Sustaining, Manual												
B130-XZ-02-Y-NP	Pressure Sustaining, Manually controlled globe valve. Maintains preset minimum upstream pressure in fluctuating flows or varying downstream pressure conditions.	2"	Thread	5-145 psi	35	140	5	17.5	8.00	1.3	0.04	306.00
B130-XZ-03-Y-NP		3"	Thread	5-145 psi	35	300	4	16	7.60	1.8	0.05	370.00
B130-XZ-03L-Y-NP		3L"	Thread	5-145 psi	75	500	2	15.2	7.00	1.4	0.04	554.00
B130-XZ-04-Y-FF		4"	Flange	5-145 psi	75	500	1	20	9.00	1.4	0.04	654.00
B130-XZ-06-Y-FF		6"	Flange	5-145 psi	140	1000	1	32	15.50	5.2	0.15	1,498.00

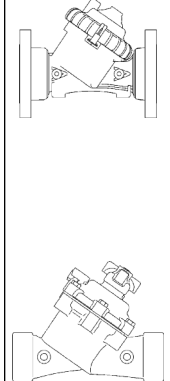

To order, call Toro Micro-Irrigation
 El Cajon, Ca: +1 (800) 333-8125 or +1 (619) 562-2950
 Sanford, Fl: +1 (800) 806-6582 or +1 (407) 321-2901
 List Prices are US\$. FOB Shipping Point. Effective November 19, 2014 (ALT002)

Valves

Plastic Angle Pattern Valves - Electric / Manual, Pressure Regulating (Category XII)

Part Number	Description	Size	Connection	Operating Range	Flow Rate gpm		Quantity Carton	Carton Weight		Carton Cube		List Price Each
					From	To		Lbs.	Kilos	Ft.	M.	
105 Series - Manual												
B105-Z-03-A-NP	Manually controlled angle valves, actuated hydraulically, with 3-way on off selector.	3"	Thread	5-145 psi	35	300	4	16.00	7.6	1.8	0.05	190.00
B105-Z-03L-A-T3		3L"	Glue End	5-145 psi	75	580	2	15.20	7	1.4	0.04	441.00
B105-Z-03L-A-VI		3L"	Grooved	5-145 psi	75	580	2	15.20	7	1.4	0.04	441.00
B105-Z-03L-A-FF		3L"	Flange	5-145 psi	75	580	2	15.20	7	1.4	0.04	441.00
B105-Z-04-A-T4		4"	Glue End	5-145 psi	75	580	1	20.00	9	1.4	0.04	508.00
B105-Z-04-A-VI		4"	Grooved	5-145 psi	75	580	1	20.00	9	1.4	0.04	508.00
B105-Z-04-A-FF	4"	Flange	5-145 psi	75	580	1	20.00	9	1.4	0.04	508.00	
110 Series - Electric												
B110-3W-03-A-NP	Solenoid controlled angle valves, actuated hydraulically, in response to a 24 VAC electric signal or manually operate using override on Solenoid.	3"	Thread	5-145 psi	35	300	4	16.00	7.6	1.8	0.05	289.00
B110-3W-03L-A-T3		3L"	Glue End	5-145 psi	75	580	2	15.20	7	1.4	0.04	512.00
B110-3W-03L-A-VI		3L"	Grooved	5-145 psi	75	580	2	15.20	7	1.4	0.04	512.00
B110-3W-03L-A-FF		3L"	Flange	5-145 psi	75	580	2	15.20	7	1.4	0.04	512.00
B110-3W-04-A-T4		4"	Glue End	5-145 psi	75	580	1	20.00	9	1.4	0.04	579.00
B110-3W-04-A-VI		4"	Grooved	5-145 psi	75	580	1	20.00	9	1.4	0.04	579.00
B110-3W-04-A-FF	4"	Flange	5-145 psi	75	580	1	20.00	9	1.4	0.04	579.00	
120 Series - Pressure Regulating, Manual												
B120-XZ-03-A-NP-K	Pressure Regulating Manually controlled angle valves. Reduces high upstream pressure to lower constant down stream pressure. Manual on off with 3 way selector. (*)	3"	Thread	5-145 psi	35	300	4	16.00	7.6	1.8	0.05	370.00
B120-XZ-03L-A-T3-K		3L"	Glue End	5-145 psi	75	480	2	15.20	7	1.4	0.04	590.00
B120-XZ-03L-A-VI-K		3L"	Grooved	5-145 psi	75	480	2	15.20	7	1.4	0.04	590.00
B120-XZ-03L-A-FF-K		3L"	Flange	5-145 psi	75	480	2	15.20	7	1.4	0.04	590.00
B120-XZ-04-A-T4-K		4"	Glue End	5-145 psi	75	500	1	20.00	9	1.4	0.04	654.00
B120-XZ-04-A-VI-K		4"	Grooved	5-145 psi	75	500	1	20.00	9	1.4	0.04	654.00
B120-XZ-04-A-FF-K	4"	Flange	5-145 psi	75	500	1	20.00	9	1.4	0.04	654.00	
12055 Series - Pressure Regulating, Electric												
B12055-X-03-A-NP-K	Pressure Regulating, Electrically controlled angle valve. Reduces high upstream pressure to lower constant down stream pressure. Opens and closes in response to 24 VAC electric or manually operated using override on solenoid. (*)	3"	Thread	5-145 psi	35	300	4	16.00	7.6	1.8	0.05	427.00
B12055-X-03L-A-T3-K		3L"	Glue End	5-145 psi	75	480	2	15.20	7	1.4	0.04	649.00
B12055-X-03L-A-VI-K		3L"	Grooved	5-145 psi	75	480	2	15.20	7	1.4	0.04	650.00
B12055-X-03L-A-FF-K		3L"	Flange	5-145 psi	75	480	2	15.20	7	1.4	0.04	650.00
B12055-X-04-A-T4-K		4"	Glue End	5-145 psi	75	500	1	20.00	9	1.4	0.04	713.00
B12055-X-04-A-VI-K		4"	Grooved	5-145 psi	75	500	1	20.00	9	1.4	0.04	713.00
B12055-X-04-A-FF-K	4"	Flange	5-145 psi	75	500	1	20.00	9	1.4	0.04	713.00	

Upgrade Options for Plastic Valves (Category XII)

TO UPGRADE A PLASTIC VALVE, ADD THE APPROPRIATE OPTION CODE TO THE END OF THE PART NUMBER.

Option Code	Description	Quantity	List Price Each
-CB	Brass fittings and copper tubing upgrade	1	81.00
-PCM	Brass pilot upgrade for 1 1/2"-4" Valves	1	81.00

Standard Configuration:

- Main Valve, Pilot Valve & Fittings: Plastic
- Pressure rating: 145 psi
- Plastic Flange = ANSI Thread end = NPT
- Remote control electric and hydraulic valves are normally closed
- 2" and 3" with flow control stem

Pilot Spring Options: Optional Pilot springs may be required for peak valve performance. Optional springs are chosen when valves must operate outside the **standard pressure reducing range**.

(*) For valves with model PC-X-P plastic mini pilots

Optional pilot springs are available for 2", 3", 3"L, 4" and 6", 120 and 12055 Series plastic valves. Add the correct spring code to end of part number to receive a pre-install a non-standard spring.

Spring Code	Model- PC-X-P Plastic Mini Pilot Operating Range
K	7-40 psi Standard
H	15-100 psi

Other valve options and configurations are available. For inquires, please consult Toro Micro-Irrigation Customer Service.

Valve Patterns and End Connection Options

Valve Size	Y - Y Pattern	A - Angle Pattern	NP - Thread	FF - Flanged	VI - Grooved	T3 - 3" Glued End	T4 - 4" Glued End
2"	Y		NP		VI		
2"L	Y		NP		VI		
3"	Y	A	NP				
3"L	Y	A	NP	FF	VI	T3	
4"	Y	A		FF	VI		T4
6"	Y			FF	VI		

* Not all available valve configuration and functions can be shown.
* For other valve configurations and application information please call.

When making specification inquiries, please have the following valve information on hand:

- What function do you want the valve to perform?
 - Pressure Reducing or Sustaining, Solenoid Control
- What end fittings do you want on the valve?
 - Threaded, Flanged, or Grooved
- What flow pattern do you want?
 - Globe or Angle
- What flow ranges will the valve operate in?
- What is the inlet pressure range the valve will operate in?
- What is the desired outlet pressure?
- What other options or configurations are required for the valve?
 - Upgrade to Copper Tube and Brass Fittings -CB

Valves

Metal Valves - Electric / Manual, Pressure Reducing and Pressure Relief (Category XII)

Part Number	Description	Size	Connection	Operating Range	Flow Rate gpm		Quantity Carton	Carton Weight		Carton Cube		List Price Each
					From	To		Lbs.	Kilos	Ft.	M.	
405 Series - Manual												
B405-Z-03-G-NP	Manually controlled globe valves, actuated hydraulically, with 3-way on off selector.	3"	Thread	7-232 psi	60	400	1	16	7.30	0.69	0.16	461.00
B405-Z-04-G-A1		4"	Flange	7-232 psi	90	700	1	71	33.00	1.23	0.04	743.00
B405-Z-06-G-A1		6"	Flange	7-232 psi	180	1400	1	175	80.00	-	-	1,675.00
B405-Z-08-G-A1		8"	Flange	7-232 psi	310	2200	1	320	146.00	-	-	2,949.00
B405-Z-10-G-A1		10"	Flange	7-232 psi	340	2400	1	355	162.00	-	-	3,827.00
410 Series - Electric												
B410-X-03-G-NP	Solenoid controlled globe valves, actuated hydraulically, in response to a 24 VAC electric signal or manually operate using override on solenoid.	3"	Thread	7-232 psi	60	400	1	16	7.30	0.7	0.16	537.00
B410-X-04-G-A1		4"	Flange	7-232 psi	90	700	1	71	33.00	1.3	0.04	819.00
B410-X-06-G-A1		6"	Flange	7-232 psi	180	1400	1	175	80.00	-	-	1,847.00
B410-X-08-G-A1		8"	Flange	7-232 psi	310	2200	1	320	146.00	-	-	3,121.00
B410-X-10-G-A1		10"	Flange	7-232 psi	340	2400	1	355	162.00	-	-	3,998.00
420 Series - Pressure Reducing, Manual												
B420-XZ-03-G-NP	Pressure Reducing Manually controlled globe valves. Reduces high upstream pressure to lower constant down stream pressure. Manual on off with 3 way selector. (*,#)	3"	Thread	15-100 psi	60	400	1	16	7.30	0.7	0.16	584.00
B420-XZ-04-G-A1		4"	Flange	15-100 psi	90	700	1	71	33.00	1.3	0.04	865.00
B420-XZ-06-G-A1		6"	Flange	15-230 psi	180	1400	1	175	80.00	-	-	2,145.00
B420-XZ-08-G-A1		8"	Flange	15-230 psi	310	2200	1	320	146.00	-	-	3,419.00
B420-XZ-10-G-A1		10"	Flange	15-230 psi	340	2400	1	355	162.00	-	-	4,297.00
42055 Series - Pressure Reducing, Electric												
B42055-X-03-G-NP	Pressure Reducing, Electrically controlled globe valve. Reduces high upstream pressure to lower constant down stream pressure in response to 24 VAC electric or manually operated using override on solenoid. (*,#)	3"	Thread	15-100 psi	60	400	1	16	7.30	0.7	0.16	712.00
B42055-X-04-G-A1		4"	Flange	15-100 psi	90	700	1	71	33.00	1.3	0.04	994.00
B42055-X-06-G-A1		6"	Flange	15-230 psi	180	1400	1	175	80.00	-	-	2,490.00
B42055-X-08-G-A1		8"	Flange	15-230 psi	310	2200	1	320	146.00	-	-	3,764.00
B42055-X-10-G-A1		10"	Flange	15-230 psi	340	2400	1	355	162.00	-	-	4,641.00

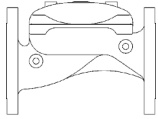

Pressure Relief Valves (Category XII)

Part Number	Description	Size	Connection	Operating Range	Flow Rate gpm		Quantity Carton	Carton Weight		Carton Cube		List Price Each
					From	To		Lbs.	Kilos	Ft.	M.	
430 Series - Pressure Sustaining and Pressure Relief Valves												
B430-KXZ-02-G-NP	Manually controlled 430 Series Valves maintain a preset minimum upstream pressure in fluctuating flow and pressure conditions. 430 Series valves will relieve excessive line pressure when a maximum set point is reached. Angle valves are available in 2", 3" and 4" models.	2"	Thread	7-232 psi	25	180	1	10	4.5	1.3	0.16	318.00
B430-KXZ-03-G-NP		3"	Thread	7-232 psi	60	400	1	33	15	0.7	0.16	584.00
B430-KXZ-04-G-A1		4"	Flange	7-232 psi	90	700	1	71	33	1.3	0.04	865.00
B430-KXZ-06-G-A1		6"	Flange	7-232 psi	180	1400	1	175	80	-	-	2,145.00
B430-KXZ-08-G-A1		8"	Flange	7-232 psi	310	2200	1	320	146	-	-	3,419.00
B430-KXZ-10-G-A1	10"	Flange	7-232 psi	340	2400	1	355	162	-	-	4,297.00	

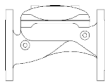

Upgrade Options for Metal Valves (Category XII)

TO UPGRADE A METAL VALVE, ADD THE APPROPRIATE OPTION CODE TO THE END OF THE PART NUMBER.

Option Code	Description	Quantity	List Price Each
-CB	Brass fittings and copper tubing upgrade	1	81.00
-PCM	Brass pilot upgrade for 1 1/2"-4" Valves	1	81.00

Standard Configuration:

- Main Valve: Cast iron
- Standard Rating: max inlet 230 psi
- Valves 1" - 4": Plastic pilots, tubing and fittings
Valves 6" and larger: Nylon tubing, push lock brass fittings and brass pilots
- Schrader gauge fittings and outlet isolation ball valves are furnished standard on all sizes of pressure reducing valves
- Remote control electric and hydraulic valves are normally closed

To ensure correct valve assembly, specify all valve options

Pilot Spring Options: Optional Pilot springs may be required for peak valve performance. Specify the desired spring code for all pilot configurations.

Spring Code	Model- PC-X-P Plastic Mini Pilot Operating Range
K	7-40 psi Standard
H	15-100 psi

(*#) For valves with model PC-X-P plastic mini pilots
Optional pilot springs are available for 3" and 4", 420 and 42055 Series metal valves with plastic mini pilots. Add the correct spring code to the end of the part number to receive the correct pilot spring.

Spring Code	Model X Metal Pilot Operating Range
10	7-150 psi Standard
16	15-230 psi

(#) For metal valves with model X metal pilots
Optional pilot springs are available for 6", 8" and 10", 420 and 42055 Series metal valves with metal pilots. Add the correct spring code to the end of the part number to receive the correct pre-installed pilot spring.

Other valve options and configurations are available. For inquires, please consult Toro Micro-Irrigation Customer Service.



Valves

Plastic Air Release and Vacuum Relief Valves (Category VI)

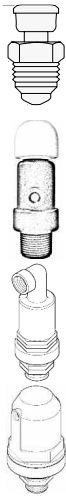

Part Number	Description	Size	Quantity		Carton Weight		Carton Cube		List Price Each
			Bag	Carton	Lbs.	Kilos	Ft.	M.	
1/2" Air Release & Vacuum Relief Valves									
YD-500-34	1/2" Air Release & Vacuum Relief Valves	1/2"	10	—	—	—	—	—	10.80
1" Air Vent with Colored Cap									
ARV-BBK1	1" Air Release & Vacuum Relief Valve with Colored Cap	1"	—	25	5.00	2.30	—	—	9.38
ARV-BBK1-S	1" Air Release & Vacuum Relief Valve with Colored Cap with Installed Schrader Valve	1"	—	25	6.00	3.00	0.40	0.012	18.80
1" & 2" Air Release & Vacuum Relief Valves									
ARV-1-K	Air Release & Vacuum Relief Valve	1"	—	14	12.00	5.40	0.80	0.024	21.50
ARV-2-K		2"	—	8	14.00	6.40	0.80	0.024	42.70
1" & 2" Continuous Air Release & Vacuum Relief Valves									
ARV-1-A	Automatic Continuous Acting Air Release & Vacuum Relief Valve	1"	—	20	15.00	6.70	0.80	0.024	49.40
ARV-2-KA	Combination Large Volume Air Relief and Continuous Acting Air Release & Vacuum Relief Valve	2"	—	8	16.00	7.00	0.80	0.024	121.00

Aluminum Air Vents (Category VI)





Part Number	Description	Size	Quantity		Carton Weight		Carton Cube		List Price Each
			Bag	Carton	Lbs.	Kilos	Ft.	M.	
ARV-1AV	1" Air Vent with Cast Aluminum Body	1"	—	25	—	—	—	—	22.50
ARV-2AV	2" Air Vent with Cast Aluminum Body	2"	—	25	—	—	—	—	43.50
ARV-3AV	3" Air Vent with Cast Aluminum Body	3"	—	10	—	—	—	—	102.00
ARV-4AV	4" Air Vent with Cast Aluminum Body	4"	—	4	—	—	—	—	189.00

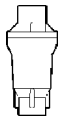



Pressure Regulators (Category VI)

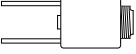
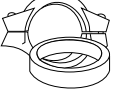

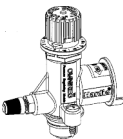
Part Number	Description	Quantity		Carton Weight		Carton Cube		List Price Each
		Bag	Carton	Lbs.	Kilos	Ft.	M.	
Pre-Set Pressure Regulators								
PMR15-LF	3/4"FPT x 3/4"FPT, 15 psi, 1/10-8 gpm Low Flow Pressure Regulator	1	—	—	—	—	—	17.90
PMR25-LF	3/4"FPT x 3/4"FPT, 25 psi, 1/10-8 gpm Low Flow Pressure Regulator	1	—	—	—	—	—	17.90
PMR25-MF	3/4"FPT x 3/4"FPT, 25 psi, 2-20 gpm Medium Flow Pressure Regulator	1	—	—	—	—	—	21.80
PMR40-MF	3/4"FPT x 3/4"FPT, 40 psi, 2-20 gpm Medium Flow Pressure Regulator	1	—	—	—	—	—	21.80
PR25-HF	1-1/4"FPT x 1"FPT, 25 psi, 10-32 gpm High Flow Pressure Regulator	1	—	—	—	—	—	47.20

Valves Accessories

Valve Accessories (Category VIII)									
Part Number	Description	Quantity		Carton Weight		Carton Cube		List Price Each	
		Box	Carton	Lbs.	Kilos	Ft.	M.		
	Accessories A-R811-24VACG Solenoid 24 VAC 60 HZ, .4 amp inrush, 0.2 amp holding	—	120	30.00	13.60	0.71	0.020	17.00	
	Sentinel™ Series 4" Valve - Connectors ZCP9531-04 4" Grooved Connector (2 required for installation with 4" valve.)	—	1	3.70	1.70	0.02	0.001	43.00	
	IKA01100 Adapter 4" Grooved x Spigot (2 required for installation with 4" valve.)	—	1	1.00	0.45	0.09	0.003	43.00	
	OmniReg® Modular Pressure Regulators A-OMR-30 A-OMR-100	1 1	6 6	0.227 0.227	0.103 0.103	1.32 1.32	0.037 0.037	73.50 73.50	
<small>OmniReg® Modular Pressure Regulators maintain downstream pressure regardless of fluctuating upstream pressures. Two models are available: the A-OMR-30 that operates from 5 to 30 PSI and the A-OMR-100 that operates from 5 to 100 PSI. OmniReg® Modular Pressure Regulators are used with 100 Series, 700 Series, 216B and 217B Valves.</small>									

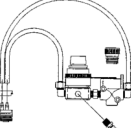
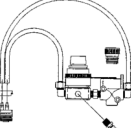
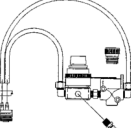
Valve Accessories (Category VIII)									
Part Number	Description	Quantity		Carton Weight		Carton Cube		List Price Each	
		Box	Carton	Lbs.	Kilos	Ft.	M.		
	Accessories R1572 Manual adapter. Used in place of solenoid on manual valves.	—	5	—	—	—	—	12.00	
	HVC-KIT Hydraulic valve conversion kit for Century and Century Plus Series	—	1	—	—	—	—	11.00	
	588403 Solenoid 24 VAC; 50 Hz; 0.4 amp in-rush; 2 amp holding	—	10	—	—	—	—	10.90	
	R576804 Solenoid 24 VDC .24 amp inrush and holding	—	10	—	—	—	—	16.30	
	RW60-KIT Purple solenoid assembly 24 VAC, 60 Hz and warning tag to alert users to reclaimed water	—	10	—	—	—	—	22.00	
	R688601 In-valve sensing pressure regulating assembly 0-30PSI (to use with 100 & 700 series valves)	—	1	—	—	—	—	168.66	
	R688602 In-valve sensing pressure regulating assembly 0-100PSI (to use with 100 & 700 series valves)	—	1	—	—	—	—	163.38	





Controllers

Controllers

KwikDial® Series Controller (Category VII)

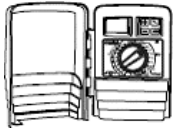

Part Number	Description	Stations	Quantity	Carton Weight		Carton Cube		Pallet Qty.	List Price Each
			Carton	Lbs.	Kilos	Ft.	M.		
A-KD4-EXT	3 independent programs, 9 start times; water budgeting; outdoor mount 120VAC 60/50HZ.	4	6	24.00	11.00	-	-	144	173.00
A-KD6-EXT		6	6	24.00	11.00	-	-	144	201.00
A-KD9-EXT		9	6	24.00	11.00	-	-	144	232.00
A-KD12-EXT		12	6	24.00	11.00	-	-	144	257.00

Rain Dial® Controller (Category VII)



Part Number	Description	Stations	Quantity	Carton Weight		Carton Cube		Pallet Qty.	List Price Each
			Carton	Lbs.	Kilos	Ft.	M.		
A-RD600-EXT-R	3 independent programs, 9 start times, 365-day calendar, non-volatile memory, Rain Sensor ready, outdoor mount 120VAC 60/50HZ. (*)	6	6	32.00	15.00	1.60	0.045	144	236.00
A-RD900-EXT-R		9	6	32.00	15.00	1.60	0.045	144	328.00
A-RD1200-EXT-R		12	6	32.00	15.00	1.60	0.045	144	432.00

Total Control® (Outdoor Mount) Controller (Category VII)



Part Number	Description	Stations	Quantity	Carton Weight		Carton Cube		Pallet Qty.	List Price Each
			Carton	Lbs.	Kilos	Ft.	M.		
A-TC-6EX-R	4 independent programs, 16 start times, Remote ready, outdoor mount 120VAC 60/50HZ. (**)	6	6	34.00	15.00	2.40	0.068	108	331.00
A-TC-9EX-R		9	6	34.00	15.00	2.40	0.068	108	412.00
A-TC-12EX-R		12	6	34.00	15.00	2.40	0.068	108	441.00
A-TC-15EX-R		15	6	34.00	15.00	2.40	0.068	108	515.00
A-TC-18EX-R		18	6	34.00	15.00	2.40	0.068	108	615.00
A-TC-24EX-R	Note: 36 and 48 Station Controllers are pre-installed in metal cabinets	24	6	34.00	15.00	2.40	0.068	108	805.00
A-TC-36EX-R		36	1	20.00	9.00	-	-	-	1,575.00
A-TC-48EX-R		48	1	20.00	9.00	-	-	-	1,800.00

MC-E® Series Controller (Category VII)

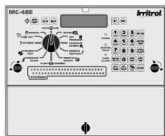

Part Number	Description	Stations	Quantity	Carton Weight		Carton Cube		Pallet Qty.	List Price Each
			Carton	Lbs.	Kilos	Ft.	M.		
A-MC-4E	8 independent programs; looping on all 8 programs; 11 start times per day; advance calendar features; outdoor	4	3	34.00	15.00	1.50	0.042	81	545.00
A-MC-6E		6	3	34.00	15.00	1.50	0.042	81	570.00
A-MC-8E		8	3	34.00	15.00	1.50	0.042	81	700.00
A-MC-12E		12	3	34.00	15.00	1.50	0.042	81	820.00
A-MC-18E		18	1	18.00	8.00	0.70	0.020	64	1,265.00
A-MC-24E		24	1	18.00	8.00	0.70	0.020	64	1,485.00
A-MC-30E		30	1	18.00	8.00	0.70	0.020	64	2,135.00
A-MC-36E		36	1	18.00	8.00	0.70	0.020	64	2,590.00
A-MC-42E		42	1	18.00	8.00	0.70	0.020	64	2,905.00
A-MC-48E	48	1	18.00	8.00	0.70	0.020	64	3,140.00	

Ordering Information:

(*) Also available 220VAC 60/50hz or 240VAC 60/50hz.

- 240VAC 60/50hz. add "-A" to the part number (example: A-RD1200-EXT-A)
- 220VAC 60/50hz. Add "-E" to the part number (example: A-RD1200-EXT-E)

(**) Also available 220VAC 60/50hz or 240VAC 60/50hz.

- 240VAC 60/50hz. add "-50-A" to the part number (example: A-TC-12EX-B-50-A)
- 220VAC 60/50hz. Add "-50-E" to the part number (example: A-TC-12EX-B-50-E)



Controllers

PC Control™ (Category VII)



Part Number	Description	Quantity		Carton Weight		Carton Cube		Pallet Qty.	List Price Each
		Box	Carton	Lbs.	Kilos	Ft.	M.		
A-PC-12-EXT-PAK	Complete 12-Station Outdoor PC Controller Kit (120V)	1	1	5.60	2.54	0.165	0.05	-	595.00
A-PC-12-ADD-EXT	12-Station Outdoor PC Control Add-on Controller(120V)	1	1	4.30	1.95	0.228	0.01	-	380.00
A-PC-R	Complete Remote Control Kit for the PC Control Controller	1	1	4.70	2.13	-	-	-	215.00

IBOC® Plus Controllers - Battery or Solar Operated (Category VII)

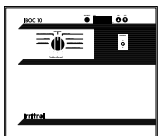

Part Number	Description	Stations	Quantity		Carton Weight		Carton Cube		Pallet Qty.	List Price Each
			Box	Carton	Lbs.	Kilos	Ft.	M.		
A-IBOC-4Plus	3 independent programs, 24 start times, loop cycling, outdoor mount, powered by one-6Volt alkaline battery or solar panel #SPC-2 (Alkaline battery and/or solar panel Not Included) For use with Latching Solenoid (part number: A-DCL).	4	1	11.00	5.00	0.90	0.025	64	1,340.00	
A-IBOC-8Plus		8	1	11.00	5.00	0.90	0.025	64	1,630.00	
A-IBOC-12Plus		12	1	11.00	5.00	0.90	0.025	64	1,810.00	
A-SPC-2	Solar power Converter Kit for IBOC Plus controller		1	6.00	2.70	0.29	0.008	144	820.00	

Junior™ DC - Waterproof Battery-Operated Controllers



Part Number	Description	Stations	Quantity		Carton Weight		Carton Cube		Pallet Qty.	List Price Each
			Box	Carton	Lbs.	Kilos	Ft.	M.		
A-JRDC-1	1 or 4 Station DC battery operated, 2 Independent programs, 2 Start Times, Water budget 10-200%	1	1	12	16.00	7.30	2.06	0.058	-	118.00
A-JRDC-4		4	1	12	32.00	14.60	1.939	0.055	-	145.00

Note: Junior DC controllers are used with A-DCL solenoids. See Controller Accessories.

Controllers Accessories

CMR - Commercial Maintenance Remote Control (Category Parts)

Part Number	Description	Quantity Carton	Carton Weight		Carton Cube		Pallet Qty.	List Price Each
			Lbs.	Kilos	Ft.	M.		
A-CMR-KIT	Kit, Maintenance Remote	5	4.41	2.00	-	-	-	790.00
A-CMR-TX	Assembly, Transmitter, Handheld,	10	1.25	0.57	-	-	-	520.00
A-CMR-RX	Assembly, Receiver, Handheld	10	1.00	0.45	-	-	-	394.00
A-CMR-CC	Assembly, Circular Connector	25	0.20	0.10	-	-	-	17.85
A-CMR-ANT	Antenna	25	0.20	0.10	-	-	-	24.15
A-CMR-CHG	Charger	25	0.20	0.10	-	-	-	24.15

Note: The A-CMR-KIT is a portable remote control. It is designed as a 1-person maintenance kit. It is designed to operate in concert with the MC-E, Total Control, Rain Dial, and Kwik Dial controllers.

Controller Accessories (Category VIII)

Part Number	Description	Quantity Carton	Carton Weight		Carton Cube		Pallet Qty.	List Price Each
			Lbs.	Kilos	Ft.	M.		
A-P-2B	Pedestal for 4-12 station MC E or all IBOC Plus controllers	1	12.00	5.00	0.70	0.020	48	482.00

Controller Accessories (Category Controller Parts)

Part Number	Description	Quantity Carton	Carton Weight		Carton Cube		Pallet Qty.	List Price Each
			Lbs.	Kilos	Ft.	M.		
SR-1	Pump start relay							95.50
A-DCL	Solenoid DC Latching (used with IBOC controllers & Junior DC controllers)	12	3.24	1.47	0.80	0.002	-	35.30

A black and white photograph of a dense cornfield. The corn plants are tall and have many long, pointed leaves. The field is filled with rows of these plants, extending towards the horizon. The sky is overcast and grey. The word "Filtration" is written in a large, bold, white sans-serif font across the middle of the image, centered horizontally and slightly above the vertical center.

Filtration

Filtration



Fiberglass Sand Media Filters - Automatic Systems (Category IX)

Part Number	Description	Solenoid Type	Tank Size In.	Flow Rate GPM	Connection Size	Quantity Carton	Carton Weight Lbs.	Carton Weight Kilos	Carton Cube Ft.	Carton Cube M.	List Price Each
-------------	-------------	---------------	---------------	---------------	-----------------	-----------------	--------------------	---------------------	-----------------	----------------	-----------------

Aqua-Clear Fiberglass Sand Media Filters: TWO-TANK AUTOMATIC SYSTEMS*

INCLUDED: Filter Body, Backwash valves, Air Vent, Controller, and Hydraulic Kit. 30" & 36" filters also includes 3" Fitting Kit.

ACS-218-12VDCL	2 x 18" Aqua Clear automated filter station	DCL	18	75	2"	—	—	—	—	—	4,435.00
ACS-218-24VAC		AC									4,507.00
ACS-224-12VDCL	2 x 24" Aqua Clear automated filter station	DCL	24	120	2"	—	—	—	—	—	5,280.00
ACS-224-24VAC		AC									5,352.00
ACS-230-12VDCL	2 x 30" Aqua Clear automated filter station	DCL	30	150	2"	—	—	—	—	—	7,432.00
ACS-230-24VAC		AC									7,504.00
ACS-236-12VDCL	2 x 36" Aqua Clear automated filter station	DCL	36	160	2"	—	—	—	—	—	9,173.00
ACS-236-24VAC		AC									9,245.00

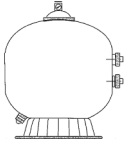

Aqua-Clear Fiberglass Sand Media Filters: ONE-TANK EXPANSION FOR AUTOMATIC SYSTEMS

INCLUDED: Filter Body, Bulkhead adapters, Backwash valves, Air Vent, Hydraulic tube & Fittings sufficient to add one filter to an existing Aqua-Clear system of the same filter size.

ACX-118-12VDCL	1 x 18" Aqua Clear automated filter station	DCL	18	See Sizing Recommendations Chart	2"	—	—	—	—	—	1,686.00
ACX-118-24VAC		AC									1,686.00
ACX-124-12VDCL	1 x 24" Aqua Clear automated filter station	DCL	24	See Sizing Recommendations Chart	2"	—	—	—	—	—	2,108.00
ACX-124-24VAC		AC									2,108.00
ACX-130-12VDCL	1 x 30" Aqua Clear automated filter station	DCL	30	See Sizing Recommendations Chart	2"	—	—	—	—	—	2,976.00
ACX-130-24VAC		AC									2,976.00
ACX-136-12VDCL	1 x 36" Aqua Clear automated filter station	DCL	36	See Sizing Recommendations Chart	2"	—	—	—	—	—	3,847.00
ACX-136-24VAC		AC									3,847.00

Sizing Recommendations:

Flow (gpm)	50	75	100	125	150	175	200	225	250	275	300	325	375	400
Filter Quantity x Tank Size	2 x 18"		2 x 24"	3 x 24"			3 x 30"			3 x 36"				

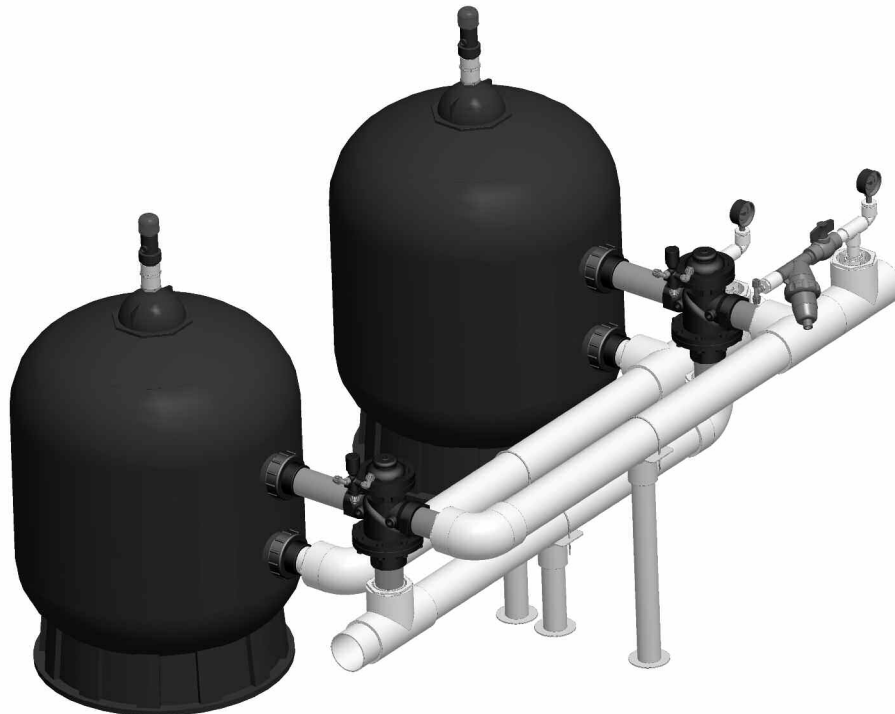

Filtration

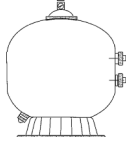

Fiberglass Sand Media Filters - Single Filters & Components (Category IX)

Part Number	Description	Solenoid Type	Fits Filter Sizes	Flow Rate GPH	Quantity Carton	Carton Weight		Carton Cube		List Price Each
						Lbs.	Kilos	Ft.	M.	
Aqua-Clear Fiberglass Sand Media Filters: SINGLE FILTER TANKS										
AC-40	18" Sand Media Filter (40 GAL)	—	18	38	1	26	11.8	6.9	0.20	881.00
AC-60	24" Sand Media Filter (60 GAL)	—	24	63	1	42	19.1	11.6	0.33	1,240.00
AC-100	30" Sand Media Filter (100 GAL)	—	30	74	1	66	29.9	22.5	0.64	1,810.00
AC-140	36" Sand Media Filter (140 GAL)	—	36	106	1	76	34.5	38.9	1.10	2,550.00
Automatic Backwash Controllers & Valves for Aqua-Clear Filters										
B-EXFP111002DP	Backwash Controller - 12v DCL	DC	18; 24; 30; 36	—	1	4	1.8	0.4	0.01	882.00
B-EXFP211002DP	Backwash Controller - 24v AC	AC	18; 24; 30; 36	—	1	4	1.8	0.4	0.01	943.00
B-S-TG-0208	Backwash Controller	DC	18; 24; 30; 36	—	1	0.01	0.004	—	—	51.00
	Expansion board 12v DCL									
B-S-TG-0215	Backwash Controller	AC	18; 24; 30; 36	—	1	0.01	0.004	—	—	51.00
	Expansion board 24v AC									
B2x2350S551DSPBZVI	2" Electric Backwash Valve (12v DCL)	DC	18; 24	—	1	7.9	3.6	1.0	0.03	394.00
B2x2350S554RCPBZVI	2" Electric Backwash Valve (24v AC)	AC	18; 24	—	1	7.9	3.6	1.0	0.03	394.00
B3x3350S551DSPBZVI	3" Electric Backwash Valve (12v DCL)	DC	30; 36	—	1	13.5	6.1	0.8	0.02	562.00
B3x3350S554RCPBZVI	3" Electric Backwash Valve (24v AC)	AC	30; 36	—	1	13.5	6.1	0.8	0.02	562.00
Hydraulic Kit Components for Aqua-Clear Filters*										
ACK-HYD1	Aqua-Clear Hydraulic Kit (Complete)	—	18; 24; 30; 36	—	1	5.5	2.5	0.6	0.02	317.93
GPM0100	Pressure gauge (0-100 psi)	—	—	—	96	—	—	—	—	47.10
B-8MMHYD-10	Hydraulic control tubing (8mm) (10 FT)	—	—	—	1	0.3	0.1	0.2	0.00	15.00
AC-BHA2	Bulkhead Adapters (2")	—	—	—	1	1.1	0.5	0.2	0.01	84.50
ALFD75150-L	3/4" disc filter	—	—	—	20	32	14.5	2.7	0.08	23.90
ARV-BBK1	Air release valve	—	—	—	25	5	2.3	—	—	9.38
28-102	Reducing Bushing 1/4" x 1/8", Brass	—	—	—	1	—	—	—	—	2.20
B-FT98-1T	Tee, Plastic [8mm Compression X 1/8" NPT]	—	—	—	1	—	—	—	—	3.78
B-FT28-EL	Elbow, Plastic [8mm Compression X 1/8" NPT]	—	—	—	1	—	—	—	—	2.90
B-FT98-T	Tee, Plastic [8mm Compression]	—	—	—	1	—	—	—	—	3.78
*Included with the Automatic Filter station. Part numbers are provided here for parts reference.										
3" Fitting Kit Components for Aqua-Clear Filters**										
ACK-3F	3" Fitting Kit (Complete)	—	30; 36	—	1	6.7	3.0	0.3	0.01	353.28
B-DS-V2030	Grooved Couplings (3")	—	—	—	1	3.5	1.6	—	—	44.00
VG03PE	Grooved Nipples	—	—	—	48	31	14.1	—	—	9.51
T-60403	Air Vent Cover Adapter	—	—	—	1	0.2	0.1	—	—	12.00
**Included with the Automatic Filter station. Part numbers are provided here for parts reference.										
Manual Filter Valves for Manual Operation of Aqua-Clear Filters										
AC-DV3P	2" PVC 3-Way Diverter Valve	—	—	2" spigot or 2½" slip	12	24	10.9	—	—	82.50
AC-STSV	Single Tank Backflush Valve (slide type)	—	—	2" slip	1	4.5	2.0	0.6	0.02	211.00



Filtration

Manual Disc Filters - NPT Thread (Category IX)

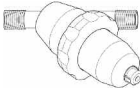
Part Number	Description	Flow Rate Max. gpm	Mesh note (*)	Connection Size (In.)	Quantity Carton	Carton Weight		Carton Cube		List Price Each
						Lbs.	Kilos	Ft.	M.	
F-Series Plastic Y Filters										
 ALFD75150-L	Manual Disc Plastic Y Filters (Large Body)	25	150	3/4" MPT	20	32.00	14.50	2.72	0.077	23.90
ALFD10150-L		35	150	1" MPT	20	32.00	14.50	2.72	0.077	28.40
ALFD15150-L		80	150	1-1/2" MPT	20	32.00	14.50	2.72	0.077	39.50
SD Standard Disc Series Plastic Disc Filters 2" NPT Thread (Short Body)										
IT-ABF5012-3SN	2" SD-Standard Disc Manual Plastic Filters with Short Body & Male NPT Thread	110	120 Mesh (Blue)	2"	1	20.00	9.10	1.80	0.051	224.00
IT-ABF5015-3SN		110	150 Mesh (Red)	2"	1	20.00	9.10	1.80	0.051	224.00
SD Standard Disc Series Plastic Disc Filters 3" NPT Thread (Short Body)										
IT-ABF7512-3SSN	3" SD-Standard Disc Manual Plastic Filters with Short Body & Male NPT Thread	170	120 Mesh (Blue)	3"	1	22.00	10.00	1.80	0.051	275.00
IT-ABF7515-3SSN		170	150 Mesh (Red)	3"	1	22.00	10.00	1.80	0.051	275.00
SD Standard Disc Series Plastic Disc Filters 2" NPT Thread (Long Body)										
◇ IT-ABF5012-3SLN	2" SD-Standard Disc Manual Plastic Filters with Long Body & Male NPT Thread	110	120 Mesh (Blue)	2"	1	26.00	11.80	2.50	0.071	300.00
◇ IT-ABF5015-3SLN		110	150 Mesh (Red)	2"	1	26.00	11.80	2.50	0.071	300.00
SD Standard Disc Series Plastic Disc Filters 3" NPT Thread (Long Body)										
IT-ABF7512-3SN	3" SD-Standard Disc Manual Plastic Filters with Long Body & Male NPT Thread	220	120 Mesh (Blue)	3"	1	28.00	12.70	2.50	0.071	310.00
IT-ABF7515-3SN		220	150 Mesh (Red)	3"	1	28.00	12.70	2.50	0.071	310.00

* SD Filters use standard grooved disc technology.

Ordering Information:

◇ = MADE TO ORDER. Minimum order quantity will apply. Please consult Toro Micro-Irrigation Customer Service for availability.

SD Filter Replacement Elements (Category IX)

Part Number	Description	Mesh Size	Quantity		Carton Weight		Carton Cube		List Price Each
			Each	Carton	Lbs.	Kilos	Ft.	M.	
 IT-AMPS204-120	2" SD CARTRIDGE 120 MESH w/ O-Ring (Blue)	120	1	6	60.00	27.20	57.00	2.40	110.00
IT-AMPS204-150	2" SD CARTRIDGE 150 MESH w/ O-Ring (Red)	150	1	6	60.00	27.20	57.00	2.40	110.00
IT-AMPS304-120	3" SD CARTRIDGE 120 MESH w/ O-Ring (Blue)	120	1	4	60.00	27.20	57.00	2.40	154.00
IT-AMPS304-150	3" SD CARTRIDGE 150 MESH w/ O-Ring (Red)	150	1	4	60.00	27.20	57.00	2.40	154.00

SD Disc Rings

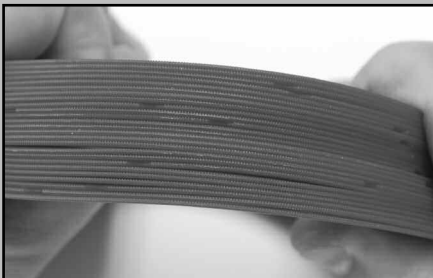

Disc Characteristics:

- Narrowing, cross-hatched grooves trap particles and debris between and on the outside of the disc rings:
 - Each side of the standard disc ring has opposite running tapered grooves, thereby creating an interweaving labyrinth among the discs.
- The standard disc rings press together and utilize the cross-hatched groove design, allowing only clean water to flow through.
- Available in 120 and 150 mesh.

Filtration

XD Manual Disc Filters - NPT Thread (Category IX)*

Part Number	Description	Flow Rate	Mesh	Connection	Quantity	Carton Weight		Carton Cube		List Price
		Max. gpm	note (*)	Size (In.)		Lbs.	Kilos	Ft.	M.	

XD Series Plastic Disc Filters 2" NPT Thread (Short Body)

◇ IT-ABF5050-3X-N	2" XD Series Manual Plastic Disc Filters with Short Body & Male NPT Thread	110	50 (Yellow)	2"	1	20.00	9.10	1.80	0.051	247.00
◇ IT-ABF5085-3X-N		110	85 (Gray)	2"	1	20.00	9.10	1.80	0.051	247.00
◇ IT-ABF5012-3X-N		110	120 (Blue)	2"	1	20.00	9.10	1.80	0.051	247.00
◇ IT-ABF5015-3X-N		110	150 (Red)	2"	1	20.00	9.10	1.80	0.051	247.00
◇ IT-ABF5020-3X-N		110	200 (Brown)	2"	1	20.00	9.10	1.80	0.051	247.00

XD Series Plastic Disc Filters 3" NPT Thread (Short Body)

◇ IT-ABF7550-3XSN	3" XD Series Manual Plastic Disc Filters with Short Body & Male NPT Thread	170	50 (Yellow)	3"	1	22.00	10.00	1.80	0.051	289.00
◇ IT-ABF7585-3XSN		170	85 (Gray)	3"	1	22.00	10.00	1.80	0.051	289.00
◇ IT-ABF7512-3XSN		170	120 (Blue)	3"	1	22.00	10.00	1.80	0.051	289.00
◇ IT-ABF7515-3XSN		170	150 (Red)	3"	1	22.00	10.00	1.80	0.051	289.00
◇ IT-ABF7520-3XSN		170	200 (Brown)	3"	1	22.00	10.00	1.80	0.051	289.00

XD Series Plastic Disc Filters 3" NPT Thread (Long Body)

◇ IT-ABF7550-3X-N	3" XD Series Manual Plastic Disc Filters with Long Body & Male NPT Thread	220	50 (Yellow)	3"	1	28.00	12.70	2.50	0.071	351.00
◇ IT-ABF7585-3X-N		220	85 (Gray)	3"	1	28.00	12.70	2.50	0.071	351.00
◇ IT-ABF7512-3X-N		220	120 (Blue)	3"	1	28.00	12.70	2.50	0.071	351.00
◇ IT-ABF7515-3X-N		220	150 (Red)	3"	1	28.00	12.70	2.50	0.071	351.00
◇ IT-ABF7520-3X-N		220	200 (Brown)	3"	1	28.00	12.70	2.50	0.071	351.00

XD Manual Disc Filters - BSP Thread (Category IX)*

Part Number	Description	Flow Rate	Mesh	Connection	Quantity	Carton Weight		Carton Cube		List Price
		Max. gpm	note (*)	Size (In.)		Lbs.	Kilos	Ft.	M.	

XD Series Plastic Disc Filters 2" BSP Thread (Short Body)

◇ IT-ABF5050-3X	2" XD Series Manual Plastic Disc Filters with Short Body & Male BSP Thread	110	50 (Yellow)	2" BSP	1	20.00	9.10	1.80	0.051	247.00
◇ IT-ABF5085-3X		110	85 (Gray)	2" BSP	1	20.00	9.10	1.80	0.051	247.00
◇ IT-ABF5012-3X		110	120 (Blue)	2" BSP	1	20.00	9.10	1.80	0.051	247.00
◇ IT-ABF5015-3X		110	150 (Red)	2" BSP	1	20.00	9.10	1.80	0.051	247.00
◇ IT-ABF5020-3X		110	200 (Brown)	2" BSP	1	20.00	9.10	1.80	0.051	247.00

XD Series Plastic Disc Filters 3" BSP Thread (Long Body)

◇ IT-ABF7550-3X	3" XD Series Manual Plastic Disc Filters with Long Body & Male BSP Thread	220	50 (Yellow)	3" BSP	1	28.00	12.70	2.50	0.071	351.00
◇ IT-ABF7585-3X		220	85 (Gray)	3" BSP	1	28.00	12.70	2.50	0.071	351.00
◇ IT-ABF7512-3X		220	120 (Blue)	3" BSP	1	28.00	12.70	2.50	0.071	351.00
◇ IT-ABF7515-3X		220	150 (Red)	3" BSP	1	28.00	12.70	2.50	0.071	351.00
◇ IT-ABF7520-3X		220	200 (Brown)	3" BSP	1	28.00	12.70	2.50	0.071	351.00

Ordering Information:

◇ = MADE TO ORDER. Please consult Toro Micro-Irrigation Customer Service for Availability

XD Disc Rings

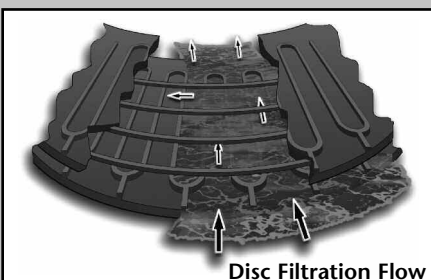

Disc Characteristics:

- The specially designed two-sided disc ring features:
 - On one side, a sinusoidal (~~~~) disc pattern
 - And on the other side, grooves in concentric (⊙) circles
- Both sides working together gives a surface area that is unachievable by any other standard disc ring. This results in longer periods between cleanings, less filter maintenance and prolonged product life.
- Available in 50, 85, 120, 150, and 200 mesh.



Filtration

XD Filter Replacement Elements (Category IX)



Part Number	Description	Mesh Size	Quantity Carton	Carton Weight		Carton Cube		List Price Each
				Lbs.	Kilos	Ft.	M.	
XD Series Plastic Disc Filters								
IT-AMPX0204-050	2" XD Filter Disc Cartridge w/ O-Ring (Yellow)	50	1	10.00	4.50	14.13	0.400	119.00
IT-AMPX0204-085	2" XD Filter Disc Cartridge w/ O Ring (Gray)	85	1	10.00	4.50	14.13	0.400	119.00
IT-AMPX0204-120	2" XD Filter Disc Cartridge w/ O-Ring (Blue)	120	1	10.00	4.50	14.13	0.400	119.00
IT-AMPX0204-150	2" XD Filter Disc Cartridge w/ O-Ring (Red)	150	1	10.00	4.50	14.13	0.400	119.00
IT-AMPX0204-200	2" XD Filter Disc Cartridge w/ O-Ring (Brown)	200	1	10.00	4.50	14.13	0.400	119.00
IT-AMPX0304-050	3" XD Filter Disc Cartridge w/ O-Ring (Yellow)	50	1	15.00	6.80	14.13	0.400	200.00
IT-AMPX0304-085	3" XD Filter Disc Cartridge w/ O-Ring (Gray)	85	1	15.00	6.80	14.13	0.400	200.00
IT-AMPX0304-120	3" XD Filter Disc Cartridge w/ O-Ring (Blue)	120	1	15.00	6.80	14.13	0.400	200.00
IT-AMPX0304-150	3" XD Filter Disc Cartridge w/ O-Ring (Red)	150	1	15.00	6.80	14.13	0.400	200.00
IT-AMPX0304-200	3" XD Filter Disc Cartridge w/ O-Ring (Brown)	200	1	15.00	6.80	14.13	0.400	200.00

Manual Screen Filters (Category IX)

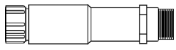

Part Number	Description	Flow Rate Max. gpm	Mesh note (")	Connection Size (in.)	Quantity Carton	Carton Weight		Carton Cube		List Price Each
						Lbs.	Kilos	Ft.	M.	
3/4" Plastic In-Line Hose Filters										
AH11000	In-Line Manual Plastic Screen-3/4" FHT inlet X 3/4" FHT outlet	—	200	3/4" FHT	200	51.00	23.00	1.35	0.038	16.00
AH12000		—	34	3/4" FHT	200	56.00	25.00	1.35	0.038	16.00
AHP2431	In-Line plastic body only, 3/4" FHT inlet X 3/4" FHT outlet	—	—	—	200	45.00	20.00	1.35	0.038	11.80

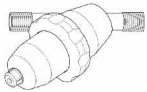

Part Number	Description	Flow Rate Max. gpm	Mesh note (")	Connection Size (in.)	Quantity Carton	Carton Weight		Carton Cube		List Price Each
						Lbs.	Kilos	Ft.	M.	
F-Series Plastic Y-Filters										
ALFS75150-S	Manual Screen Plastic Y Filters (Small Body)	18	150	3/4" MPT	60	32.00	14.50	2.72	0.077	12.40
ALFS10050-S		25	50	1" MPT	60	32.00	14.50	2.72	0.077	16.10
ALFS10150-S		25	150	1" MPT	60	32.00	14.50	2.72	0.077	16.10
ALFS75150-L	Manual Screen Plastic Y Filters (Large Body)	25	150	3/4" MPT	20	32.00	14.50	2.72	0.077	17.90
ALFS10050-L		35	50	1" MPT	20	32.00	14.50	2.72	0.077	19.80
ALFS10150-L		35	150	1" MPT	20	32.00	14.50	2.72	0.077	19.80
ALFS15150-L		80	150	1-1/2" MPT	20	32.00	14.5	2.72	0.077	24.70

Filter Replacement Elements (Category IX)

Part Number	Description	Mesh Size	Quantity Carton	Carton Weight		Carton Cube		List Price Each
				Lbs.	Kilos	Ft.	M.	
F-Series Plastic Y Filter Cartridges (Small Body)								
AMP0004-1S	Screen Cartridge for 3/4" & 1" Small Body Filter	150	1	—	—	—	—	7.23
AMP0004-2S-S	Screen Cartridge for 3/4" & 1" Small Body Filter	50	1	—	—	—	—	4.93
F-Series Plastic Y Filter Cartridges (Large Body)								
AMP0004-2F	Screen Cartridge for 3/4"; 1" & 1-1/2" Large Body Filter	150	1	—	—	—	—	9.25
AMP0004-4F	Disc Cartridge for 3/4"; 1" & 1-1/2" Large Body Filter	150	1	—	—	—	—	12.40

Ordering Information:

Fore replacement elements & parts, please refer to the Filter Replacement Parts.





**Promotional
Items &
Sales Policy
Information**

Literature

Product Literature (Category XI)

Part Number	Description	Quantity Pack	Pack Weight		Pack Cube		Net Price per Pack
			Lbs.	Kilos	Ft.	M.	
Product Catalog							
ALT001	Micro-Irrigation Product Catalog	1	—	—	—	—	15.00
Price List							
ALT002-1	Micro-Irrigation Price List for Agriculture	1	—	—	—	—	10.00
Drip Tape							
ALT046-1	Aqua-Traxx® Sell Sheet	25	—	—	—	—	50.00
ALT230	Aqua-Traxx® & Aqua-Traxx® FC Family Brochure	25	—	—	—	—	50.00
ALT049-1	Aqua-Traxx® Performance Charts Brochure	1	—	—	—	—	15.00
ALT073	Aqua-Traxx® Design Manual	1	—	—	—	—	10.00
ALT003	Aqua-Traxx® 8 1/2 x 11 Tri-fold brochure with samples of the sizes and wall thickness for the Aqua-Traxx product line	1	—	—	—	—	15.00
Thinwall Dripline							
ALT203	Thinwall Dripline Sell Sheet	25	—	—	—	—	50.00
Dripline							
ALT107	BlueLine™ Classic Inline Dripline Brochure	25	—	—	—	—	50.00
ALT106	BlueLine™ PC Inline Dripline Brochure	25	—	—	—	—	50.00
DLT001	Drip In® Classic Inline Dripline Brochure	25	—	—	—	—	50.00
DLT002-1	Drip In® PC Inline Dripline Brochure	25	—	—	—	—	50.00
ALT070-1	ROOTGUARD® Brochure	25	—	—	—	—	50.00
ALT023	Subsurface Irrigation Design Manual	25	—	—	—	—	50.00
Hose							
ALT022-1	Oval Hose Sell Sheet	25	—	—	—	—	50.00
ALT007-1	Round Hose Sell Sheet	25	—	—	—	—	50.00
ALT156	Layflat Hose Sell Sheet	25	—	—	—	—	50.00
ALT184	IPS Flex PVC Tubing Sell Sheet	25	—	—	—	—	50.00
On-Line Emitters							
ALT026-1	NGE® AL (New Generation Emitter Anti Drain) Sell Sheet	25	—	—	—	—	50.00
ALT027-1	NGE® SF (New Generation Emitter Self Flushing) Sell Sheet	25	—	—	—	—	50.00
ALT014-1	Turbo SC™ / Turbo Key™ Sell Sheet	25	—	—	—	—	50.00
ALT016-1	E-2® Emitter Sell Sheet	25	—	—	—	—	50.00
ALT085-1	Black Spider Sell Sheet	25	—	—	—	—	50.00
Fogger's, Snap-Jets & Micro-Sprinklers							
ALT018	Fogger Sell Sheet	25	—	—	—	—	50.00
ALT020	Snap-Jet®II Sell Sheet	25	—	—	—	—	50.00
ALT065-1	Micro-Sprinkler VI Classic Sell Sheet	25	—	—	—	—	50.00
ALT006-1	Micro-Sprinkler VI PC Sell Sheet	25	—	—	—	—	50.00
ALT209	Micro Sprinkler PC Sell Sheet	25	—	—	—	—	50.00
ALT025	Fogger, Snap Jet & Micro Sprinkler Accessories Sell Sheet	25	—	—	—	—	50.00
ALT031	Pot Spray Stake Sell Sheet	25	—	—	—	—	50.00
Valves							
ALT011	100 Series Valves Sell Sheet	25	—	—	—	—	50.00
ALT057-1	600 Series (3-way pilot) Valves Sell Sheet	25	—	—	—	—	50.00
ALT012-1	700 Series Valves Sell Sheet	25	—	—	—	—	50.00
ALT013-1	4" Sentinel™ Valve Sell Sheet	25	—	—	—	—	50.00
ALT087	Air Release Valve Brochure	25	—	—	—	—	50.00
ALT146	Bermad Valves Booklet	25	—	—	—	—	50.00
ALT148	PVC Valves Sell Sheet	25	—	—	—	—	50.00
Controllers							
ALT009	Rain Dial® Controller Sell Sheet	25	—	—	—	—	50.00
ALT058	MC-E® Series Controller Sell Sheet	25	—	—	—	—	50.00
ALT008-1	IBOC® Plus Controller Sell Sheet	25	—	—	—	—	50.00
ALT136	KwikDial® Series Controller Sell Sheet	25	—	—	—	—	50.00
ALT167	Junior DC® Sell Sheet (English & Spanish)	25	—	—	—	—	50.00
ALT055	Total Control® Controller	25	—	—	—	—	50.00
Chemical Injection							
ALT032	Mazzei® Chemical Injection Brochure	25	—	—	—	—	50.00
Filtration							
ALT010	Plastic Y Filters Sell Sheet	25	—	—	—	—	50.00
ALT103	XD Filter Sell Sheet	25	—	—	—	—	50.00
ALT199	Aqua-Clear™ Fiberglass Sand Filters	25	—	—	—	—	50.00
ALT227	Aqua-Clear™ Automation Manual	1	—	—	—	—	10.00
Accessories							
ALT177	Pro-Loc Fittings Brochure	25	—	—	—	—	50.00
ALT202	Tools & Accessories	25	—	—	—	—	50.00
ALT052-1	Hose & Tape Fittings Sell Sheet	25	—	—	—	—	50.00
ALT158	Xpando® Take-Off Fittings Sell Sheet	25	—	—	—	—	50.00
ALT173	Oval and Layflat Connection Fittings Sell Sheet	25	—	—	—	—	50.00



Literature

Product Literature - Spanish (Category XI)

Part Number	Description	Quantity Pack	Pack Weight		Pack Cube		Net Price per Pack
			Lbs.	Kilos	Ft.	M.	
Product Catalog							
ALT207	Micro-Irrigation Product Catalog (Spanish)	1	—	—	—	—	15.00
Drip Tape							
ALT101	Aqua-Traxx® 8 1/2 x 11 Tri-fold brochure with samples of the sizes and wall thickness for the Aqua-Traxx product line (Sp)	1	—	—	—	—	15.00
ALT061-1	Aqua-Traxx® Sell Sheet (Sp)	25	—	—	—	—	50.00
ALT232	Aqua-Traxx® & Aqua-Traxx® FC Family Brochure (Spanish)	25	—	—	—	—	50.00
Thinwall Dripline							
ALT204	Thinwall Dripline Sell Sheet (Spanish)	25	—	—	—	—	50.00
Dripline							
ALT092	ROOTGUARD® Brochure (Sp)	25	—	—	—	—	50.00
ALT188	BlueLine™ Classic Inline Dripline Brochure	25	—	—	—	—	50.00
ALT212	BlueLine™ PC Dripline Brochure	25	—	—	—	—	50.00
ALT210	Drip-In Classic Sell Sheet	25	—	—	—	—	50.00
ALT211	Drip-In PC Sell Sheet	25	—	—	—	—	50.00
Hose							
ALT037	Blue Stripe® Round Hose Sell Sheet (Sp)	25	—	—	—	—	50.00
ALT064-1	Oval Hose Sell Sheet (Sp)	25	—	—	—	—	50.00
ALT164	Layflat Hose Sell Sheet (Sp)	25	—	—	—	—	50.00
ALT187	IPS Flex PVC Tubing Sell Sheet (Sp)	25	—	—	—	—	50.00
On-Line Emitters							
ALT015	Black Spider Sell Sheet (Sp)	25	—	—	—	—	50.00
ALT062-1	NGE® SF (New Generation Emitter) Sell Sheet (Sp)	25	—	—	—	—	50.00
ALT048	NGE® AL (New Generation Emitter) Sell Sheet (Sp)	25	—	—	—	—	50.00
Fogger's, Snap-Jets & Micro-Sprinklers							
ALT113	Fogger Sell Sheet (Sp)	25	—	—	—	—	50.00
ALT021	Micro-Sprinkler VI PC Sell Sheet (Sp)	25	—	—	—	—	50.00
ALT017	Micro-Sprinkler VI Classic Sell Sheet (Sp)	25	—	—	—	—	50.00
ALT041	Pot Spray Stake Sell Sheet (Sp)	25	—	—	—	—	50.00
ALT120	Fogger, Snap Jet & Micro Sprinkler Accessories Sell Sheet (Sp)	25	—	—	—	—	50.00
ALT220	E2 Sell Sheet (Spanish)	25	—	—	—	—	50.00
ALT221	Snap Jet Sell Sheet (Spanish)	25	—	—	—	—	50.00
Valves							
ALT117	100 Series Valves Sell Sheet (Spanish)	25	—	—	—	—	50.00
ALT034	600 Series Valve Sell Sheet (Spanish)	25	—	—	—	—	50.00
ALT029	Sentinel Valve Sell Sheet (Spanish)	25	—	—	—	—	50.00
ALT035	Air Release Valve Brochure (Spanish)	25	—	—	—	—	50.00
ALT151	PVC Valves Sell Sheet (Spanish)	25	—	—	—	—	50.00
ALT222	700 Series Valves Sell Sheet (Spanish)	25	—	—	—	—	50.00
ALT223	Bermad Valves Sell Sheet (Spanish)	25	—	—	—	—	50.00
Controllers							
ALT118	Total Control® Controller Sell Sheet (Spanish)	25	—	—	—	—	50.00
ALT167	Junior DC® Sell Sheet (English & Spanish)	25	—	—	—	—	50.00
ALT216	IBOC Sell Sheet (Spanish)	25	—	—	—	—	50.00
ALT217	Kwik Dial Sell Sheet (Spanish)	25	—	—	—	—	50.00
ALT218	MCE Sell Sheet (Spanish)	25	—	—	—	—	50.00
ALT219	Rain Dial Sell Sheet (Spanish)	25	—	—	—	—	50.00
Chemical Injection							
ALT036	Mazzei® Chemical Injection Brochure (Sp)	25	—	—	—	—	50.00
Filters							
ALT024	XD Filter Sell Sheet (Sp)	25	—	—	—	—	50.00
ALT039	Plastic Y Filter Sell Sheet (Sp)	25	—	—	—	—	50.00
ALT201	Aqua-Clear™ Fiberglass Sand Filters (Spanish)	25	—	—	—	—	50.00
Accessories							
ALT178	Pro-Loc Fittings Brochure (Sp)	25	—	—	—	—	50.00
ALT119	Hose & Tape Fittings Sell Sheet (Sp)	25	—	—	—	—	50.00
ALT170	Xpando® Take-Off Fittings Sell Sheet (Sp)	25	—	—	—	—	50.00
ALT176	Oval and Layflat Connection Fittings Sell Sheet (Sp)	25	—	—	—	—	50.00
ALT205	Tools & Accessories (Spanish)	25	—	—	—	—	50.00



Literature

Educational Literature (Category XI)							
Part Number	Description	Quantity Carton	Carton Weight		Carton Cubic		Net Price Each
			Lbs.	Kilos	Ft.	M.	
Education							
ALT179	Drip Irrigation Owner's Manual	1	—	—	—	—	15.00
ALT180	Quick Start Guide - Owner's Manual	1	—	—	—	—	10.00
ALT142	Irrigation Solutions - What is Drip Irrigation?	25	—	—	—	—	50.00
ALT143	Crop Solutions - Drip Irrigation on Corn	25	—	—	—	—	50.00
ALT144	Grower Solutions - Cox Valley View Farms Testimonial	25	—	—	—	—	50.00
ALT152	Grower Solutions - Weilmunster Farms Testimonial	25	—	—	—	—	50.00
ALT153	Grower Solutions - Standage Farms Testimonial	25	—	—	—	—	50.00
ALT154	Grower Solutions - Reiter Berry Farms Testimonial	25	—	—	—	—	50.00
ALT155	Irrigation Solutions - The Advantages of Closely Spaced Emitters	25	—	—	—	—	50.00
ALT159	Grower Solutions - Naumann Ranch Testimonial	25	—	—	—	—	50.00
ALT160	Grower Solutions - Craig Andrus Farms Testimonial	25	—	—	—	—	50.00
ALT161	Irrigation Solutions - Typical Drip System Layout	25	—	—	—	—	50.00
ALT182	Crop Solutions - Drip Irrigation on Potatoes	25	—	—	—	—	50.00
ALT183	Grower Solutions - Worth Farms Testimonial	25	—	—	—	—	50.00
ALT185	Crop Solutions - Drip Irrigation on Alfalfa	25	—	—	—	—	50.00
ALT186	Crop Solutions - Drip Irrigation on Cotton	25	—	—	—	—	50.00
ALT186	Crop Solutions - Drip Irrigation on Mint	25	—	—	—	—	50.00
ALT208	Irrigation Solutions - Subsurface Drip Irrigation for Field Crops	25	—	—	—	—	50.00
ALT228	Irrigation Solutions - Micro-Sprinklers for Integrated Pest Management (IPM)	25	—	—	—	—	50.00
Finance							
ALT165	Grower Finance Brochure	25	—	—	—	—	50.00
ALT166	Dealer Finance Brochure	25	—	—	—	—	50.00

Educational Literature - Spanish (Category XI)							
Part Number	Description	Quantity Carton	Carton Weight		Carton Cubic		Net Price Each
			Lbs.	Kilos	Ft.	M.	
Education							
ALT195	Drip Irrigation Owner's Manual (Spanish)	1	—	—	—	—	15.00
ALT181	Quick Start Guide - Owner's Manual (Spanish)	1	—	—	—	—	10.00
ALT150	Irrigation Solutions - What is Drip Irrigation? (Spanish)	25	—	—	—	—	50.00
ALT157	Crop Solutions - Drip Irrigation on Corn (Spanish)	25	—	—	—	—	50.00
ALT171	Grower Solutions - Cox Valley View Farms Testimonial (Spanish)	25	—	—	—	—	50.00
ALT189	Grower Solutions - Standage Farms Testimonial (Spanish)	25	—	—	—	—	50.00
ALT190	Grower Solutions - Weilmunster Farms Testimonial (Spanish)	25	—	—	—	—	50.00
ALT191	Grower Solutions - Reiter Berry Farms Testimonial (Spanish)	25	—	—	—	—	50.00
ALT192	Irrigation Solutions - The Advantages of Closely Spaced Emitters (Spanish)	25	—	—	—	—	50.00
ALT193	Grower Solutions - Craig Andrus Farms Testimonial (Spanish)	25	—	—	—	—	50.00
ALT194	Grower Solutions - Naumann Ranch Testimonial (Spanish)	25	—	—	—	—	50.00
ALT196	Crop Solutions - Drip Irrigation on Alfalfa (Spanish)	25	—	—	—	—	50.00
ALT197	Crop Solutions - Drip Irrigation on Potatoes (Spanish)	25	—	—	—	—	50.00
ALT198	Crop Solutions - Drip Irrigation on Cotton (Spanish)	25	—	—	—	—	50.00
ALT214	Crop Solutions - Drip Irrigation on Mint (Spanish)	25	—	—	—	—	50.00
ALT215	Irrigation Solutions - Subsurface Drip Irrigation (Spanish)	25	—	—	—	—	50.00
ALT224	Grower Solutions - Worth Farms Testimonial (Spanish)	25	—	—	—	—	50.00
ALT231	Irrigation Solutions - Micro-Sprinklers for Integrated Pest Management (IPM)	25	—	—	—	—	50.00
Finance							
ALT168	Grower Finance Brochure (Spanish)	25	—	—	—	—	50.00
ALT169	Dealer Finance Brochure (Spanish)	25	—	—	—	—	50.00

Promotional Items

Promotional Items (Category XI)							
Part Number	Description	Quantity Carton	Carton Weight		Carton Cubic		Net Price Each
			Lbs.	Kilos	Ft.	M.	
Giveaways							
ALT229	Aqua-Traxx Notepads	1	—	—	—	—	2.00
Posters							
ALT174	Typical Drip System Layout Poster	1	—	—	—	—	25.00
ALT175	Typical Drip System Layout Poster (Sp)	1	—	—	—	—	25.00
Banners							
ALT047	Aqua-Traxx Banner	1	—	—	—	—	25.00
Product Displays							
ALT145	Display Aqua-Traxx Reels. Lightweight reels for easy handling at events. Specify PC or Classic.	1	5.00	2.27	2.80	—	35.00

Toro Micro-Irrigation literature is also available on our Print-on-Demand website at:
<https://custompoint.rrd.com/xs2/prelogin?CMPID=4284&&qwerty=14102202>

Additional promotional items are available from The Toro Company e-Store at:
<http://store.4imprint.com/toro>



Terms and Conditions

Toro Micro-Irrigation for Agriculture Terms and Conditions of Sale – USA

In addition to the Terms and Conditions set forth in any P.O. Acknowledgement issued by Toro Micro-Irrigation or otherwise brought to the dealer's attention, the following terms and conditions shall apply to any purchase of Toro Micro-Irrigation products:

Terms: Payment is due net thirty (30) days from date of invoice, upon credit approval, at the following address:

Toro Micro-Irrigation, 36346 Treasury Center, Chicago, IL, 60694-6300 USA

Minimum Order: US \$250.00 net per shipping location. This minimum applies to whole goods. There is no minimum order value for replacement parts.

Overrun Policy: For products that fall under the made to order classification, up to five (5) additional reels will be added to the ordered quantity. If the quantity of reels produced is greater than the ordered quantity, the purchase order and the final invoice will be modified to match the produced quantity.

Late Charge: Overdue accounts shall bear interest at the rate of 1.5% per month or the maximum rate allowed by law.

Pricing: All list prices are US\$, FOB shipping point and subject to change without notice. Order confirmations will be sent upon acceptance of purchase order, confirming terms and conditions of sale in addition to those set forth herein.

Freight Policy Domestic Dealers: Freight is FCA Toro Distribution Center. Shipping policy is with a Toro Micro-Irrigation selected carrier. Shipments are made to physical dealer location. Shipments or drop shipments outside dealer location are only allowed within a 100 mile radius of dealer location. Shipped prepaid and added to the customer invoice, unless one of the following exceptions applies:

•**Mixed goods** - Combination of goods other than hose, dripline, tape, and flat emitter dripline with a minimum value of US\$ 4,000.00 net. Freight will be prepaid by Toro Micro-Irrigation. Freight Carrier Surcharges are not paid by Toro Micro-Irrigation and are the responsibility of the dealer.

•**Tape or Flat Emitter Dripline Truckload** – Minimum shipment of 30 pallets (480 reels) or more. Freight will be prepaid by Toro Micro-Irrigation.

•**Tape or Flat Emitter Dripline LTL** – Minimum shipment of four (4) pallets or more. Maximum freight allowance of 5% of invoice amount, not to exceed the total freight charge, will be prepaid by Toro Micro-Irrigation.

◦**Tape or Flat Emitter Dripline & Oval Hose or Layflat** – For every four (4) pallets of Tape or Flat Emitter Dripline ordered, 1 (one) pallet of Oval Hose or Layflat can be shipped under either of the above tape or Flat Emitter Dripline (Truckload or LTL) freight policies. The number of pallets of Oval Hose or Layflat cannot exceed 25% of the pallets of Tape or Flat Emitter Dripline.

•**Layflat** – Orders with a minimum value of \$3,000 will have freight prepaid by Toro Micro-Irrigation.

•**IPS** – Orders with a minimum value of \$3,000 will have freight prepaid by Toro Micro-Irrigation.

•**Full Truckload** - A maximum freight allowance of 4% of invoice amount, not to exceed the total freight charge, will be paid on full truckloads of:

- Hose
- Dripline
- Any combination of goods (hose, dripline, tape, flat emitter dripline, molded goods)

Freight allowance will be given on invoice. Freight Allowance does not apply to will call orders.

For palletized Round Hose and Dripline, Net **US\$ 8.00** per pallet service charge will apply for **seven (7)** pallets and above. Please refer to price list for full truckload shipping quantities. No pallet surcharges will apply for products that are normally packaged on pallets such as Aqua-Traxx, Flat Emitter Dripline, Oval Hose & Micro-Distribution Hose and stated as *Palletized*.

Multiple drop shipments to dealer locations are billed at actual cost plus US\$ 100.00 service charge. Please call Customer Service for a freight quotation.

Freight Policy International Dealers: Shipment destinations are to the domestic freight forwarder chosen by the dealer. Freight is FCA Toro Distribution Center. The above policy for freight applies to the domestic component of freight. For International Shipments a US\$ 10.00 per pallet service charge will apply for treated pallets. Drop shipments are not allowed for international shipments.

Return Goods:

Warranty: The dealer will provide a copy of Toro's written product warranty and any installation instructions or similar product information to its customers at or before the time of sale. In the event of a warranty claim, Toro Micro-Irrigation must be notified in writing within the applicable warranty period and within 30 days after discovering the product is not functioning properly. Toro will review the situation with the dealer and provide an answer within a reasonable time.

Non-Warranty: All returned merchandise requires a Return Goods Authorization (RGA) to insure proper tracking. All made to order, discontinued or special order items are not returnable.

To receive an RGA number the dealer should contact:

Toro Micro-Irrigation Customer Service Department

El Cajon, Ca Customer Service:

Phone: +1 (800) 333-8125 or +1 (619) 562-2950,
Fax: +1 (800) 892-1822 or +1 (619) 596-4247 or
+1 (619) 258-9973

Sanford, Fl Customer Service:

Phone: +1 (800) 806-6582
Fax: +1 (800) 314-5328

The material must be returned within 60 days from date of invoice, in the original factory sealed packaging, in saleable condition, full carton quantities and freight prepaid. A 25% restocking charge will apply to items being returned unless the goods are being returned due to an order entry or shipping error. A credit to the dealers account will be issued providing the goods are not made to order, discontinued items, shopworn or are a special order.

Claims for Shortages: All claims for shortage or damage must be submitted in writing to the freight carrier directly and to Toro Micro-Irrigation Customer Service within 5 days of receipt of goods. A legible copy of the bill of lading must also be included to verify receipt of product. Toro Micro-Irrigation is not liable for damage or loss occurring during shipment. Acceptance of

shipped product by dealer or dealer agent is the responsibility of the dealer including proper count of product(s) and inspection of the product.

Delivery: Delivery estimates are made in good faith and are subject to delay due to government restrictions, failure of our suppliers to deliver, fires, strikes or other causes beyond our control. Any equipment needed for unloading is the responsibility of the consignee. It is not the responsibility of the driver to assist in the unloading process.

Additional Conditions of Sale: The laws of the State of California apply to all Toro Micro-Irrigation contracts and commercial dealings. State Laws vary widely on the subject of commercial Credit interest and late charges. The Federal Usury Pre-Exemption Law currently in effect will apply to all transactions wherever applicable. The dealer will not (i) violate any laws prohibiting corrupt business practices; (ii) take any action that will cause Toro Micro-Irrigation or its affiliates to violate any laws, including the U.S. Foreign Corrupt Practices Act of 1977 as amended; (iii) export, re-export, resell, release, or otherwise transfer, in violation of U.S. law, any Toro Micro-Irrigation supplied item to any country subject to comprehensive U.S. trade sanctions or partial U.S. trade sanctions; (iv) participate in any illegal customer restrictions or boycotts prohibited under local law or the laws of the U.S.; (v) misuse, register or assert ownership over any Toro trademarks or Toro domain names (i.e. domain names including any Toro names or marks); or (vi) incite, enable, or knowingly allow third parties to commit acts mentioned under subparagraphs (i) – (v), above.

Toro Micro-Irrigation Terms and Conditions of Sale – International

Terms:

1)**Direct Bank Transfer In Advance** - Wire transfers in U.S. Dollars to US Bank 800 Nicollet Mall, Minneapolis, MN 55402; ABA# 091000022 Swift# USBKUS44 IMT For: Toro Micro-Irrigation, Account# 1-502-5003-8489 with instruction to advise full details by telephone. Please reference dealer name as the remitter.

Or

2)**Confirmed Irrevocable Letter Of Credit** - Letter of credit must be confirmed by a USA bank. Do not use a USA subsidiary of a foreign bank. Letters of credit must be valid for a minimum of 90 days, from date of issue. All bank charges are to be paid by buyer. To ensure the most rapid shipment of your order, please send full text of letter of credit to the U.S. correspondent bank by tested telex.

Minimum Order:

- 1)Via Direct Bank Transfer In Advance - US\$ 500.00 net.
- 2)Via Letter of Credit – US\$10,000.00 net.

Freight Policy International: The above policy for Freight USA applies. Shipment destinations are FAS Florida Port or California Port or DAF "Delivered at USA Frontier". For International shipments requiring treated pallets, a **US\$ 10.00** per pallet service charge will apply.

All other terms and conditions set forth in any P.O. Acknowledgement issued by Toro or otherwise brought to the buyer's attention shall apply.



Micro-Irrigation Business

Sales Warranty

Toro Micro-Irrigation and its affiliate, Toro Warranty Company pursuant to an agreement between them, jointly warrant to Toro Micro-Irrigation trade customers that Toro Micro-Irrigation products for agricultural use will be free from original defects in materials and workmanship.

Toro Micro-Irrigation Price list is F.O.B. Factory. Neither Toro Micro-Irrigation nor Toro Warranty Company is liable for loss or damage occurring during shipment. Responsibility for safe delivery is assumed by the customer and freight carrier at the time of shipment. Claims for such damages should be filed with the freight carrier immediately upon identification.

Claims for defects that are not freight related should be filed with Toro Micro-Irrigation no later than five days from date of discovery of defect within the warranty period as stated below. In order to accurately identify the cause of potential warranty defects, the customer shall provide access to the field, system components, design information, maintenance records, and injected compounds (fertilizers, chemicals, etc.) as requested by Toro.

Toro Micro-Irrigation warranty only covers the Toro product itself, and only applies to defects in material or workmanship in that Toro product; warranty does not cover loss or damage to anything else, or loss or damage to the Toro product caused by anything other than a defect in that Toro product. For example and not by way of limitation, this warranty does not apply to loss or damage to the product, vegetation or other property or personal injury due to improper installation and or application (including non-standard use of product as for example mechanically moved irrigation systems, continuous pressure situations, heated water, waste water, potable water or others), abuse, alteration, mishandling, accident, insects, rodents, mechanical damage, plugging, over pressurization or if the product damage results from service by anyone other than Toro Micro-Irrigation or its authorized service centers or used outside the recommendations of the Toro Micro-Irrigation Owner's Manual.

Many plastic compounds are widely known to be susceptible to environmental stress cracking (ESC) and other forms of material degradation. The use of certain substances may accelerate the process

of ESC and/or material degradation, and would invalidate any Toro product warranty.

Neither Toro Micro-Irrigation nor Toro Warranty Company is liable for failure of products not manufactured by Toro Micro-Irrigation even though such products may be sold or used in conjunction with Toro Micro-Irrigation products.

Neither Toro Micro-Irrigation nor Toro Warranty Company is liable for indirect, incidental, or consequential damages, including but not limited to vegetation or crop loss during periods of malfunction or resulting non-use.

Neither Toro Micro-Irrigation nor Toro Warranty Company is liable for any loss or damage, including property damage resulting from installer's negligence.

This warranty is the only warranty made by Toro Micro-Irrigation or Toro Warranty Company. It replaces all other express warranties and all implied warranties are disclaimed, including the implied warranties of merchantability and fitness for use.

Under this warranty, the sole remedy is to direct all claims to an authorized Toro Micro-Irrigation dealer.

Within the warranty period stated below, Toro Micro-Irrigation and Toro Warranty Company agree to repair or replace, at their option and without charge, any parts which are found to have original manufacturing defects, provided the product is returned freight pre-paid. If the warranty period is longer than two years and products are replaced under the warranty after the second year, the remaining warranty will be prorated for the remaining warranty period, equal to the ratio between the period that has passed prior to replacement and the full warranty period. Toro Micro-Irrigation and Toro Warranty Company do not warranty any labor, including but not limited to labor on installation or removal.

This warranty gives you specific legal rights and you may have other rights, which vary from state to state.

Warranty Period from date of delivery:

Aqua-Traxx® Drip Tape:

- 4, 5 & 6 mil 6 months
- 8 mil 9 months
- 10, 12, 13 & 15 mil18 months

Neptune Flat Emitter Dripline:

- 10, 13 & 15 mil18 months

BlueLine™ Dripline:

- Emitters2 years
- Hose5 years

Drip In® Dripline:

- Emitters2 years
- Hose5 years
- with Rootguard10 years**

Blue Stripe® Hose:

- Oval 42 psi7 years
- Oval 21 psi2 years
- Micro-Distribution7 years
- Round7 years

All Other Hose:1 year*

Fittings:

- All1 year*

Emission Devices:

- All (except NGE®)1 year
- NGE® Emitter2 years

Controllers:

- All5 years

Valves:

- 100, 600, 700 Series5 years
- Bermad® Valves1 year*
- Air Vents1 year*

Mazzei Injectors:

- Airjection®1 year*
- Chemical Injectors1 year*

Filters and components:

- All1 year*

All Other Products1 year*

* Products sold by, but not manufactured by Toro Micro-Irrigation are warranted by their respective manufacturers
** Pro-rated warranty for root intrusion by Geoflow Inc.



Notes



To order, call Toro Micro-Irrigation
El Cajon, Ca: +1 (800) 333-8125 or +1 (619) 562-2950
Sanford, Fl: +1 (800) 806-6582 or +1 (407) 321-2901
List Prices are US\$. FOB Shipping Point. Effective November 19, 2014 (ALT002)

For more product information, visit us at:

toro.com

©2014 The Toro Company

Micro-Irrigation Business

1588 N. Marshall Avenue, El Cajon, CA 92020-1523, USA

Tel: +1 (800) 333-8125 or +1 (619) 562-2950

Fax: +1 (800) 892-1822 or +1 (619) 258-9973

3000 Mellonville Ave., Bldg. 422, Sanford, FL 32773

Tel: +1 (800) 806-6582 or +1 (407) 321-2901

Fax: +1 (800) 314-5328 or +1 (407) 322-8104

toro.com

driptips.toro.com

ALT002 11/14



Count on it.